

# MITSUBISHI THYRISTOR MODULES

## TM90RZ/EZ-M,-H

HIGH POWER GENERAL USE  
INSULATED TYPE

### TM90RZ/EZ-M,-H



- **IT (AV)** Average on-state current ..... **90A**
- **IF (AV)** Average forward current ..... **90A**
- **VRRM** Repetitive peak reverse voltage  
..... **400/800V**
- **VDRM** Repetitive peak off-state voltage  
..... **400/800V**
- **MIX DOUBLE ARMS**
- **Insulated Type**
- **UL Recognized**

Yellow Card No. E80276 (N)  
File No. E80271

### APPLICATION

DC motor control, NC equipment, AC motor control, contactless switches, electric furnace temperature control, light dimmers

### OUTLINE DRAWING & CIRCUIT DIAGRAM

Dimensions in mm

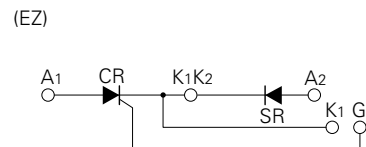
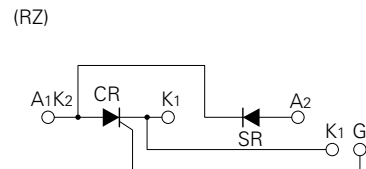
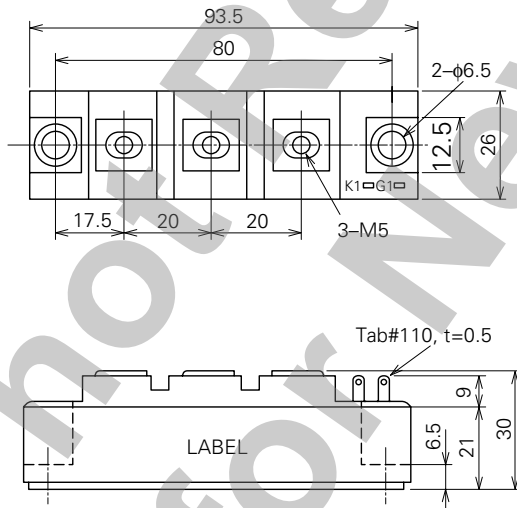

## TM90RZ/EZ-M,-H

HIGH POWER GENERAL USE  
INSULATED TYPE

## ABSOLUTE MAXIMUM RATINGS

Symbol	Parameter	Voltage class		Unit
		M	H	
VRRM	Repetitive peak reverse voltage	400	800	V
VRSM	Non-repetitive peak reverse voltage	480	960	V
VR (DC)	DC reverse voltage	320	640	V
VDRM	Repetitive peak off-state voltage	400	800	V
VDSM	Non-repetitive peak off-state voltage	480	960	V
VD (DC)	DC off-state voltage	320	640	V

Symbol	Parameter	Conditions	Ratings	Unit
$I_{T(RMS)}$ , $I_{F(RMS)}$	RMS current		140	A
$I_T(AV)$ , $I_F(AV)$	Average current	Single-phase, half-wave 180° conduction, $T_c=86^\circ\text{C}$	90	A
$I_{TSM}$ , $I_{FSM}$	Surge (non-repetitive) current	One half cycle at 60Hz, peak value	1800	A
$I^2t$	$I^2t$ for fusing	Value for one cycle of surge current	$1.4 \times 10^4$	$\text{A}^2\text{s}$
$di/dt$	Critical rate of rise of on-state current	$V_D=1/2V_{DRM}$ , $I_G=1.0\text{A}$ , $T_j=125^\circ\text{C}$	100	$\text{A}/\mu\text{s}$
PGM	Peak gate power dissipation		5.0	W
PG(AV)	Average gate power dissipation		0.5	W
VFGM	Peak gate forward voltage		10	V
VRGM	Peak gate reverse voltage		5.0	V
IFGM	Peak gate forward current		2.0	A
$T_j$	Junction temperature		-40~125	$^\circ\text{C}$
$T_{stg}$	Storage temperature		-40~125	$^\circ\text{C}$
$V_{iso}$	Isolation voltage	Charged part to case	2500	V
—	Mounting torque	Main terminal screw M5	1.47~1.96	N·m
			15~20	kg·cm
		Mounting screw M6	1.96~2.94	N·m
			20~30	kg·cm
—	Weight	Typical value	160	g

## ELECTRICAL CHARACTERISTICS

Symbol	Parameter	Test conditions	Limits			Unit
			Min.	Typ.	Max.	
IRRM	Repetitive peak reverse current	$T_j=125^\circ\text{C}$ , $V_{RRM}$ applied	—	—	15	mA
IDRM	Repetitive peak off-state current	$T_j=125^\circ\text{C}$ , $V_{DRM}$ applied	—	—	15	mA
$V_{TM}$ , $V_{FM}$	Forward voltage	$T_j=125^\circ\text{C}$ , $I_{TM}=I_{FM}=270\text{A}$ , instantaneous meas.	—	—	1.3	V
$dv/dt$	Critical rate of rise of off-state voltage	$T_j=125^\circ\text{C}$ , $V_D=2/3V_{DRM}$	500	—	—	$\text{V}/\mu\text{s}$
VGT	Gate trigger voltage	$T_j=25^\circ\text{C}$ , $V_D=6\text{V}$ , $R_L=2\Omega$	—	—	3.0	V
VGD	Gate non-trigger voltage	$T_j=125^\circ\text{C}$ , $V_D=1/2V_{DRM}$	0.25	—	—	V
IGT	Gate trigger current	$T_j=25^\circ\text{C}$ , $V_D=6\text{V}$ , $R_L=2\Omega$	15	—	100	mA
$R_{th(j-c)}$	Thermal resistance	Junction to case (per 1/2 module)	—	—	0.3	$^\circ\text{C}/\text{W}$
$R_{th(c-f)}$	Contact thermal resistance	Case to fin, conductive grease applied (per 1/2 module)	—	—	0.2	$^\circ\text{C}/\text{W}$
—	Insulation resistance	Measured with a 500V megohmmeter between main terminal and case	10	—	—	$\text{M}\Omega$

Note: Items of the above table applies to the Thyristor part and the Diode part as circled in the following tables.

# TM90RZ/EZ-M,-H

HIGH POWER GENERAL USE  
INSULATED TYPE

## MAXIMUM RATINGS

Item	VRRM	VRSM	VR (DC)	VDRM	VDSM	VD (DC)	IT (RMS)	IT (AV)	ITSM	$i^2t$	di/dt
							IF (RMS)	IF (AV)	IFSM		
Thyristor	○	○	○	○	○	○	○	○	○	○	○
Diode	○	○	○	—	—	—	○	○	○	○	—

Item	PGM	PG (AV)	VFGM	IFGM	T <sub>j</sub>	T <sub>stg</sub>
Thyristor	○	○	○	○	○	○
Diode	—	—	—	—	○	○

## ELECTRICAL CHARACTERISTICS

Item	IRRM	IDRM	VTM	dv/dt	VGT	VGD	IGT	R <sub>th(j-c)</sub>	R <sub>th(c-f)</sub>
			VFM						
Thyristor	○	○	○	○	○	○	○	○	○
Diode	○	—	○	—	—	—	—	○	○

## PERFORMANCE CURVES

MAXIMUM FORWARD CHARACTERISTIC

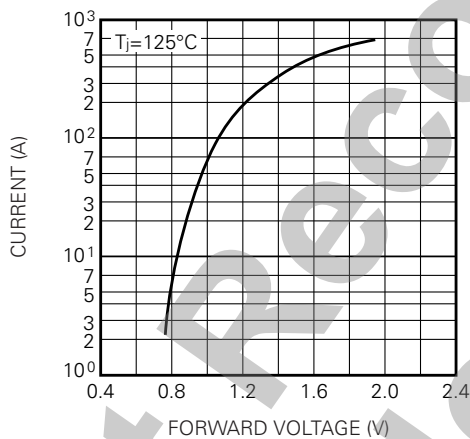

RATED SURGE (NON-REPETITIVE) CURRENT

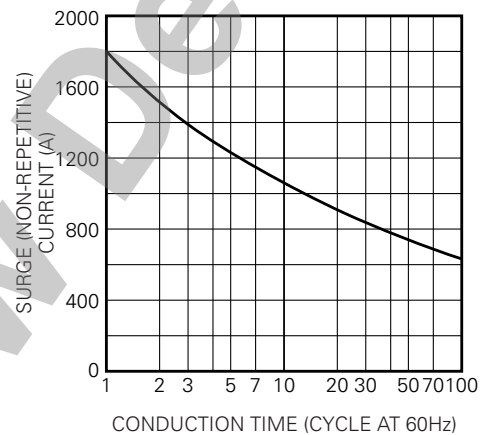

GATE CHARACTERISTICS

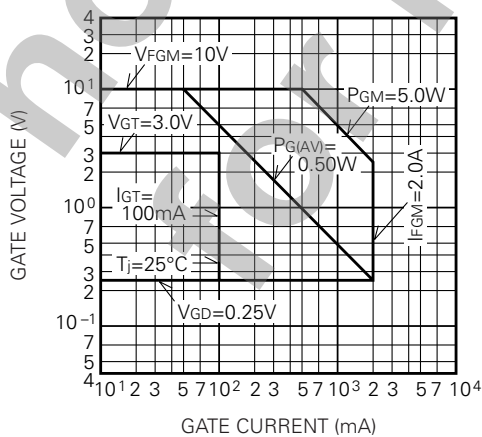

MAXIMUM TRANSIENT THERMAL IMPEDANCE (JUNCTION TO CASE)

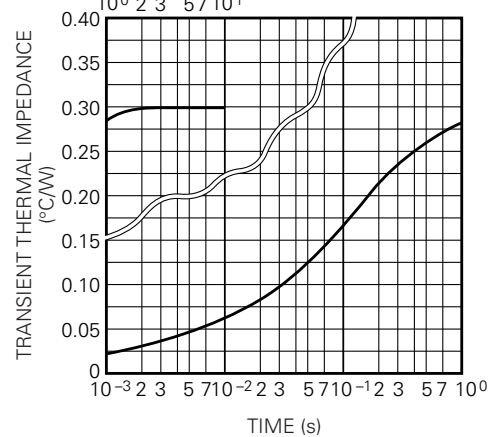

**TM90RZ/EZ-M,-H**

**HIGH POWER GENERAL USE  
INSULATED TYPE**

**MAXIMUM AVERAGE POWER DISSIPATION (SINGLE PHASE HALF WAVE)**

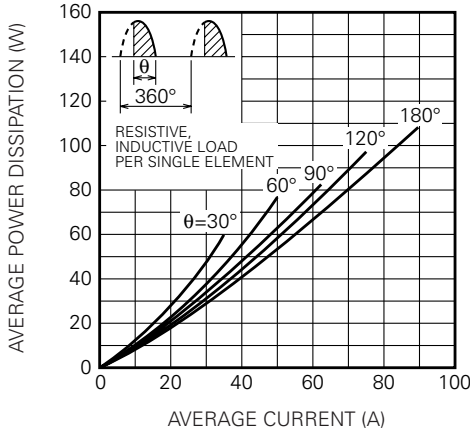

**LIMITING VALUE OF THE AVERAGE CURRENT (SINGLE PHASE HALF WAVE)**

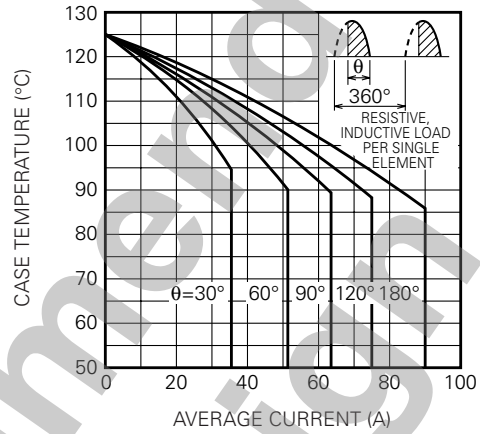

**MAXIMUM AVERAGE POWER DISSIPATION (RECTANGULAR WAVE)**

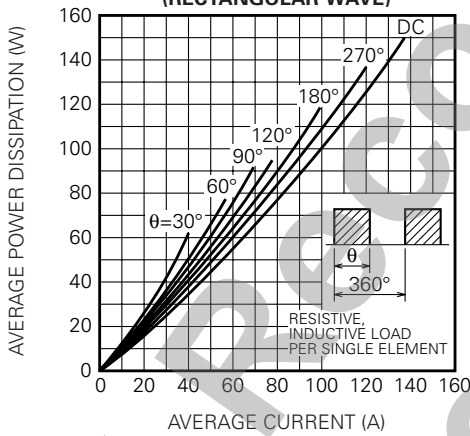

**LIMITING VALUE OF THE AVERAGE CURRENT (RECTANGULAR WAVE)**

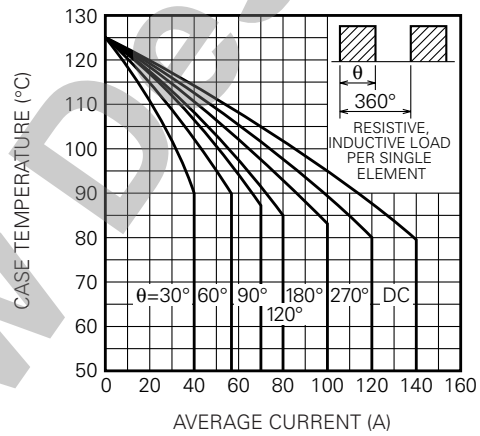

**MAXIMUM AVERAGE POWER DISSIPATION (REVERSE-PARALLEL CONNECTION, THREE-PHASE THREE-LINE CONNECTION)**

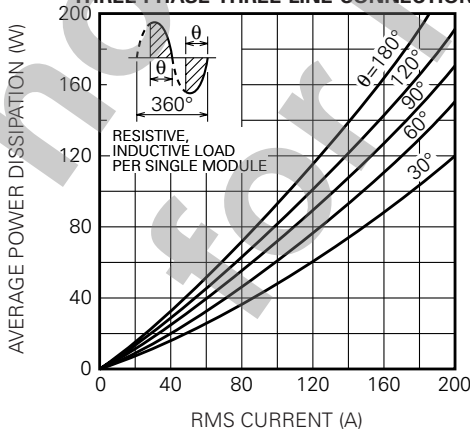

**LIMITING VALUE OF THE RMS CURRENT (REVERSE-PARALLEL CONNECTION, THREE-PHASE THREE-LINE CONNECTION)**

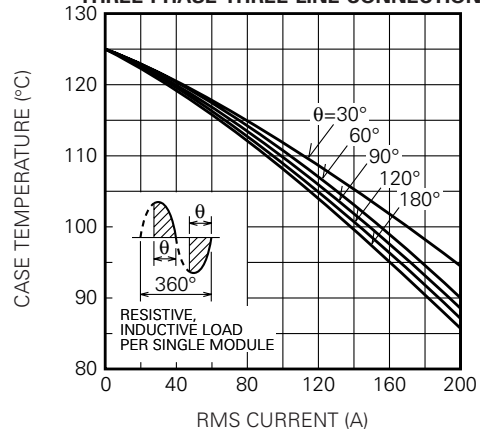

**TM90RZ/EZ-M,-H**

HIGH POWER GENERAL USE  
INSULATED TYPE

**MAXIMUM POWER DISSIPATION  
(SINGLE PHASE FULLWAVE RECTIFIED)**

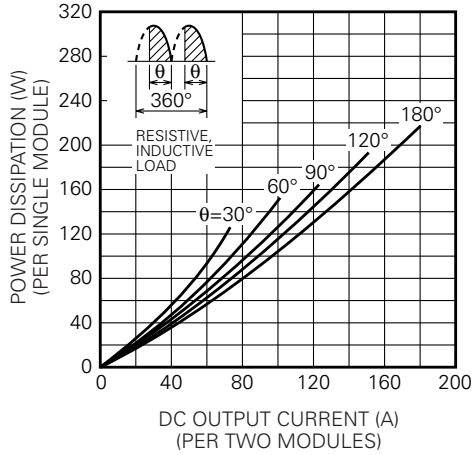

**LIMITING VALUE OF  
THE DC OUTPUT CURRENT  
(SINGLE PHASE FULLWAVE RECTIFIED)**

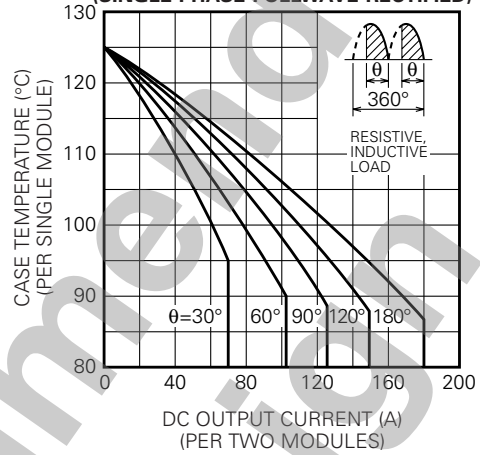

**MAXIMUM POWER DISSIPATION  
(THREE-PHASE FULLWAVE RECTIFIED)**

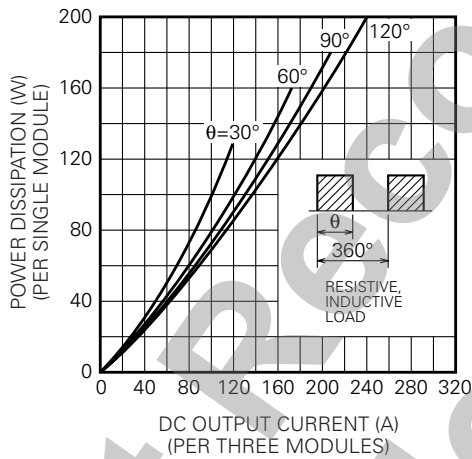

**LIMITING VALUE OF THE DC  
OUTPUT CURRENT  
(THREE-PHASE FULLWAVE RECTIFIED)**

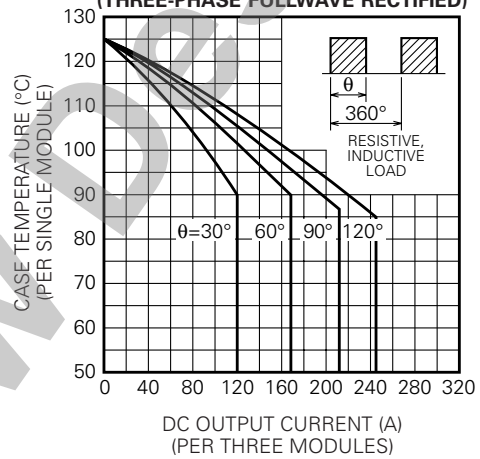

not for New