

MITSUBISHI THYRISTOR MODULES  
**TM55RZ/EZ-24,-2H**

HIGH VOLTAGE MEDIUM POWER GENERAL USE  
 INSULATED TYPE

TM55RZ/EZ-24,-2H



- **IT (AV)** Average on-state current ..... **55A**
- **IF (AV)** Average forward current ..... **55A**
- **VRRM** Repetitive peak reverse voltage  
 .... **1200/1600V**
- **VDRM** Repetitive peak off-state voltage  
 .... **1200/1600V**
- **MIX DOUBLE ARMS**
- **Insulated Type**
- **UL Recognized**

Yellow Card No. E80276 (N)  
 File No. E80271

**APPLICATION**

DC motor control, NC equipment, AC motor control, contactless switches,  
 electric furnace temperature control, light dimmers

**OUTLINE DRAWING & CIRCUIT DIAGRAM**

Dimensions in mm

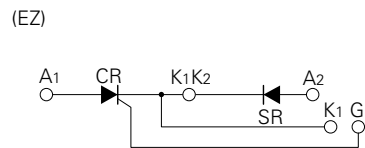
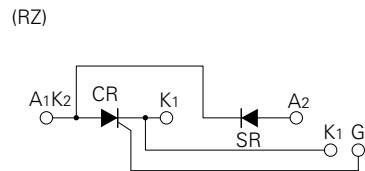
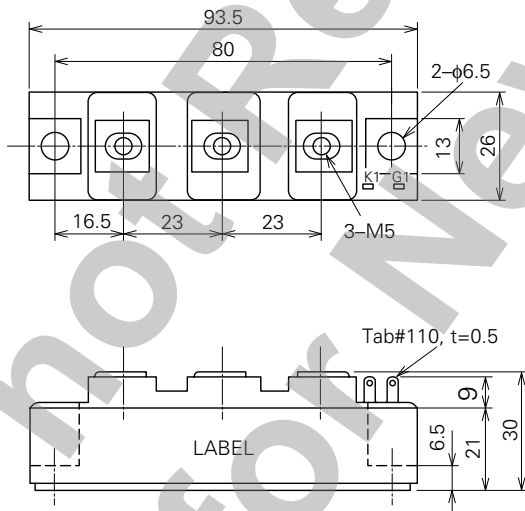

## TM55RZ/EZ-24,-2H

HIGH VOLTAGE MEDIUM POWER GENERAL USE  
INSULATED TYPE

## ABSOLUTE MAXIMUM RATINGS

Symbol	Parameter	Voltage class		Unit
		24	2H	
VRRM	Repetitive peak reverse voltage	1200	1600	V
VRSM	Non-repetitive peak reverse voltage	1350	1700	V
VR (DC)	DC reverse voltage	960	1280	V
VDRM	Repetitive peak off-state voltage	1200	1600	V
VDSM	Non-repetitive peak off-state voltage	1350	1700	V
VD (DC)	DC off-state voltage	960	1280	V

Symbol	Parameter	Conditions	Rated Values	Unit
$I_{T(RMS)}$ , $I_{F(RMS)}$	RMS current		86	A
$I_T(AV)$ , $I_F(AV)$	Average current	Single-phase, half-wave 180° conduction, $T_c=81^\circ\text{C}$	55	A
$I_{TSM}$ , $I_{FSM}$	Surge (non-repetitive) current	One half cycle at 60Hz, peak value	1100	A
$I^2t$	$I^2t$ for fusing	Value for one cycle of surge current	$5.0 \times 10^3$	$\text{A}^2\text{s}$
$di/dt$	Critical rate of rise of on-state current	$V_D=1/2V_{DRM}$ , $I_G=1.0\text{A}$ , $T_j=125^\circ\text{C}$	100	$\text{A}/\mu\text{s}$
PGM	Peak gate power dissipation		5.0	W
PG(AV)	Average gate power dissipation		0.5	W
VFGM	Peak gate forward voltage		10	V
VRGM	Peak gate reverse voltage		5.0	V
IFGM	Peak gate forward current		2.0	A
$T_j$	Junction temperature		-40~125	$^\circ\text{C}$
$T_{stg}$	Storage temperature		-40~125	$^\circ\text{C}$
$V_{iso}$	Isolation voltage	Charged part to case	2500	V
—	Mounting torque	Main terminal screw M5	1.47~1.96	N·m
			15~20	kg·cm
		Mounting screw M6	1.96~2.94	N·m
			20~30	kg·cm
—	Weight	Typical value	160	g

## ELECTRICAL CHARACTERISTICS

Symbol	Parameter	Test conditions	Limits			Unit
			Min.	Typ.	Max.	
IRRM	Repetitive peak reverse current	$T_j=125^\circ\text{C}$ , $V_{RRM}$ applied	—	—	10	mA
IDRM	Repetitive peak off-state current	$T_j=125^\circ\text{C}$ , $V_{DRM}$ applied	—	—	10	mA
$V_{TM}$ , $V_{FM}$	Forward voltage	$T_j=125^\circ\text{C}$ , $I_{TM}=I_{FM}=165\text{A}$ , instantaneous meas.	—	—	1.5	V
$dv/dt$	Critical rate of rise of off-state voltage	$T_j=125^\circ\text{C}$ , $V_D=2/3V_{DRM}$	500	—	—	$\text{V}/\mu\text{s}$
VGT	Gate trigger voltage	$T_j=25^\circ\text{C}$ , $V_D=6\text{V}$ , $R_L=2\Omega$	—	—	2.0	V
VGD	Gate non-trigger voltage	$T_j=125^\circ\text{C}$ , $V_D=1/2V_{DRM}$	0.25	—	—	V
IGT	Gate trigger current	$T_j=25^\circ\text{C}$ , $V_D=6\text{V}$ , $R_L=2\Omega$	15	—	100	mA
$R_{th(j-c)}$	Thermal resistance	Junction to case (per 1/2 module)	—	—	0.5	$^\circ\text{C}/\text{W}$
$R_{th(c-f)}$	Contact thermal resistance	Case to fin, conductive grease applied (per 1/2 module)	—	—	0.2	$^\circ\text{C}/\text{W}$
—	Insulation resistance	Measured with a 500V megohmmeter between main terminal and case	10	—	—	$\text{M}\Omega$

Note: Items of the above table applies to the Thyristor part and the Diode part as circled in the following tables.

# TM55RZ/EZ-24,-2H

HIGH VOLTAGE MEDIUM POWER GENERAL USE  
INSULATED TYPE

## MAXIMUM RATINGS

Item	VRRM	VRSM	VR (DC)	VDRM	VDSM	VD (DC)	IT (RMS)	IT (AV)	ITSM	$i^2t$	di/dt
							IF (RMS)	IF (AV)	IFSM		
Thyristor	○	○	○	○	○	○	○	○	○	○	○
Diode	○	○	○	—	—	—	○	○	○	○	—

Item	PGM	PG (AV)	VFGM	IFGM	T <sub>j</sub>	T <sub>stg</sub>
Thyristor	○	○	○	○	○	○
Diode	—	—	—	—	○	○

## ELECTRICAL CHARACTERISTICS

Item	IRR	IDRM	VTM	dv/dt	VGT	VGD	IGT	R <sub>th(j-c)</sub>	R <sub>th(c-f)</sub>
			VFM						
Thyristor	○	○	○	○	○	○	○	○	○
Diode	○	—	○	—	—	—	—	○	○

## PERFORMANCE CURVES

MAXIMUM FORWARD CHARACTERISTIC

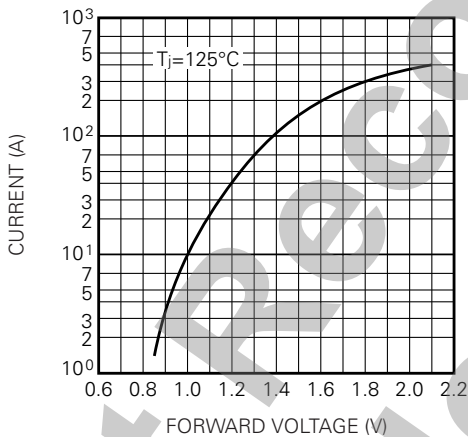

RATED SURGE (NON-REPETITIVE) CURRENT

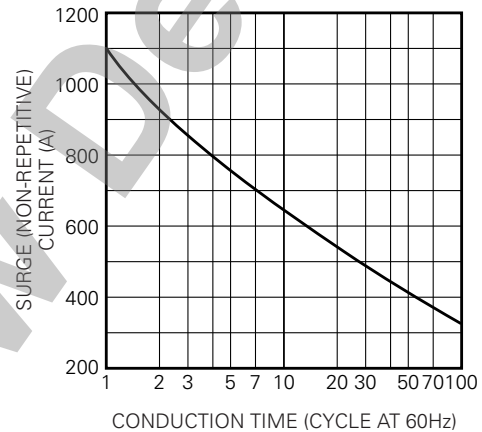

GATE CHARACTERISTICS

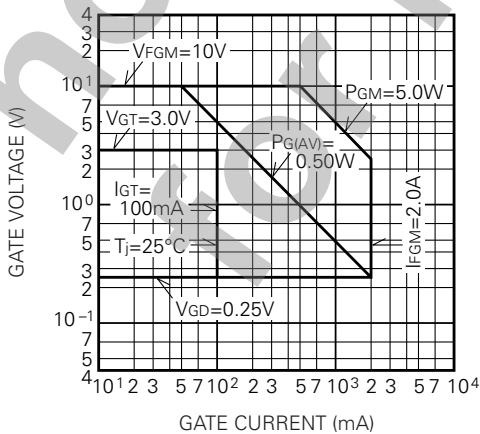

MAXIMUM TRANSIENT THERMAL IMPEDANCE (JUNCTION TO CASE)

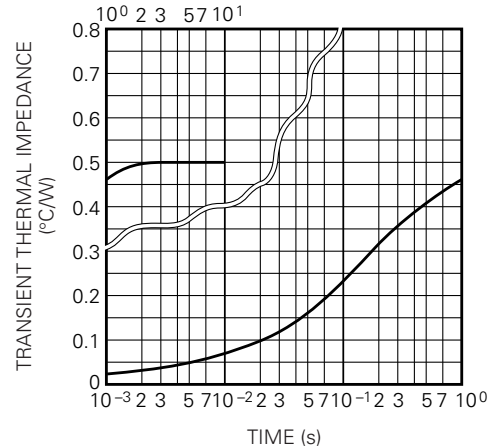

TM55RZ/EZ-24,-2H

HIGH VOLTAGE MEDIUM POWER GENERAL USE  
INSULATED TYPE

MAXIMUM AVERAGE POWER DISSIPATION (SINGLE PHASE HALF WAVE)

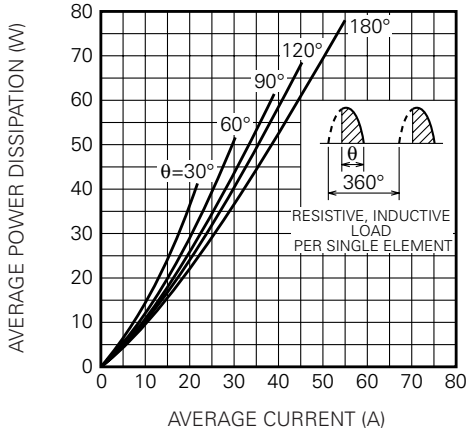

LIMITING VALUE OF THE AVERAGE CURRENT (SINGLE PHASE HALF WAVE)

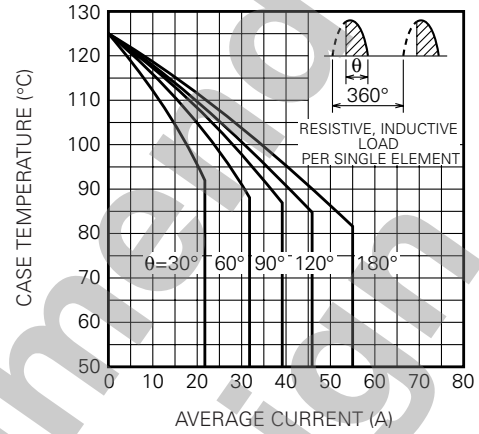

MAXIMUM AVERAGE POWER DISSIPATION (RECTANGULAR WAVE)

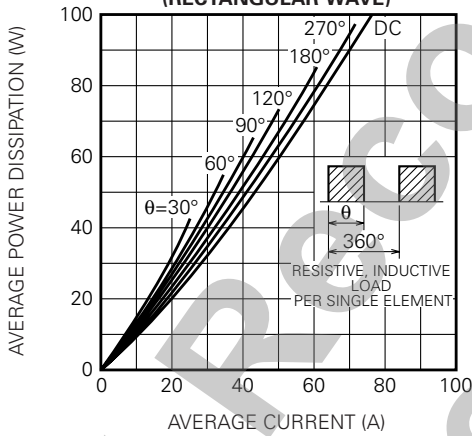

LIMITING VALUE OF THE AVERAGE CURRENT (RECTANGULAR WAVE)

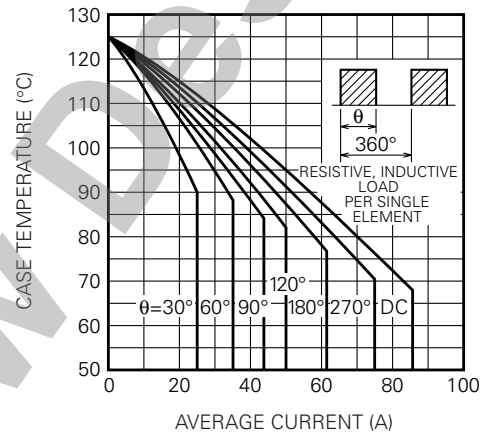

MAXIMUM AVERAGE POWER DISSIPATION (REVERSE-PARALLEL CONNECTION, THREE-PHASE THREE-LINE CONNECTION)

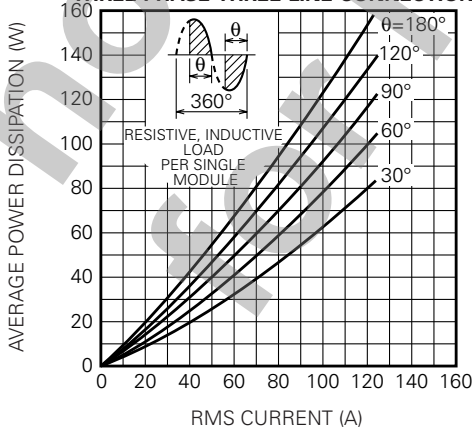

LIMITING VALUE OF THE RMS CURRENT (REVERSE-PARALLEL CONNECTION, THREE-PHASE THREE-LINE CONNECTION)

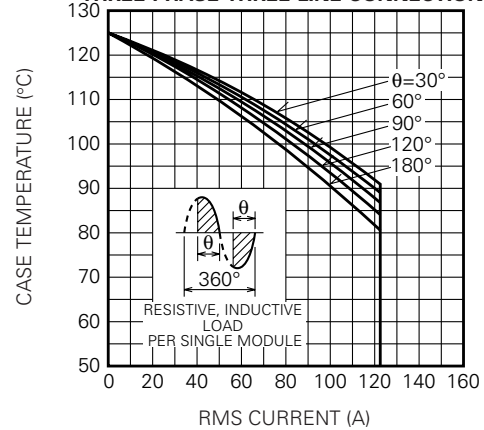

TM55RZ/EZ-24,-2H

HIGH VOLTAGE MEDIUM POWER GENERAL USE  
INSULATED TYPE

MAXIMUM POWER DISSIPATION  
(SINGLE PHASE FULLWAVE RECTIFIED)

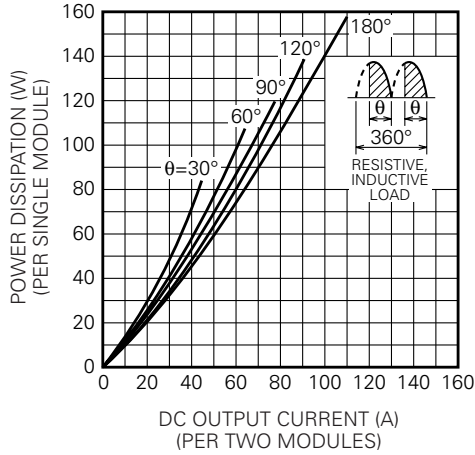

LIMITING VALUE OF  
THE DC OUTPUT CURRENT  
(SINGLE PHASE FULLWAVE RECTIFIED)

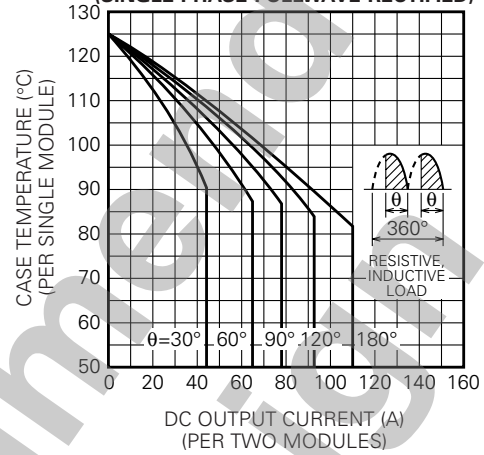

MAXIMUM POWER DISSIPATION  
(THREE-PHASE FULLWAVE RECTIFIED)

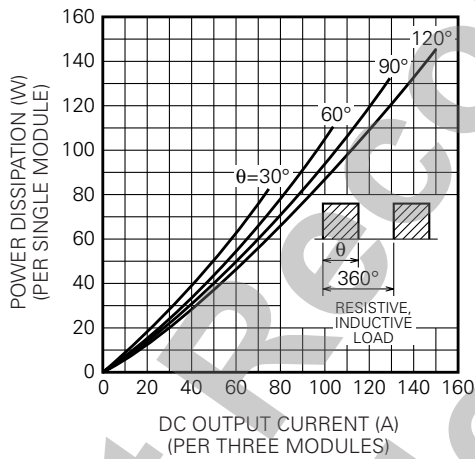

LIMITING VALUE OF THE DC  
OUTPUT CURRENT  
(THREE-PHASE FULLWAVE RECTIFIED)

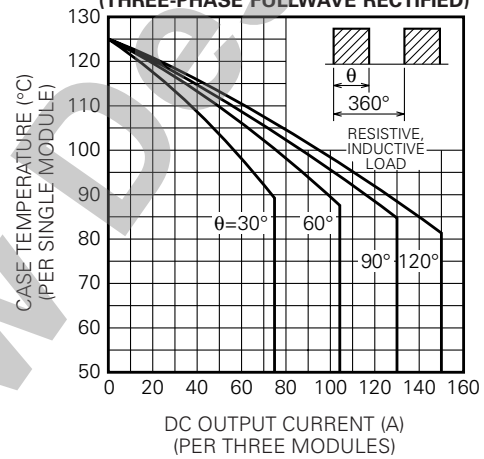

not for New