

MITSUBISHI THYRISTOR MODULES
TM200RZ/EZ/GZ-M,-H,-24,-2H

HIGH POWER GENERAL USE
 INSULATED TYPE

TM200RZ/EZ/GZ-M,-H,24,-2H



(RZ Type)

- **IT (AV)** Average on-state current **200A**
- **IF (AV)** Average forward current **200A**
- **VRRM** Repetitive peak reverse voltage
 **400/800/1200/1600V**
- **VDRM** Repetitive peak off-state voltage
 **400/800/1200/1600V**
- **MIX DOUBLE ARMS**
- **Insulated Type**
- **UL Recognized**

Yellow Card No. E80276 (N)
 File No. E80271

APPLICATION

DC motor control, NC equipment, AC motor control, contactless switches, electric furnace temperature control, light dimmers

OUTLINE DRAWING & CIRCUIT DIAGRAM

Dimensions in mm

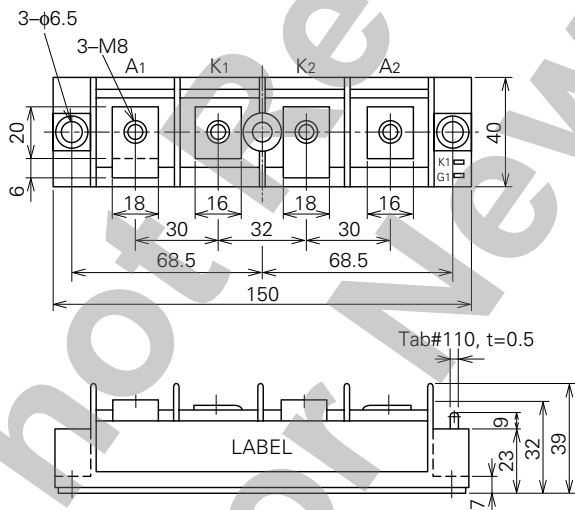

(RZ Type)

(RZ)

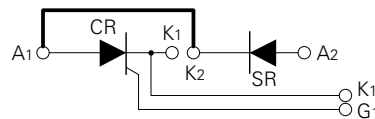

(EZ)

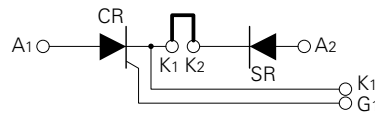

(GZ)

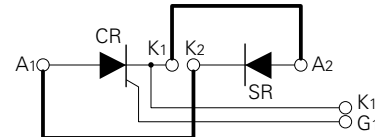

(Bold line is connective bar.)

TM200RZ/EZ/GZ-M,-H,-24,-2H

MEDIUM POWER GENERAL USE
INSULATED TYPE

ABSOLUTE MAXIMUM RATINGS

| Symbol | Parameter | Voltage class | | | | Unit |
|---------|---------------------------------------|---------------|-----|------|------|------|
| | | M | H | 24 | H | |
| VRRM | Repetitive peak reverse voltage | 400 | 800 | 1200 | 1600 | V |
| VRSM | Non-repetitive peak reverse voltage | 480 | 960 | 1350 | 1700 | V |
| VR (DC) | DC reverse voltage | 320 | 640 | 960 | 1280 | V |
| VDRM | Repetitive peak off-state voltage | 400 | 800 | 1200 | 1600 | V |
| VDSM | Non-repetitive peak off-state voltage | 480 | 960 | 1350 | 1700 | V |
| VD (DC) | DC off-state voltage | 320 | 640 | 960 | 1280 | V |

| Symbol | Parameter | Conditions | Ratings | Unit |
|-----------------------------|---|---|-------------------|------------------------|
| $I_{T(RMS)}$, $I_{F(RMS)}$ | RMS current | | 310 | A |
| $I_T(AV)$, $I_F(AV)$ | Average current | Single-phase, half-wave 180° conduction, $T_c=67^\circ\text{C}$ | 200 | A |
| I_{TSM} , I_{FSM} | Surge (non-repetitive) current | One half cycle at 60Hz, peak value | 4000 | A |
| I^2t | I^2t for fusing | Value for one cycle of surge current | 6.7×10^4 | A^2s |
| di/dt | Critical rate of rise of on-state current | $V_D=1/2V_{DRM}$, $I_G=1.0\text{A}$, $T_j=125^\circ\text{C}$ | 100 | $\text{A}/\mu\text{s}$ |
| PGM | Peak gate power dissipation | | 10 | W |
| PG(AV) | Average gate power dissipation | | 3.0 | W |
| VFGM | Peak gate forward voltage | | 10 | V |
| VRGM | Peak gate reverse voltage | | 5.0 | V |
| IFGM | Peak gate forward current | | 4.0 | A |
| T_j | Junction temperature | | -40~125 | $^\circ\text{C}$ |
| T_{stg} | Storage temperature | | -40~125 | $^\circ\text{C}$ |
| V_{iso} | Isolation voltage | Charged part to case | 2500 | V |
| — | Mounting torque | Main terminal screw M8 | 8.83~10.8 | N·m |
| | | | 90~110 | kg·cm |
| | | Mounting screw M6 | 1.96~3.92 | N·m |
| — | Weight | | 20~40 | kg·cm |
| | | Typical value | 300 | g |

ELECTRICAL CHARACTERISTICS

| Symbol | Parameter | Test conditions | Limits | | | Unit |
|---------------------|--|---|--------|------|------|---------------------------|
| | | | Min. | Typ. | Max. | |
| IRRM | Repetitive peak reverse current | $T_j=125^\circ\text{C}$, V_{RRM} applied | — | — | 30 | mA |
| IDRM | Repetitive peak off-state current | $T_j=125^\circ\text{C}$, V_{DRM} applied | — | — | 30 | mA |
| V_{TM} , V_{FM} | Forward voltage | $T_j=125^\circ\text{C}$, $I_{TM}=I_{FM}=600\text{A}$, instantaneous meas. | — | — | 1.35 | V |
| dv/dt | Critical rate of rise of off-state voltage | $T_j=125^\circ\text{C}$, $V_D=2/3V_{DRM}$ | 500 | — | — | $\text{V}/\mu\text{s}$ |
| VGT | Gate trigger voltage | $T_j=25^\circ\text{C}$, $V_D=6\text{V}$, $R_L=2\Omega$ | — | — | 3.0 | V |
| VGD | Gate non-trigger voltage | $T_j=125^\circ\text{C}$, $V_D=1/2V_{DRM}$ | 0.25 | — | — | V |
| IGT | Gate trigger current | $T_j=25^\circ\text{C}$, $V_D=6\text{V}$, $R_L=2\Omega$ | 15 | — | 100 | mA |
| $R_{th(j-c)}$ | Thermal resistance | Junction to case (per 1/2 module) | — | — | 0.2 | $^\circ\text{C}/\text{W}$ |
| $R_{th(c-f)}$ | Contact thermal resistance | Case to fin, conductive grease applied (per 1/2 module) | — | — | 0.1 | $^\circ\text{C}/\text{W}$ |
| — | Insulation resistance | Measured with a 500V megohmmeter between main terminal and case | 10 | — | — | $\text{M}\Omega$ |

Note: Items of the above table applies to the Thyristor part and the Diode part as circled in the following tables.

TM200RZ/EZ/GZ-M,-H,-24,-2H

HIGH POWER GENERAL USE
INSULATED TYPE

MAXIMUM RATINGS

| Item | VRRM | VRSM | VR (DC) | VDRM | VDSM | VD (DC) | IT (RMS) | IT (AV) | ITSM | i^2t | di/dt |
|-----------|------|------|---------|------|------|---------|----------|---------|------|--------|-------|
| | | | | | | | IF (RMS) | IF (AV) | IFSM | | |
| Thyristor | ○ | ○ | ○ | ○ | ○ | ○ | ○ | ○ | ○ | ○ | ○ |
| Diode | ○ | ○ | ○ | — | — | — | ○ | ○ | ○ | ○ | — |

| Item | PGM | PG (AV) | VFGM | IFGM | Tj | Tstg |
|-----------|-----|---------|------|------|----|------|
| Thyristor | ○ | ○ | ○ | ○ | ○ | ○ |
| Diode | — | — | — | — | ○ | ○ |

ELECTRICAL CHARACTERISTICS

| Item | IRRM | IDRM | VTM | dv/dt | VGT | VGD | IGT | Rth (j-c) | Rth (c-f) |
|-----------|------|------|-----|-------|-----|-----|-----|-----------|-----------|
| | | | VFM | | | | | | |
| Thyristor | ○ | ○ | ○ | ○ | ○ | ○ | ○ | ○ | ○ |
| Diode | ○ | — | ○ | — | — | — | — | ○ | ○ |

PERFORMANCE CURVES

MAXIMUM FORWARD CHARACTERISTIC

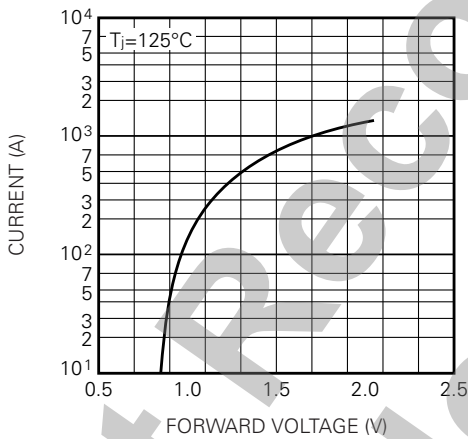

RATED SURGE (NON-REPETITIVE) CURRENT

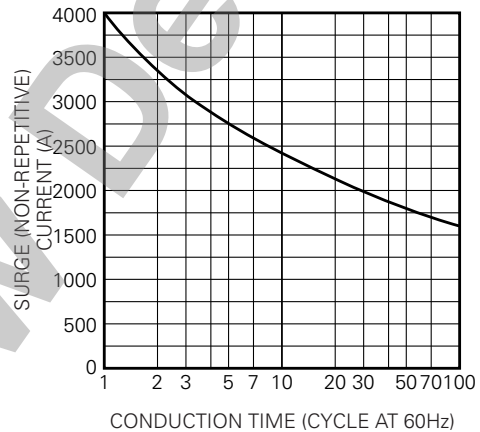

GATE CHARACTERISTICS

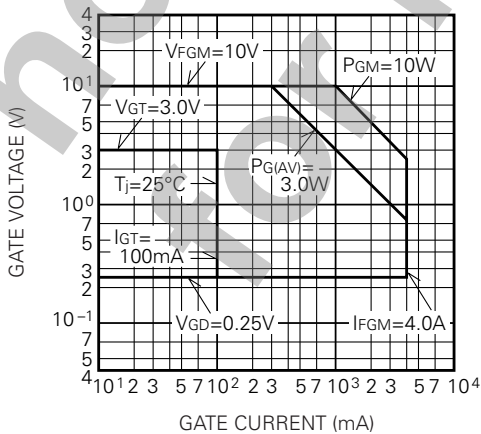

MAXIMUM TRANSIENT THERMAL IMPEDANCE (JUNCTION TO CASE)

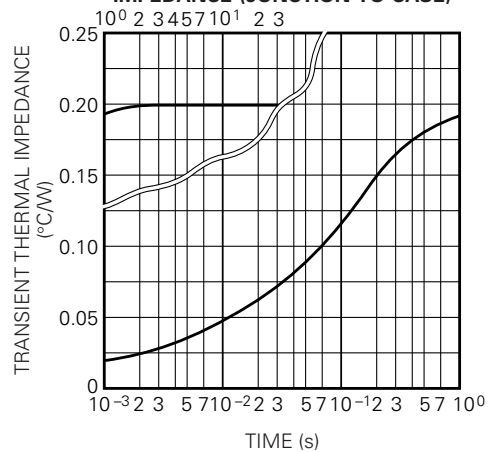

TM200RZ/EZ/GZ-M,-H,-24,-2H

HIGH POWER GENERAL USE
INSULATED TYPE

MAXIMUM AVERAGE POWER DISSIPATION (SINGLE PHASE HALF WAVE)

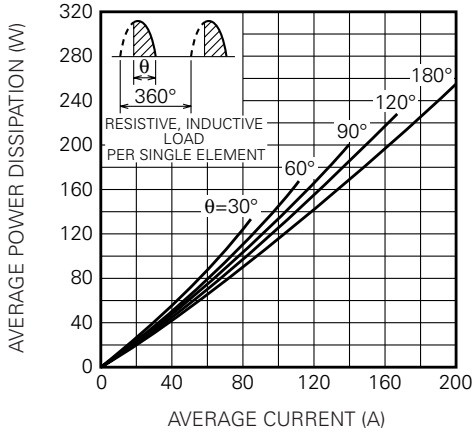

LIMITING VALUE OF THE AVERAGE CURRENT (SINGLE PHASE HALF WAVE)

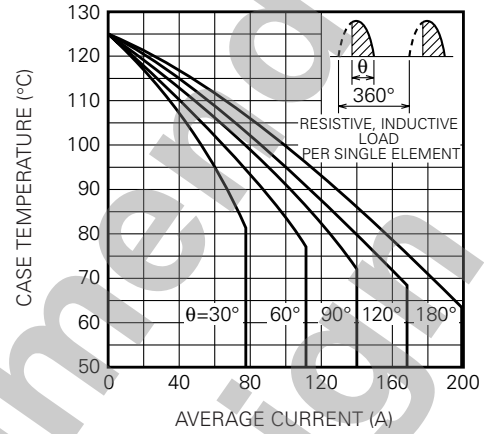

MAXIMUM AVERAGE POWER DISSIPATION (RECTANGULAR WAVE)

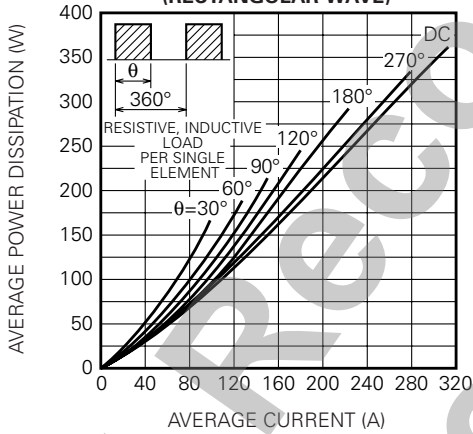

LIMITING VALUE OF THE AVERAGE CURRENT (RECTANGULAR WAVE)

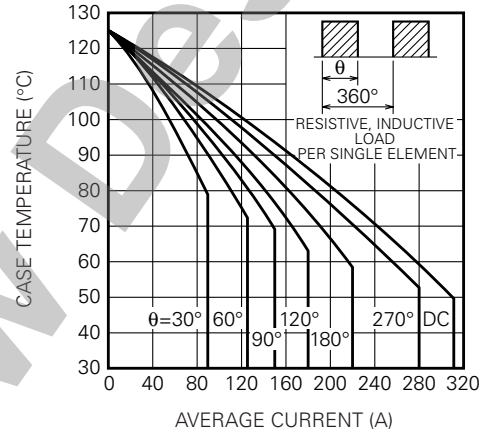

not for New