

MITSUBISHI THYRISTOR MODULES
TM130DZ/CZ/PZ-24,-2H

HIGH POWER GENERAL USE
 INSULATED TYPE

TM130DZ/CZ/PZ-24,-2H



(DZ Type)

- **IT (AV)** Average on-state current **130A**
- **VRRM** Repetitive peak reverse voltage
 **1200/1600V**
- **VDRM** Repetitive peak off-state voltage
 **1200/1600V**
- **DOUBLE ARMS**
- **Insulated Type**
- **UL Recognized**

Yellow Card No. E80276 (N)
 File No. E80271

APPLICATION

DC motor control, NC equipment, AC motor control, Contactless switches,
 Electric furnace temperature control, Light dimmers

OUTLINE DRAWING & CIRCUIT DIAGRAM

Dimensions in mm

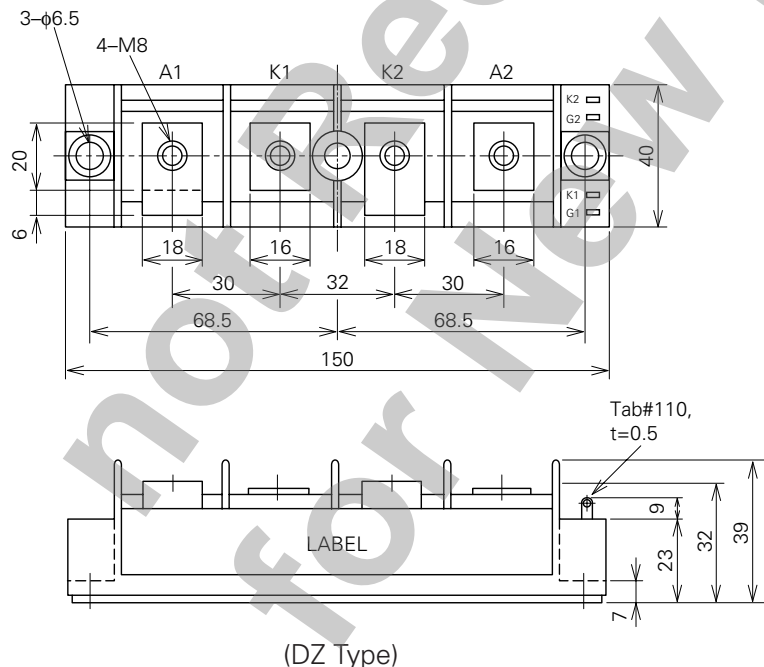

(DZ)

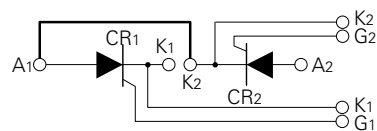

(CZ)

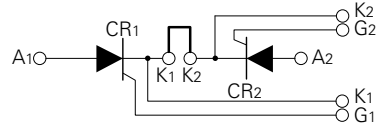

(PZ)

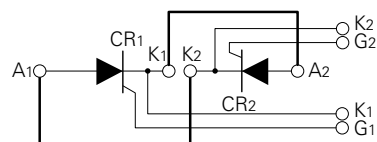

(Bold line is connective bar.)

TM130DZ/CZ/PZ-24,-2H

HIGH POWER GENERAL USE

INSULATED TYPE

ABSOLUTE MAXIMUM RATINGS

| Symbol | Parameter | Voltage class | | Unit |
|---------|---------------------------------------|---------------|------|------|
| | | 24 | 2H | |
| VRRM | Repetitive peak reverse voltage | 1200 | 1600 | V |
| VRSM | Non-repetitive peak reverse voltage | 1350 | 1700 | V |
| VR (DC) | DC reverse voltage | 960 | 1280 | V |
| VDRM | Repetitive peak off-state voltage | 1200 | 1600 | V |
| VDSM | Non-repetitive peak off-state voltage | 1350 | 1700 | V |
| VD (DC) | DC off-state voltage | 960 | 1280 | V |

| Symbol | Parameter | Conditions | Ratings | Unit |
|------------------|---|---|-----------------------|------------------|
| IT (RMS) | RMS on-state current | | 205 | A |
| IT (AV) | Average on-state current | Single-phase, half-wave 180° conduction, Tc=78°C | 130 | A |
| ITSM | Surge (non-repetitive) on-state current | One half cycle at 60Hz, peak value | 2600 | A |
| I ² t | I ² t for fusing | Value for one cycle of surge current | 2.8 × 10 ⁴ | A ² s |
| di/dt | Critical rate of rise of on-state current | V _D =1/2V _{DRM} , I _G =1.0A, T _j =125°C | 100 | A/μs |
| PGM | Peak gate power dissipation | | 10 | W |
| PG (AV) | Average gate power dissipation | | 3.0 | W |
| VFGM | Peak gate forward voltage | | 10 | V |
| VRGM | Peak gate reverse voltage | | 5.0 | V |
| IFGM | Peak gate forward current | | 4.0 | A |
| T _j | Junction temperature | | -40~+125 | °C |
| T _{stg} | Storage temperature | | -40~+125 | °C |
| V _{iso} | Isolation voltage | Charged part to case | 2500 | V |
| — | Mounting torque | Main terminal screw M8 | 8.83~10.8 | N·m |
| | | | 90~110 | kg·cm |
| | | Mounting screw M6 | 1.96~3.92 | N·m |
| — | Weight | | 20~40 | kg·cm |
| | | Typical value | 300 | g |

ELECTRICAL CHARACTERISTICS

| Symbol | Parameter | Test conditions | Limits | | | Unit |
|-----------------------|--|---|--------|------|------|------|
| | | | Min. | Typ. | Max. | |
| I _{RRM} | Repetitive peak reverse current | T _j =125°C, V _{RRM} applied | — | — | 30 | mA |
| I _{DRM} | Repetitive peak off-state current | T _j =125°C, V _{DRM} applied | — | — | 30 | mA |
| V _{TM} | On-state voltage | T _j =125°C, I _{TM} =390A, instantaneous meas. | — | — | 1.5 | V |
| dv/dt | Critical rate of rise of off-state voltage | T _j =125°C, V _D =2/3V _{DRM} | 500 | — | — | V/μs |
| V _{GT} | Gate trigger voltage | T _j =25°C, V _D =6V, R _L =2Ω | — | — | 3.0 | V |
| V _{GD} | Gate non-trigger voltage | T _j =125°C, V _D =1/2V _{DRM} | 0.25 | — | — | V |
| I _{GT} | Gate trigger current | T _j =25°C, V _D =6V, R _L =2Ω | 15 | — | 100 | mA |
| R _{th (j-c)} | Thermal resistance | Junction to case (per 1/2 module) | — | — | 0.22 | °C/W |
| R _{th (c-f)} | Contact thermal resistance | Case to fin, conductive grease applied (per 1/2 module) | — | — | 0.1 | °C/W |
| — | Insulation resistance | Measured with a 500V megohmmeter between main terminal and case | 10 | — | — | MΩ |

TM130DZ/CZ/PZ-24,-2H

HIGH POWER GENERAL USE

INSULATED TYPE

PERFORMANCE CURVES

MAXIMUM ON-STATE CHARACTERISTIC

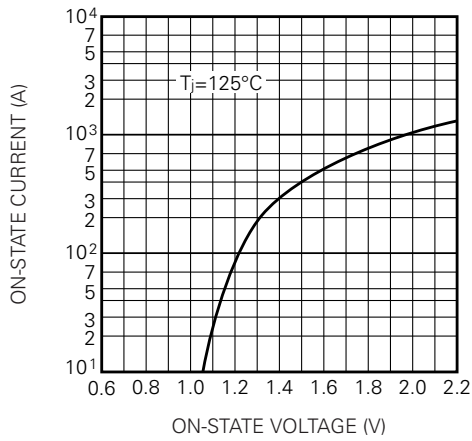

RATED SURGE (NON-REPETITIVE) ON-STATE CURRENT

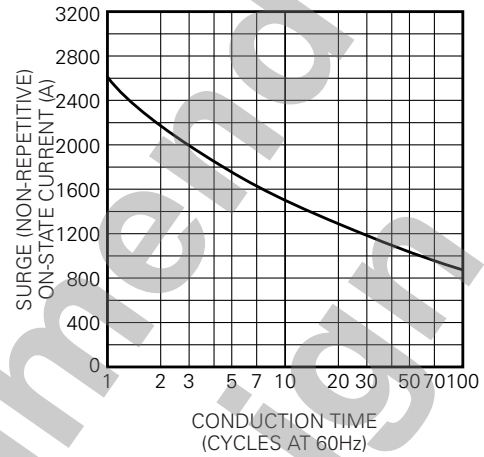

GATE CHARACTERISTICS

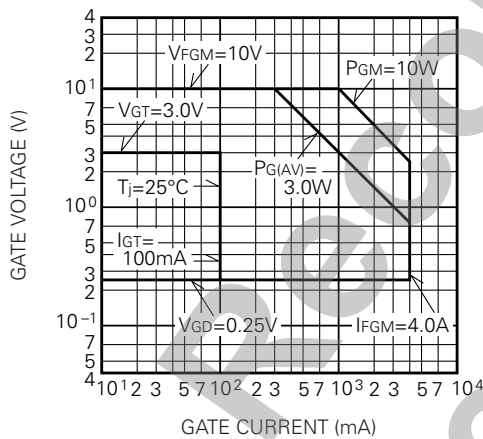

MAXIMUM TRANSIENT THERMAL IMPEDANCE (JUNCTION TO CASE)

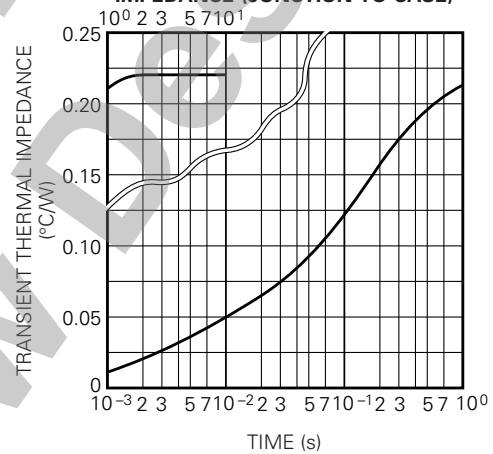

MAXIMUM AVERAGE ON-STATE POWER DISSIPATION (SINGLE PHASE HALF WAVE)

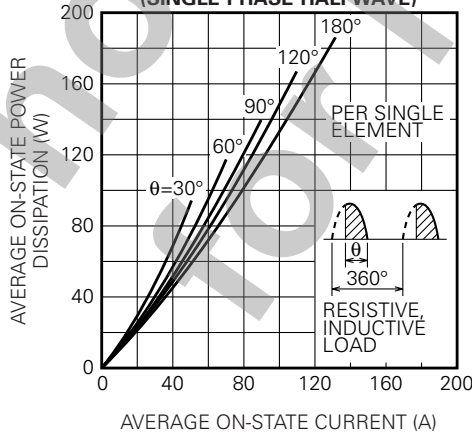

LIMITING VALUE OF THE AVERAGE ON-STATE CURRENT (SINGLE PHASE HALF WAVE)

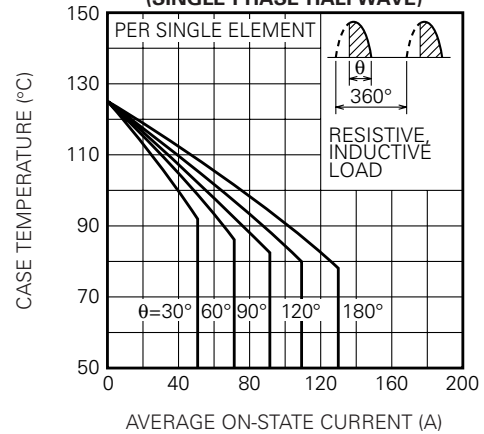

TM130DZ/CZ/PZ-24,-2H

HIGH POWER GENERAL USE
INSULATED TYPE

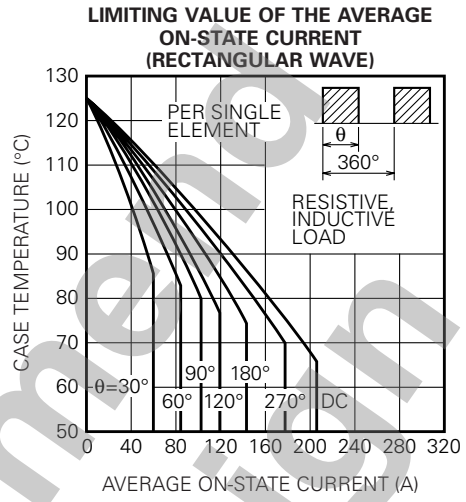
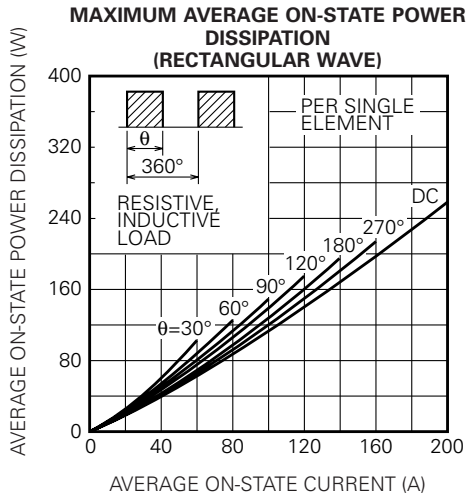

not Recommended for New Design