

TM10T3B-M,-H

MEDIUM POWER GENERAL USE
INSULATED TYPE

TM10T3B-M,-H



- **I_o** DC output current **20A**
- **V_{RRM}** Repetitive peak reverse voltage **400/800V**
- **V_{DRM}** Repetitive peak off-state voltage **400/800V**
- **3 Phase Mix Bridge**
- **Insulated Type**
- **UL Recognized**
Yellow Card No. E80276 (N)
File No. E80271

APPLICATION

DC motor control, NC equipment, AC motor control, contactless switches, electric furnace temperature control, light dimmers

OUTLINE DRAWING & CIRCUIT DIAGRAM

Dimensions in mm

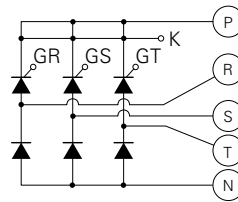
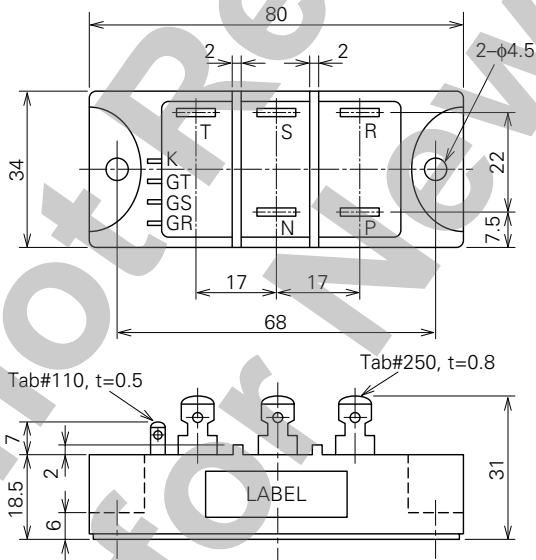

TM10T3B-M,-H

MEDIUM POWER GENERAL USE
INSULATED TYPE

ABSOLUTE MAXIMUM RATINGS

Symbol	Parameter	Voltage class		Unit
		M	H	
VRRM	Repetitive peak reverse voltage	400	800	V
VRSM	Non-repetitive peak reverse voltage	480	960	V
VR (DC)	DC reverse voltage	320	640	V
VDRM	Repetitive peak off-state voltage	400	800	V
VDSM	Non-repetitive peak off-state voltage	480	960	V
VD (DC)	DC off-state voltage	320	640	V

Symbol	Parameter	Conditions	Ratings	Unit
Io	DC output current	3-phase fullwave rectified, TC=79°C	20	A
ITSM, IFSM	Surge (non-repetitive) current	One half cycle at 60Hz, peak value	200	A
I ² t	I ² t for fusing	Value for one cycle of surge current	1.7 × 10 ²	A ² s
di/dt	Critical rate of rise of on-state current	V _D =1/2V _{DRM} , I _G =0.5A, T _j =125°C	50	A/μs
PGM	Peak gate power dissipation		5.0	W
PG (AV)	Average gate power dissipation		0.5	W
VFGM	Peak gate forward voltage		10	V
VRGM	Peak gate reverse voltage		5.0	V
IFGM	Peak gate forward current		2.0	A
T _j	Junction temperature		-40~125	°C
T _{stg}	Storage temperature		-40~125	°C
Viso	Isolation voltage	Charged part to case	2500	V
—	Mounting torque	Mounting screw M4	0.98~1.47	N·m
—	Weight	Typical value	10~15	kg·cm
—	Weight	Typical value	130	g

ELECTRICAL CHARACTERISTICS

Symbol	Parameter	Test conditions	Limits			Unit
			Min.	Typ.	Max.	
IRRM	Repetitive peak reverse current	T _j =125°C, VRRM applied	—	—	4.0	mA
IDRM	Repetitive peak off-state current	T _j =125°C, VDRM applied	—	—	4.0	mA
VTM, VFM	Forward voltage	T _j =125°C, I _{TM} =I _{FM} =20A, instantaneous meas.	—	—	1.3	V
dv/dt	Critical rate of rise of off-state voltage	T _j =125°C, V _D =2/3V _{DRM}	500	—	—	V/μs
VGT	Gate trigger voltage	T _j =25°C, V _D =6V, R _L =2Ω	—	—	2.0	V
VGD	Gate non-trigger voltage	T _j =125°C, V _b =1/2V _{DRM}	0.25	—	—	V
IGT	Gate trigger current	T _j =25°C, V _D =6V, R _L =2Ω	10	—	50	mA
R _{th (j-c)}	Thermal resistance	Junction to case (per 1/6 module)	—	—	4.5	°C/W
R _{th (c-f)}	Contact thermal resistance	Case to fin, Conductive grease applied (per 1/6 module)	—	—	0.6	°C/W
—	Insulation resistance	Measured with a 500V megohmmeter between main terminal and case	10	—	—	MΩ

Note: Items of the above table applies to the Thyristor part and the Diode part as circled in the following tables.

TM10T3B-M,-H

MEDIUM POWER GENERAL USE
INSULATED TYPE

MAXIMUM RATINGS

Item	VRRM	VRSM	VR (DC)	VDRM	VDSM	VD (DC)	IT (RMS)	IT (AV)	ITSM	I^2t	di/dt
							IF (RMS)	IF (AV)	IFSM		
Thyristor	○	○	○	○	○	○	○	○	○	○	○
Diode	○	○	○	—	—	—	○	○	○	○	—

Item	PGM	PG (AV)	VFGM	IFGM	T _j	T _{stg}
Thyristor	○	○	○	○	○	○
Diode	—	—	—	—	○	○

ELECTRICAL CHARACTERISTICS

Item	IRR _M	IDRM	VTM	dv/dt	VGT	VGB	IGT	R _{th(j-c)}	R _{th(c-f)}
			VFM						
Thyristor	○	○	○	○	○	○	○	○	○
Diode	○	—	○	—	—	—	—	○	○

PERFORMANCE CURVES

MAXIMUM FORWARD CHARACTERISTIC

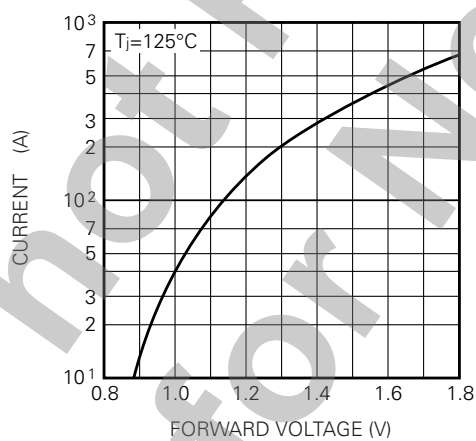

RATED SURGE (NON-REPETITIVE) CURRENT

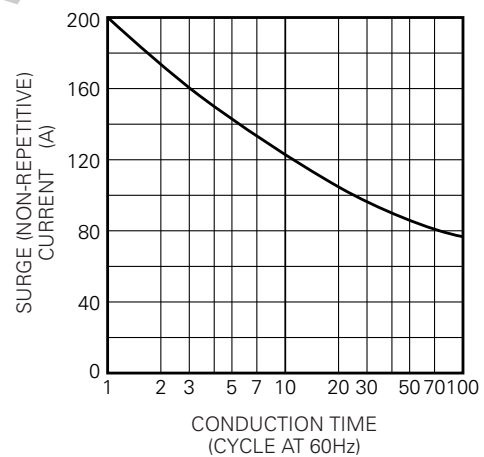

TM10T3B-M,-H

MEDIUM POWER GENERAL USE
INSULATED TYPE

MAXIMUM TRANSIENT THERMAL IMPEDANCE (JUNCTION TO CASE) (PER SINGLE ELEMENT)

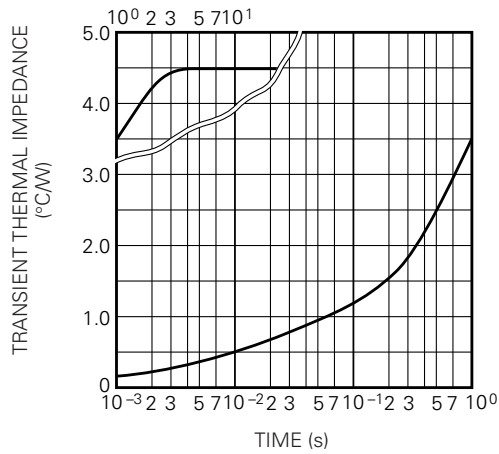

MAXIMUM POWER DISSIPATION (THREE PHASE FULLWAVE RECTIFIED)

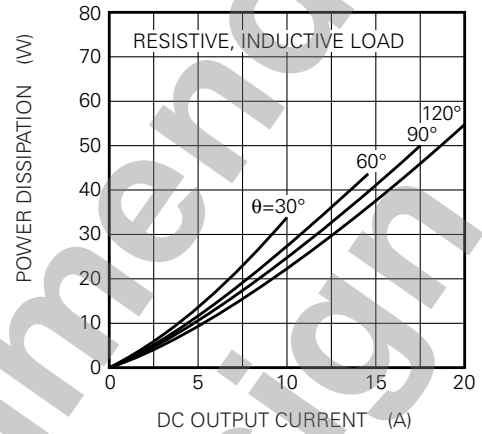

LIMITING VALUE OF THE DC OUTPUT CURRENT (THREE PHASE FULLWAVE RECTIFIED)

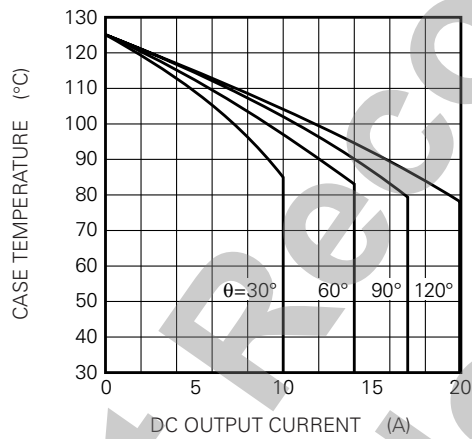

not Recommended for New Design