

Powerex, Inc., 200 Hillis Street, Youngwood, Pennsylvania 15697-1800 (412) 925-7272  
 Powerex, Europe, S.A. 428 Avenue G. Durand, BP107, 72003 Le Mans, France (43) 41.14.14

**Phase Control SCR**  
**3500 Amperes Average**  
**600 Volts**

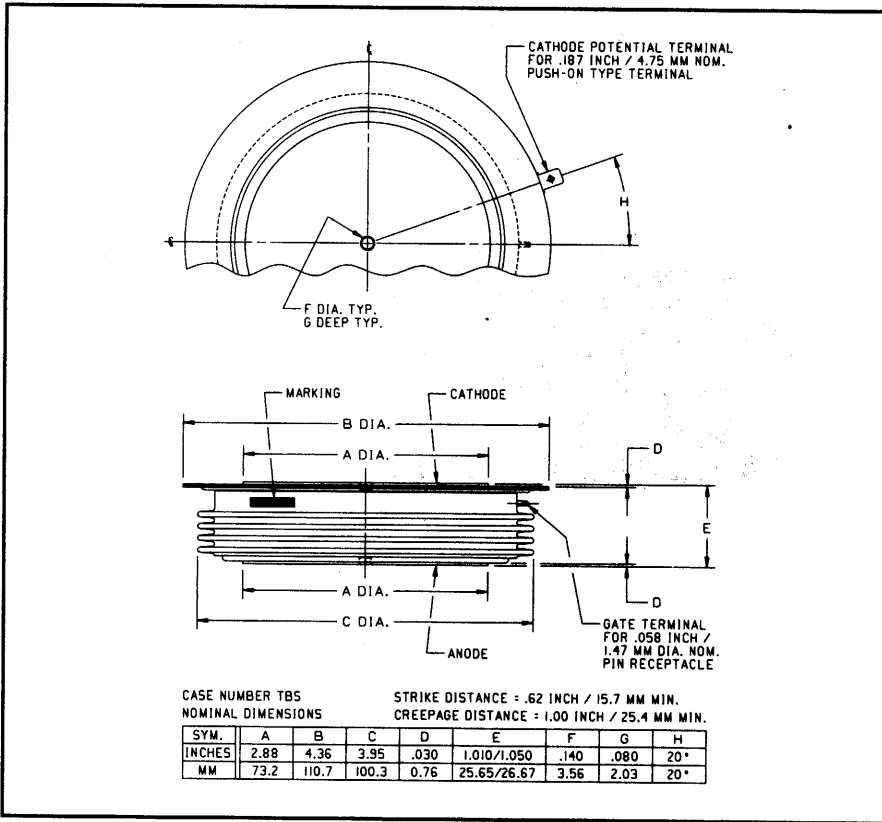

TBS7 3500A (Outline Drawing)

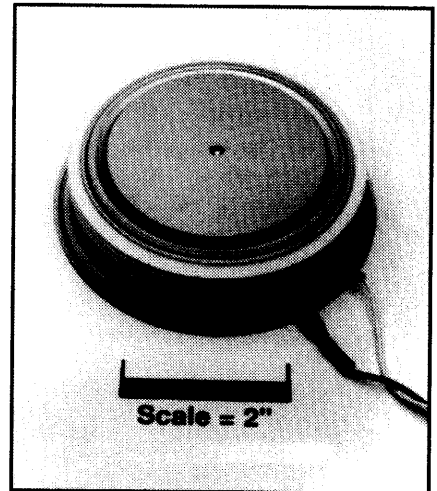

TBS7 3500A Phase Control SCR  
 3500 Amperes Average, 600 Volts

**Description:**

The TBS7 is a low voltage, high current version of the Powerex C781 in a thin, low profile package with improved thermal capability for increased current capacity. Powerex Silicon Controlled Rectifiers (SCR) are designed for phase control applications. These are all-diffused, Press-Pak, hermetic Pow-R-Disc devices employing the field proven amplifying gate.

**Features:**

- Very Low On-State Voltage
- High di/dt Capability
- High dv/dt Capability
- Hermetic Packaging
- Excellent Surge and  $I^2t$  Ratings
- Thin Package (26mm) for Higher Current Capability.

**Applications:**

- Power Supplies
- Motor Control
- Battery Chargers

**Ordering Information:**

Select the complete 12 digit part number you desire from the table below.

Type	Voltage	Current	Turn-off	Gate Current	Lead Code
	$V_{DRM}/V_{RRM}$ (Volts)	$I_{T(av)}$ (A)	$t_q$ ( $\mu$ sec)	$I_{GT}$ (mA)	
TBS7	02 04 06  200V 400V 600V	35   3500A	0   400 $\mu$ sec (Typical)	H   250mA	HE   20"



Powerex, Inc., 200 Hillis Street, Youngwood, Pennsylvania 15697-1800 (412) 925-7272  
 Powerex, Europe, S.A. 428 Avenue G. Durand, BP107, 72003 Le Mans, France (43) 41.14.14

**TBS7 3500A**  
**Phase Control SCR**  
 3500 Amperes Average, 600 Volts

### Absolute Maximum Ratings

Characteristics	Symbol	TBS7 3500A	Units
Non-repetitive Transient Peak Reverse Voltage	$V_{RSM}$	$V_{RRM} + 100V$	Volts
RMS On-state Current, $T_C = 72^\circ C$	$I_{T(rms)}$	5600	Amperes
Average Current 180° Sine Wave, $T_C = 72^\circ C$	$I_{T(av)}$	3500	Amperes
RMS On-state Current, $T_C = 55^\circ C$	$I_{T(rms)}$	6595	Amperes
Average Current 180° Sine Wave, $T_C = 55^\circ C$	$I_{T(av)}$	4200	Amperes
Peak One Cycle Surge On-state Current (Non-repetitive) 60Hz	$I_{tsm}$	48000	Amperes
Peak One Cycle Surge On-state Current (Non-repetitive) 50Hz	$I_{tsm}$	44200	Amperes
Critical Rate-of-rise of On-state Current (Non-repetitive)	$di/dt$	600	A/ $\mu$ sec
Critical Rate-of-rise of On-state Current (Repetitive)	$di/dt$	100	A/ $\mu$ sec
$I^2t$ (for Fusing) for One Cycle, 60Hz	$i^2t$	$9.6 \times 10^6$	A <sup>2</sup> sec
Peak Gate Power Dissipation	$P_{GM}$	250	Watts
Average Gate Power Dissipation	$P_{G(av)}$	35	Watts
Operating Temperature	$T_j$	-40 to +125°C	°C
Storage Temperature	$T_{stg}$	-40 to +150°C	°C
Approximate Weight		2.5	lb.
		1.1	kg
Mounting Force		6000 to 10000	lb.
		26.6 to 44.4	kN



Powerex, Inc., 200 Hillis Street, Youngwood, Pennsylvania 15697-1800 (412) 925-7272  
 Powerex, Europe, S.A. 428 Avenue G. Durand, BP107, 72003 Le Mans, France (43) 41.14.14

**TBS7 3500A**

**Phase Control SCR**

3500 Amperes Average, 600 Volts

**Electrical Characteristics,  $T_j = 25^\circ\text{C}$  Unless Otherwise Specified**

Characteristics	Symbol	Test Conditions	Min.	Typ.	Max.	Units
Repetitive Peak Reverse Leakage Current	$I_{RRM}$	$T_j = 125^\circ\text{C}, V_R = V_{RRM}$			150	mA
Repetitive Peak Forward Leakage Current	$I_{DRM}$	$T_j = 125^\circ\text{C}, V_D = V_{DRM}$			150	mA
Peak On-state Voltage	$V_{TM}$	$I_{TM} = 3000\text{A Peak}$ Duty Cycle < 0.01%			1.05	Volts
Threshold Voltage, Low-level	$V_{(TO)1}$	$T_j = 125^\circ\text{C}, I = 15\%, I_{T(av)}$ to $\pi I_{T(av)}$			0.6917	Volts
Slope Resistance, Low-level	$r_{T1}$				0.08747	m $\Omega$
Threshold Voltage, High-level	$V_{(TO)2}$	$T_j = 125^\circ\text{C}, I = \pi I_{T(av)}$ to $I_{TSM}$			0.97621	Volts
Slope Resistance, High-level	$r_{T2}$				0.06881	m $\Omega$
$V_{TM}$ Coefficients, Low-level		$T_j = 125^\circ\text{C}, I = 15\% I_{T(av)}$ to $\pi I_{T(av)}$				
					$A_1 = -0.063144$	
					$B_1 = 0.14784$	
					$C_1 = 1.161\text{E-}04$	
					$D_1 = -0.009048$	
$V_{TM}$ Coefficients, High-level		$T_j = 125^\circ\text{C}, I = \pi I_{T(av)}$ to $I_{TSM}$				
					$A_2 = 9.5165$	
					$B_2 = -1.3858$	
					$C_2 = -2.9\text{E-}05$	
					$D_2 = 0.050907$	
Typical Delay Time	$t_d$	Switching from 140V, 20V, 10 $\Omega$ Gate, 0.5 $\mu\text{sec}$ Rise Time		8		$\mu\text{sec}$
Typical Turn-off Time	$t_q$	$T_j = 125^\circ\text{C}, I_T = 1000\text{A}, V_R > 50\text{V},$ Reapplied $dv/dt = 20\text{V}/\mu\text{sec}$ Linear to 80% $V_{DRM}$		400		$\mu\text{sec}$
Minimum Critical $dv/dt$ - Linear to $V_{DRM}$	$dv/dt$	$T_j = 125^\circ\text{C}, V_{DRM} = 80\%$ Rated Gate Open	300			V/ $\mu\text{sec}$
Gate Trigger Current	$I_{GT}$	$T_j = 25^\circ\text{C}, V_D = 12\text{V}$	30		250	mA
Gate Trigger Voltage	$V_{GT}$	$T_j = 25^\circ\text{C}, V_D = 12\text{V}$	0.5		4.0	Volts
Peak Reverse Gate Voltage	$V_{GRM}$				10	Volts
<b>Thermal Characteristics</b>						
Maximum Thermal Resistance, Double Sided Cooling						
Junction-to-Case	$R_{\theta(j-c)}$				0.010	$^\circ\text{C/W}$
Case-to-Sink	$R_{\theta(c-s)}$				0.002	$^\circ\text{C/W}$

Powerex, Inc., 200 Hillis Street, Youngwood, Pennsylvania 15697-1800 (412) 925-7272  
 Powerex, Europe, S.A. 428 Avenue G. Durand, BP107, 72003 Le Mans, France (43) 41.14.14

**TBS7 3500A**  
**Phase Control SCR**  
 3500 Amperes Average, 600 Volts

**Maximum On-State Forward Voltage Drop**  
 ( $T_J = 125^\circ\text{C}$ )

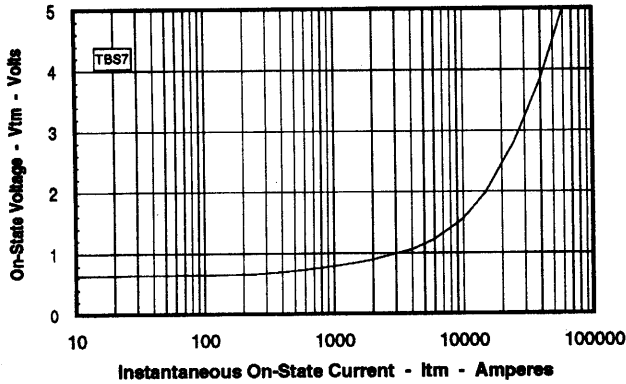

**Maximum Transient Thermal Impedance**  
 (Junction to Case)

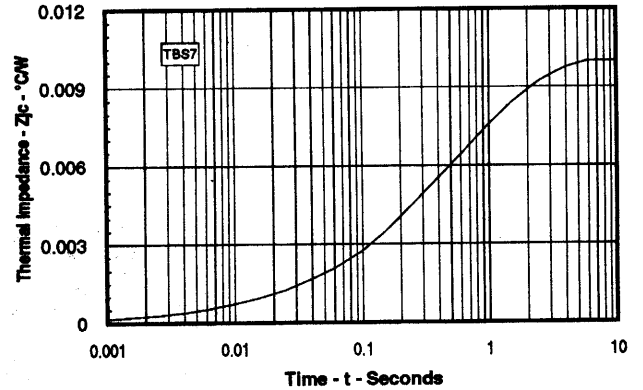

**Maximum On-State Power Dissipation**  
 (Sinusoidal Waveform)

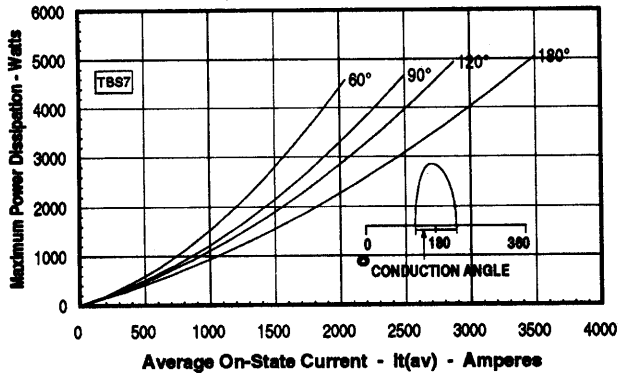

**Maximum Allowable Case Temperature**  
 (Sinusoidal Waveform)

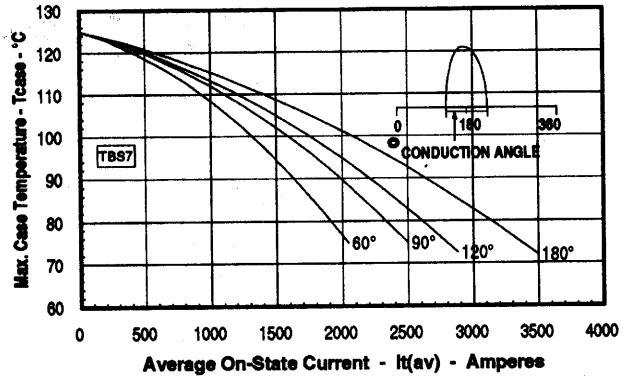

**Maximum On-State Power Dissipation**  
 (Rectangular Waveform)

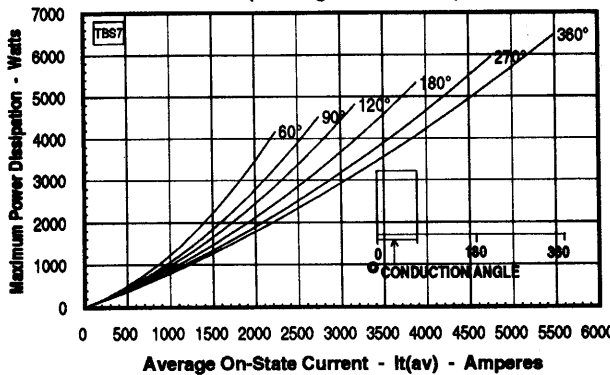

**Maximum Allowable Case Temperature**  
 (Rectangular Waveform)

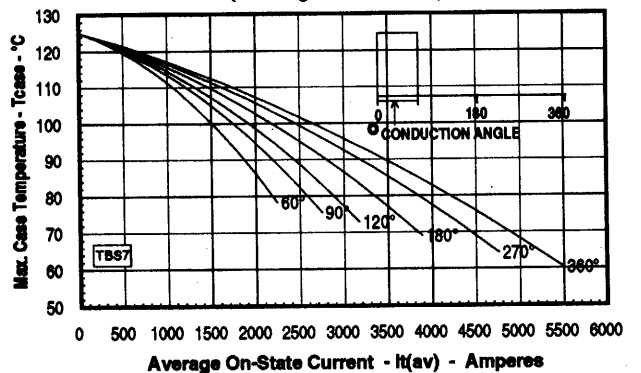

Note: Spreading losses included. Curves are for an inductive load.