

Powerex, Inc., 200 Hillis Street, Youngwood, Pennsylvania 15697-1800 (412) 925-7272
 Powerex, Europe, S.A. 428 Avenue G. Durand, BP107, 72003 Le Mans, France (43) 41.14.14

Phase Control SCR
 3000 Amperes Average
 600 Volts

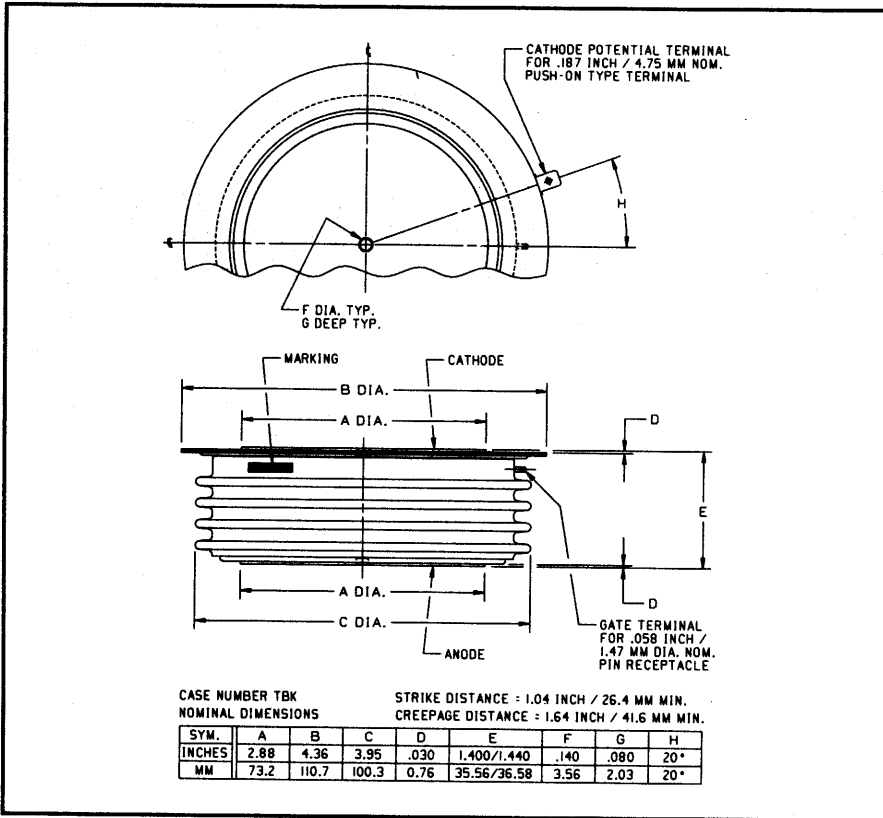

TBK7 3000A (Outline Drawing)

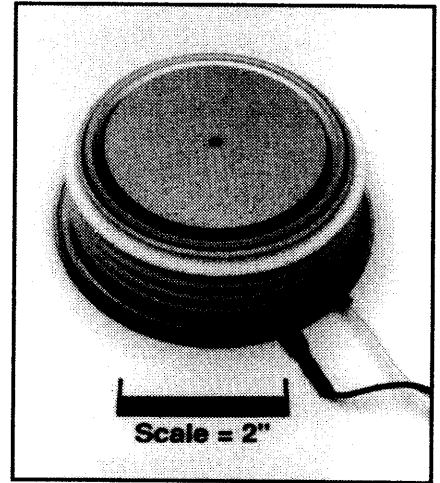

TBK7 3000A Phase Control SCR
 3000 Amperes Average, 600 Volts

Description:

The TBK7 is a low voltage, high current version of the Powerex C781. Powerex Silicon Controlled Rectifiers (SCR) are designed for phase control applications. These are all-diffused, Press-Pak, hermetic Pow-R-Disc devices employing the field proven amplifying gate.

Features:

- Low On-State Voltage
- High di/dt Capability
- High dv/dt Capability
- Hermetic Packaging
- Excellent Surge and I²t Ratings
- Also Available in Thin Package (26mm) as TBS7 for Higher Current Capability.

Ordering Information:

Select the complete 12 digit part number you desire from the table below.

Type	Voltage	Current	Turn-off	Gate Current	Lead Code
	V _{DRM} /V _{RRM} (Volts)	I _{T(av)} (A)	t _q (μsec)	I _{GT} (mA)	
TBK7	02 04 06 200V 400V 600V	30 3000A	0 400μsec (Typical)	H 250mA	HE 20"

Applications:

- Power Supplies
- Motor Control
- Battery Chargers



Powerex, Inc., 200 Hillis Street, Youngwood, Pennsylvania 15697-1800 (412) 925-7272
 Powerex, Europe, S.A. 428 Avenue G. Durand, BP107, 72003 Le Mans, France (43) 41.14.14

TBK7 3000A
Phase Control SCR
 3000 Amperes Average, 600 Volts

Absolute Maximum Ratings

Characteristics	Symbol	TBK7 3000A	Units
Non-repetitive Transient Peak Reverse Voltage	V_{RSM}	$V_{RRM} + 100V$	Volts
RMS On-state Current, $T_C = 70^\circ C$	$I_T(rms)$	4710	Amperes
Average Current 180° Sine Wave, $T_C = 70^\circ C$	$I_T(av)$	3000	Amperes
RMS On-state Current, $T_C = 55^\circ C$	$I_T(rms)$	5888	Amperes
Average Current 180° Sine Wave, $T_C = 55^\circ C$	$I_T(av)$	3750	Amperes
Peak One Cycle Surge On-state Current (Non-repetitive) 60Hz	I_{tsm}	48000	Amperes
Peak One Cycle Surge On-state Current (Non-repetitive) 50Hz	I_{tsm}	44200	Amperes
Critical Rate-of-rise of On-state Current (Non-repetitive)	di/dt	600	A/ μ sec
Critical Rate-of-rise of On-state Current (Repetitive)	di/dt	100	A/ μ sec
I^2t (for Fusing) for One Cycle, 60Hz	I^2t	9.6×10^6	A^2sec
Peak Gate Power Dissipation	P_{GM}	250	Watts
Average Gate Power Dissipation	$P_{G(av)}$	35	Watts
Operating Temperature	T_j	-40 to +125°C	°C
Storage Temperature	T_{stg}	-40 to +150°C	°C
Approximate Weight		3.5	lb.
		1.60	kg
Mounting Force		6000 to 10000	lb.
		26.6 to 44.4	kN



Powerex, Inc., 200 Hillis Street, Youngwood, Pennsylvania 15697-1800 (412) 925-7272
 Powerex, Europe, S.A. 428 Avenue G. Durand, BP107, 72003 Le Mans, France (43) 41.14.14

TBK7 3000A
Phase Control SCR
 3000 Amperes Average, 600 Volts

Electrical Characteristics, $T_j = 25^\circ\text{C}$ Unless Otherwise Specified

Characteristics	Symbol	Test Conditions	Min.	Typ.	Max.	Units
Repetitive Peak Reverse Leakage Current	I_{RRM}	$T_j = 125^\circ\text{C}, V_R = V_{RRM}$			150	mA
Repetitive Peak Forward Leakage Current	I_{DRM}	$T_j = 125^\circ\text{C}, V_D = V_{DRM}$			150	mA
Peak On-state Voltage	V_{TM}	$I_{TM} = 3000\text{A Peak}$ Duty Cycle < 0.01%			1.05	Volts
Threshold Voltage, Low-level	$V_{(TO)1}$	$T_j = 125^\circ\text{C}, I = 15\%, I_{T(av)} \text{ to } \pi I_{T(av)}$			0.6917	Volts
Slope Resistance, Low-level	r_{T1}				0.08747	m Ω
Threshold Voltage, High-level	$V_{(TO)2}$	$T_j = 125^\circ\text{C}, I = \pi I_{T(av)} \text{ to } I_{TSM}$			0.97621	Volts
Slope Resistance, High-level	r_{T2}				0.06881	m Ω
V_{TM} Coefficients, Low-level		$T_j = 125^\circ\text{C}, I = 15\% I_{T(av)} \text{ to } \pi I_{T(av)}$				$A_1 = -0.063144$ $B_1 = 0.14784$ $C_1 = 1.161\text{E-}04$ $D_1 = -0.009048$
V_{TM} Coefficients, High-level		$T_j = 125^\circ\text{C}, I = \pi I_{T(av)} \text{ to } I_{TSM}$				$A_2 = 9.5164$ $B_2 = -1.3858$ $C_2 = -2.9\text{E-}05$ $D_2 = 0.05091$
Typical Delay Time	t_d	Switching from 140V, 20V, 10 Ω Gate, 0.5 μsec Rise Time		8		μsec
Typical Turn-off Time	t_q	$T_j = 125^\circ\text{C}, I_T = 1000\text{A}, V_R > 50\text{V},$ Reapplied $dv/dt = 20\text{V}/\mu\text{sec}$ Linear to 80% V_{DRM}		400		μsec
Minimum Critical dv/dt - Linear to V_{DRM}	dv/dt	$T_j = 125^\circ\text{C}, V_{DRM} = 80\% \text{ Rated}$ Gate Open	300			V/ μsec
Gate Trigger Current	I_{GT}	$T_j = 25^\circ\text{C}, V_D = 12\text{V}$	30		250	mA
Gate Trigger Voltage	V_{GT}	$T_j = 25^\circ\text{C}, V_D = 12\text{V}$	0.5		4.0	Volts
Peak Reverse Gate Voltage	V_{GRM}				10	Volts

Thermal Characteristics

Maximum Thermal Resistance, Double Sided Cooling

Junction-to-Case	$R_{\theta(j-c)}$		0.012	$^\circ\text{C/W}$
Case-to-Sink	$R_{\theta(c-s)}$		0.002	$^\circ\text{C/W}$

Powerex, Inc., 200 Hillis Street, Youngwood, Pennsylvania 15697-1800 (412) 925-7272
 Powerex, Europe, S.A. 428 Avenue G. Durand, BP107, 72003 Le Mans, France (43) 41.14.14

TBK7 3000A
Phase Control SCR
 3000 Amperes Average, 600 Volts

Maximum On-State Forward Voltage Drop
 ($T_j = 125^\circ\text{C}$)

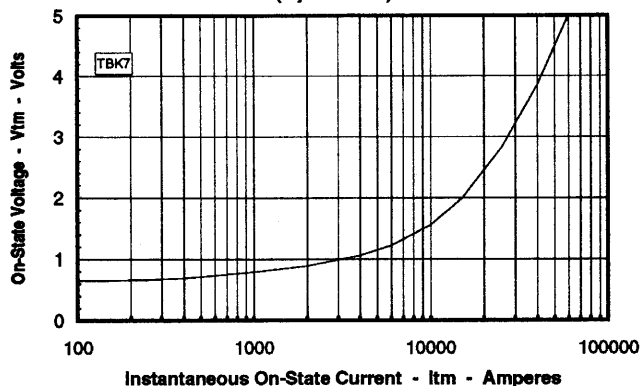

Maximum Transient Thermal Impedance
 (Junction to Case)

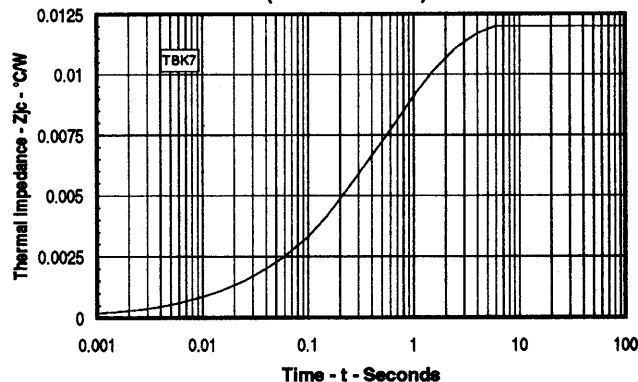

Maximum On-State Power Dissipation
 (Sinusoidal Waveform)

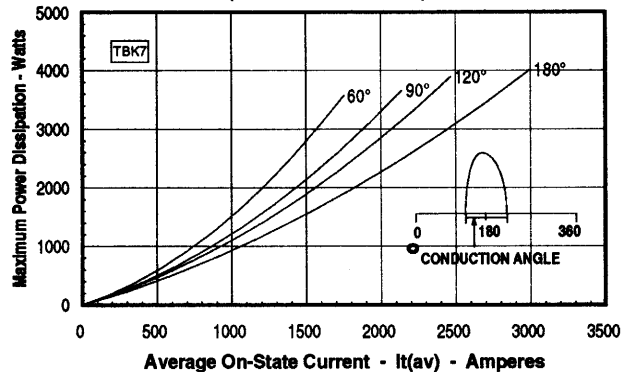

Maximum Allowable Case Temperature
 (Sinusoidal Waveform)

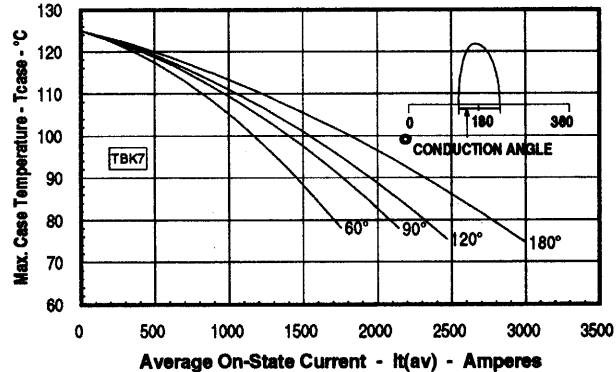

Maximum On-State Power Dissipation
 (Rectangular Waveform)

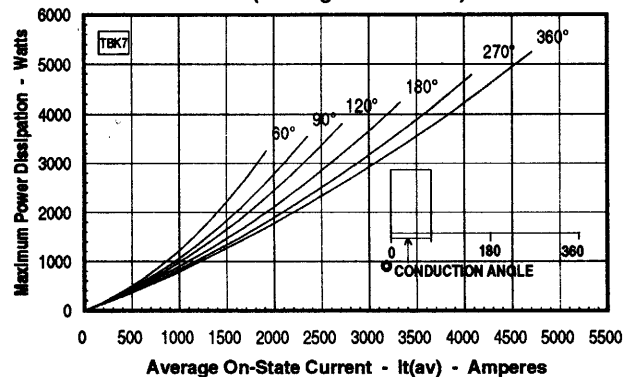

Maximum Allowable Case Temperature
 (Rectangular Waveform)

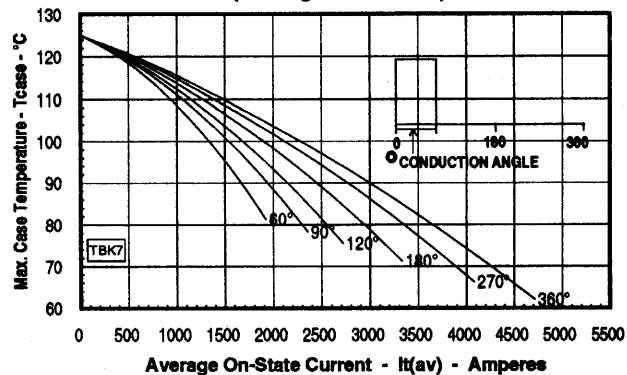

Note: Spreading losses included. Curves are for an inductive load.