

Powerex, Inc., 200 Hillis Street, Youngwood, Pennsylvania 15697-1800 (412) 925-7272
 Powerex, Europe, S.A. 428 Avenue G. Durand, BP107, 72003 Le Mans, France (43) 41.14.14

Phase Control SCR
 800 Amperes Average
 4500 Volts

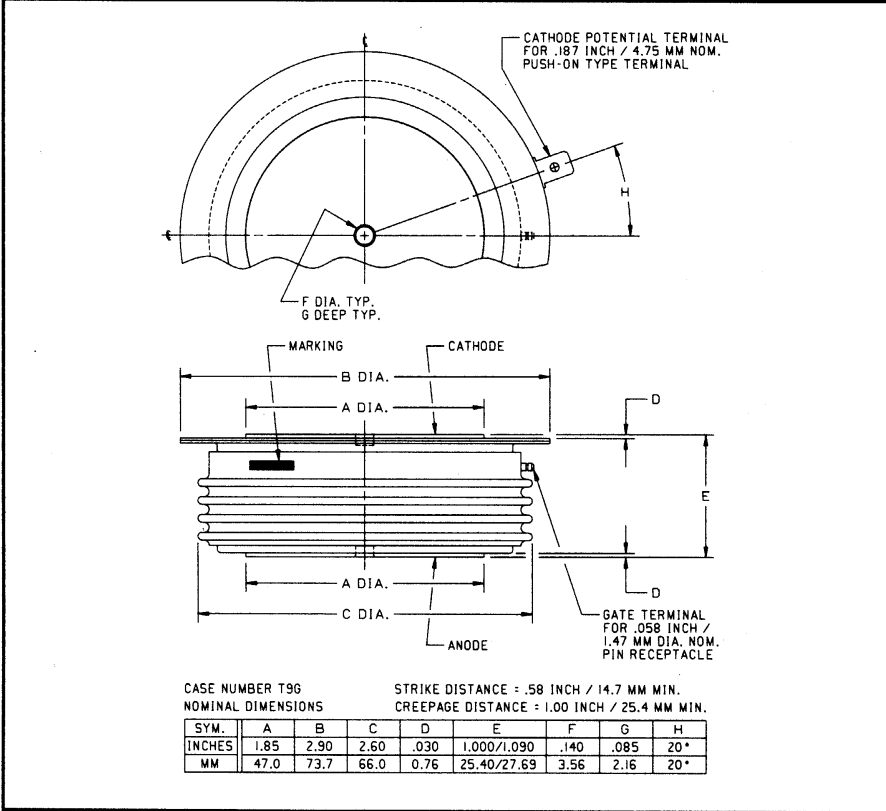

T9K7 800A (Outline Drawing)

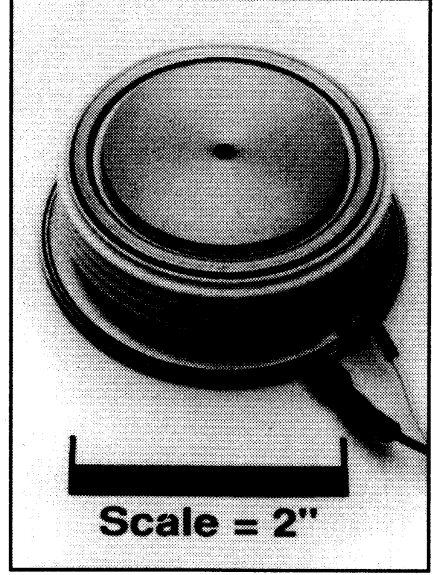

T9K7 800A Phase Control SCR
 800 Amperes Average, 4500 Volts

Description:

The T9K7 is a high voltage version of the Powerex C702. Powerex Silicon Controlled Rectifiers (SCR) are designed for phase control applications. These are all-dif-fused, Press-Pak, hermetic Pow-R-Disc devices employing the field proven amplifying gate.

Features:

- Low On-State Voltage
- High dv/dt Capability
- Hermetic Packaging
- Excellent Surge and I^2t Ratings

Applications:

- Power Supplies
- Motor Starters
- Motor Control
- VAR Generators

Ordering Information:

Select the complete 12 digit part number you desire from the table below.

Type	Voltage	Current	Turn-off	Gate Current	Lead Code
	V_{DRM}/V_{RRM} (Volts)	$I_T(av)$ (A)	t_q (μ sec)	I_{GT} (mA)	
T9K7	36 40 42 45	08	0	2	DH
	3600V 4000V 4200V 4500V	800A	500 μ sec (Typical)	300mA	12"



Powerex, Inc., 200 Hillis Street, Youngwood, Pennsylvania 15697-1800 (412) 925-7272
 Powerex, Europe, S.A. 428 Avenue G. Durand, BP107, 72003 Le Mans, France (43) 41.14.14

T9K7 800A
Phase Control SCR
 800 Amperes Average, 4500 Volts

Absolute Maximum Ratings

Characteristics	Symbol	T9K7 800A	Units
Non-repetitive Transient Peak Reverse Voltage	V_{RSM}	$V_{RRM} + 100V$	Volts
RMS On-state Current, $T_C = 79^\circ C$	$I_{T(rms)}$	1250	Amperes
Average Current 180° Sine Wave, $T_C = 79^\circ C$	$I_{T(av)}$	800	Amperes
RMS On-state Current, $T_C = 55^\circ C$	$I_{T(rms)}$	1665	Amperes
Average Current 180° Sine Wave, $T_C = 55^\circ C$	$I_{T(av)}$	1060	Amperes
Peak One Cycle Surge On-state Current (Non-repetitive) 60Hz	I_{tsm}	9000	Amperes
Peak One Cycle Surge On-state Current (Non-repetitive) 50Hz	I_{tsm}	8000	Amperes
Critical Rate-of-rise of On-state Current (Non-repetitive)	di/dt	200	A/ μ sec
Critical Rate-of-rise of On-state Current (Repetitive)	di/dt	75	A/ μ sec
I^2t (for Fusing) for One Cycle, 60Hz	I^2t	337,500	A ² sec
Peak Gate Power Dissipation	P_{GM}	200	Watts
Average Gate Power Dissipation	$P_{G(av)}$	5	Watts
Operating Temperature	T_j	-40 to +125°C	°C
Storage Temperature	T_{stg}	-40 to +150°C	°C
Approximate Weight		1	lb.
		454	g
Mounting Force		5000 to 6000	lb.
		22.2 to 26.6	kg.



Powerex, Inc., 200 Hillis Street, Youngwood, Pennsylvania 15697-1800 (412) 925-7272
 Powerex, Europe, S.A. 428 Avenue G. Durand, BP107, 72003 Le Mans, France (43) 41.14.14

T9K7 800A
Phase Control SCR
 800 Amperes Average, 4500 Volts

Electrical Characteristics, $T_j = 25^\circ\text{C}$ Unless Otherwise Specified

Characteristics	Symbol	Test Conditions	Min.	Typ.	Max.	Units
Repetitive Peak Reverse Leakage Current	I_{RRM}	$T_j = 125^\circ\text{C}, V_R = V_{RRM}$			150	mA
Repetitive Peak Forward Leakage Current	I_{DRM}	$T_j = 125^\circ\text{C}, V_D = V_{DRM}$			150	mA
Peak On-state Voltage	V_{TM}	$I_{TM} = 1500\text{A Peak}$ Duty Cycle < 0.1%			2.0	Volts
Threshold Voltage, Low-level	$V_{(TO)1}$	$T_j = 125^\circ\text{C}, I = 15\%, I_{T(av)}$ to $\pi I_{T(av)}$			1.2127	Volts
Slope Resistance, Low-level	r_{T1}				0.6021	$m\Omega$
Threshold Voltage, High-level	$V_{(TO)2}$	$T_j = 125^\circ\text{C}, I = \pi I_{T(av)}$ to I_{TSM}			1.3048	Volts
Slope Resistance, High-level	r_{T2}				0.5897	$m\Omega$
V_{TM} Coefficients, Low-level		$T_j = 125^\circ\text{C}, I = 15\% I_{T(av)}$ to $\pi I_{T(av)}$				
					$A_1 = 1.9623$	
					$B_1 = -0.19517$	
					$C_1 = 4.845E-04$	
					$D_1 = 0.021894$	
V_{TM} Coefficients, High-level		$T_j = 125^\circ\text{C}, I = \pi I_{T(av)}$ to I_{TSM}				
					$A_2 = -19.918$	
					$B_2 = 3.7822$	
					$C_2 = 0.001228$	
					$D_2 = -0.20013$	
Typical Delay Time	t_d	$V_D = 0.5V_{DRM}$		3.0		μsec
Typical Turn-off Time	t_q	$V_R = 100\text{V},$ $di_R/dt = 5\text{A}/\mu\text{sec}$ Reapplied $dv/dt = 20\text{V}/\mu\text{sec}$. Linear to 50% V_{DRM}		500		μsec
Minimum Critical dv/dt - Exponential to V_D	dv/dt	$T_j = 125^\circ\text{C}, V_D = 0.8V_{DRM}$	800			$\text{V}/\mu\text{sec}$
Gate Trigger Current	I_{GT}	$T_j = 25^\circ\text{C}, V_D = 12\text{V}$	30		300	mA
Gate Trigger Voltage	V_{GT}	$T_j = 25^\circ\text{C}, V_D = 12\text{V}$	0.5		4.5	Volts
Peak Reverse Gate Voltage	V_{GRM}				5	Volts

Thermal Characteristics

Maximum Thermal Resistance, Double Sided Cooling

Junction-to-Case	$R_{\theta(j-c)}$		0.023	$^\circ\text{C}/\text{W}$
Case-to-Sink	$R_{\theta(c-s)}$		0.0075	$^\circ\text{C}/\text{W}$

Powerex, Inc., 200 Hillis Street, Youngwood, Pennsylvania 15697-1800 (412) 925-7272
 Powerex, Europe, S.A. 428 Avenue G. Durand, BP107, 72003 Le Mans, France (43) 41.14.14

T9K7 800A
Phase Control SCR
 800 Amperes Average, 4500 Volts

Maximum On-State Forward Voltage Drop
 ($T_J = 125^\circ\text{C}$)

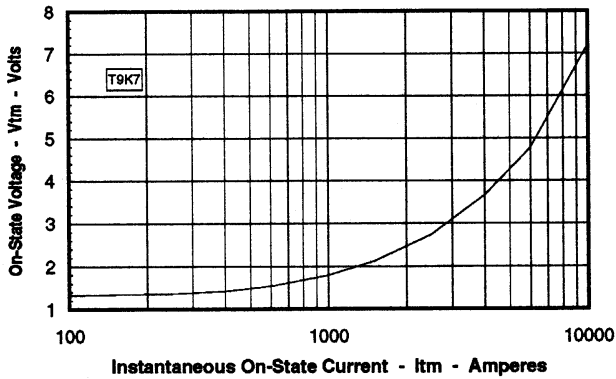

Maximum Transient Thermal Impedance
 (Junction to Case)

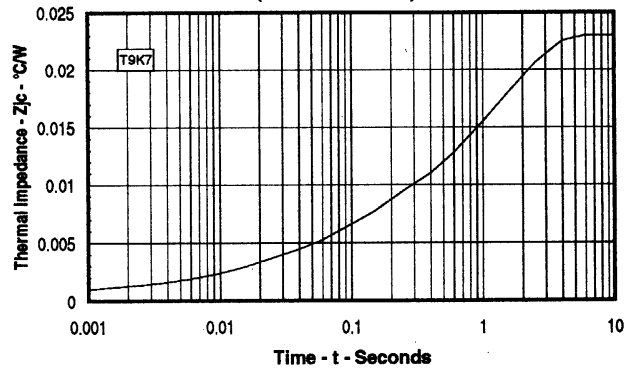

Maximum On-State Power Dissipation
 (Sinusoidal Waveform)

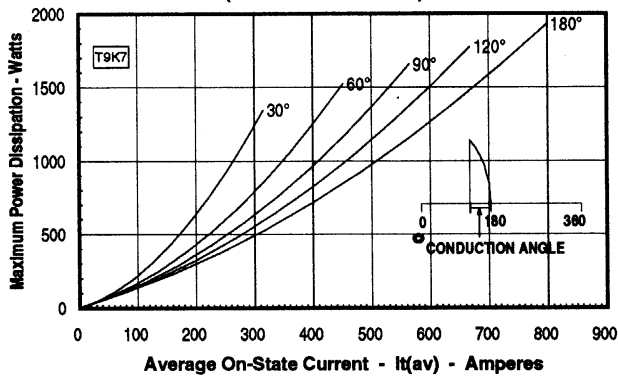

Maximum Allowable Case Temperature
 (Sinusoidal Waveform)

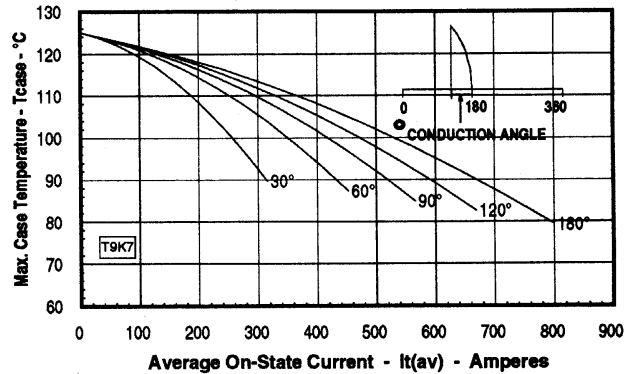

Maximum On-State Power Dissipation
 (Rectangular Waveform)

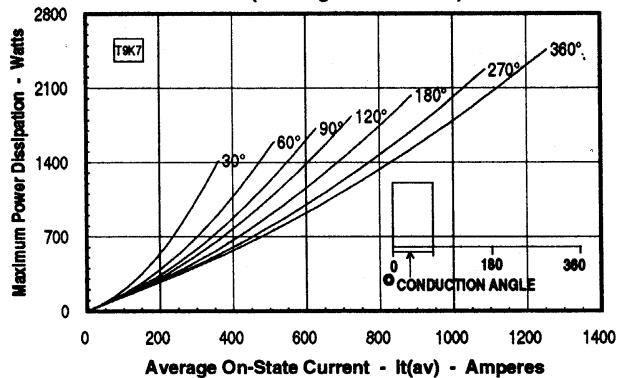

Maximum Allowable Case Temperature
 (Rectangular Waveform)

