

Powerex, Inc., 200 Hillis Street, Youngwood, Pennsylvania 15697-1800 (412) 925-7272  
 Powerex, Europe, S.A. 428 Avenue G. Durand, BP107, 72003 Le Mans, France (43) 41.14.14

### Phase Control SCR

1200 Amperes Average  
 2400 Volts

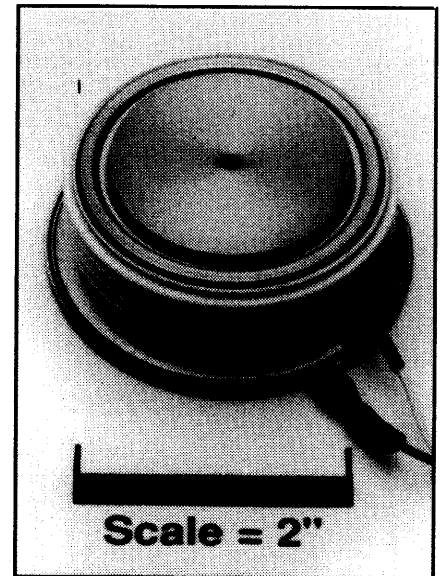
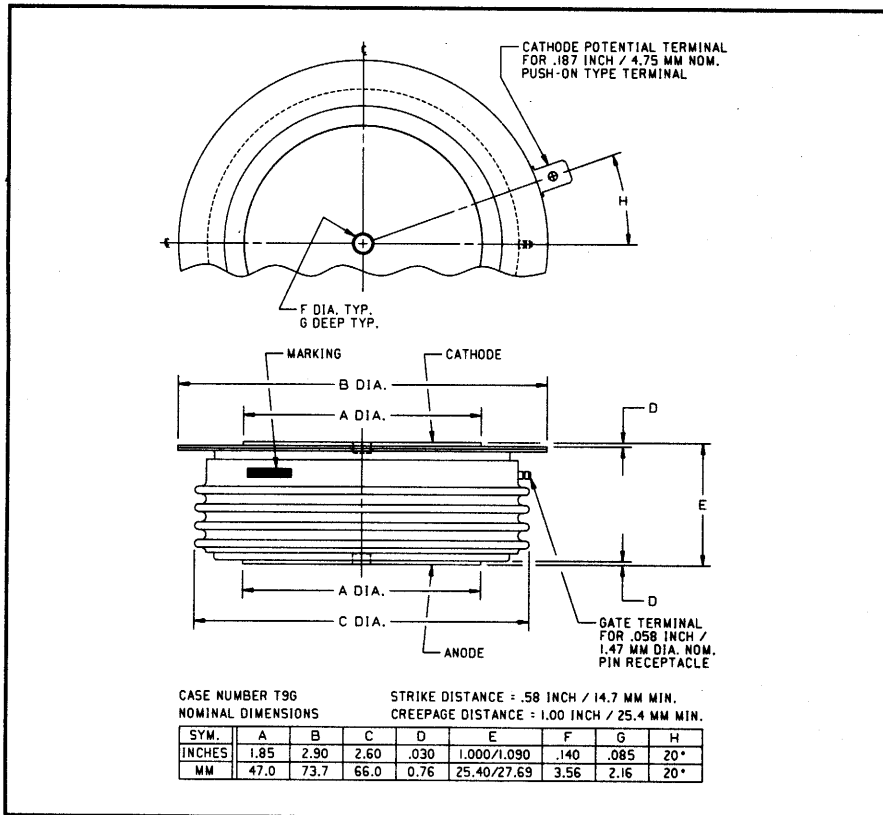

T9G0 1200A Phase Control SCR  
 1200 Amperes Average, 2400 Volts

T9G0 1200A (Outline Drawing)

### Description:

Powerex Silicon Controlled Rectifiers (SCR) are designed for phase control applications. These are all-diffused, Press-Pak, hermetic Pow-R-Disc devices employing the field proven amplifying gate.

### Features:

- Low On-State Voltage
- High di/dt Capability
- High dv/dt Capability
- Hermetic Packaging
- Excellent Surge and I<sup>2</sup>t Ratings

### Applications:

- Power Supplies
- Motor Control

### Ordering Information:

Select the complete 12 digit part number you desire from the table below.

Type	Voltage	Current	Turn-off	Gate Current	Lead Code
	V <sub>DRM</sub> /V <sub>RRM</sub> (Volts)	I <sub>T(av)</sub> (A)	t <sub>q</sub> (μsec)	I <sub>GT</sub> (mA)	
T9G0	02 through 24  200V through 2400V	12  1200A	0  350μsec (Typical)	3  200mA	DH  12"



Powerex, Inc., 200 Hillis Street, Youngwood, Pennsylvania 15697-1800 (412) 925-7272  
Powerex, Europe, S.A. 428 Avenue G. Durand, BP107, 72003 Le Mans, France (43) 41.14.14

**T9G0 1200A**  
**Phase Control SCR**  
1200 Amperes Average, 2400 Volts

### Absolute Maximum Ratings

Characteristics	Symbol	T9G0 1200A	Units
Non-repetitive Transient Peak Reverse Voltage	$V_{RSM}$	$V_{RRM} + 100V$	Volts
RMS On-state Current, $T_C = 85^\circ C$	$I_T(rms)$	1880	Amperes
Average Current 180° Sine Wave, $T_C = 85^\circ C$	$I_T(av)$	1200	Amperes
RMS On-state Current, $T_C = 55^\circ C$	$I_T(rms)$	2790	Amperes
Average Current 180° Sine Wave, $T_C = 55^\circ C$	$I_T(av)$	1780	Amperes
Peak One Cycle Surge On-state Current (Non-repetitive) 60Hz	$I_{tsm}$	27000	Amperes
Peak One Cycle Surge On-state Current (Non-repetitive) 50Hz	$I_{tsm}$	24650	Amperes
Critical Rate-of-rise of On-state Current (Non-repetitive)	$di/dt$	300	A/ $\mu$ sec
Critical Rate-of-rise of On-state Current (Repetitive)	$di/dt$	150	A/ $\mu$ sec
$I^2t$ (for Fusing) for One Cycle, 60Hz	$I^2t$	3,040,000	A <sup>2</sup> sec
Peak Gate Power Dissipation	$P_{GM}$	16	Watts
Average Gate Power Dissipation	$P_{G(av)}$	3	Watts
Operating Temperature	$T_j$	-40 to +125°C	°C
Storage Temperature	$T_{stg}$	-40 to +150°C	°C
Approximate Weight		1	lb.
		454	g
Mounting Force		5000 to 5500	lb.
		2270 to 2500	kg.



Powerex, Inc., 200 Hillis Street, Youngwood, Pennsylvania 15697-1800 (412) 925-7272  
 Powerex, Europe, S.A. 428 Avenue G. Durand, BP107, 72003 Le Mans, France (43) 41.14.14

**T9G0 1200A**  
**Phase Control SCR**  
 1200 Amperes Average, 2400 Volts

**Electrical Characteristics,  $T_j = 25^\circ\text{C}$  Unless Otherwise Specified**

Characteristics	Symbol	Test Conditions	Min.	Typ.	Max.	Units
Repetitive Peak Reverse Leakage Current	$I_{RRM}$	$T_j = 125^\circ\text{C}, V_R = V_{RRM}$			75	mA
Repetitive Peak Forward Leakage Current	$I_{DRM}$	$T_j = 125^\circ\text{C}, V_D = V_{DRM}$			75	mA
Peak On-state Voltage	$V_{TM}$	$I_{TM} = 1500\text{A Peak}$ Duty Cycle < 0.1%			1.35	Volts
Threshold Voltage, Low-level	$V_{(TO)1}$	$T_j = 125^\circ\text{C}, I = 15\%, I_{T(av)}$ to $\pi I_{T(av)}$			0.60559	Volts
Slope Resistance, Low-level	$r_{T1}$				0.2681	m $\Omega$
Threshold Voltage, High-level	$V_{(TO)2}$	$T_j = 125^\circ\text{C}, I = \pi I_{T(av)}$ to $I_{TSM}$			0.64284	Volts
Slope Resistance, High-level	$r_{T2}$				0.1906	m $\Omega$
$V_{TM}$ Coefficients, Low-level		$T_j = 125^\circ\text{C}, I = 15\% I_{T(av)}$ to $\pi I_{T(av)}$			$A_1 = -0.55126$ $B_1 = 0.21303$ $C_1 = 1.433\text{E-}04$ $D_1 = -0.003097$	
$V_{TM}$ Coefficients, High-level		$T_j = 125^\circ\text{C}, I = \pi I_{T(av)}$ to $I_{TSM}$			$A_1 = -62.5287$ $B_1 = 10.457$ $C_1 = 0.001238$ $D_1 = -0.43650$	
Typical Turn-on Time	$t_{on}$	$I_{TM} = 1000\text{A}, V_D = 450\text{V}$		3		$\mu\text{sec}$
Typical Turn-off Time	$t_q$	$T_j = 125^\circ\text{C}, I_T = 250\text{A},$ $di_R/dt = 50\text{A}/\mu\text{sec}$ Reapplied $dv/dt = 20\text{V}/\mu\text{sec}$ Linear to 80% $V_{DRM}$		350		$\mu\text{sec}$
Minimum Critical $dv/dt$ - Exponential to $V_{DRN=M}$	$dv/dt$	$T_j = 125^\circ\text{C}$	300			V/ $\mu\text{sec}$
Gate Trigger Current	$I_{GT}$	$T_j = 25^\circ\text{C}, V_D = 12\text{V}$			200	mA
Gate Trigger Voltage	$V_{GT}$	$T_j = 25^\circ\text{C}, V_D = 12\text{V}$			3.0	Volts
Non-Trigging Gate Voltage	$V_{GDM}$	$T_j = 125^\circ\text{C}, V_D = V_{DRM}$			0.15	Volts
Peak Forward Gate Current	$I_{GTM}$				4	A
Peak Reverse Gate Voltage	$V_{GRM}$				5	Volts

**Thermal Characteristics**

Maximum Thermal Resistance, Double Sided Cooling

Junction-to-Case	$R_{\theta(j-c)}$		0.023	$^\circ\text{C}/\text{W}$
Case-to-Sink	$R_{\theta(c-s)}$		0.0075	$^\circ\text{C}/\text{W}$

Powerex, Inc., 200 Hillis Street, Youngwood, Pennsylvania 15697-1800 (412) 925-7272  
 Powerex, Europe, S.A. 428 Avenue G. Durand, BP107, 72003 Le Mans, France (43) 41.14.14

**T9G0 1200A**  
**Phase Control SCR**  
 1200 Amperes Average, 2400 Volts

**Maximum On-State Forward Voltage Drop**  
 ( $T_J = 125^\circ\text{C}$ )

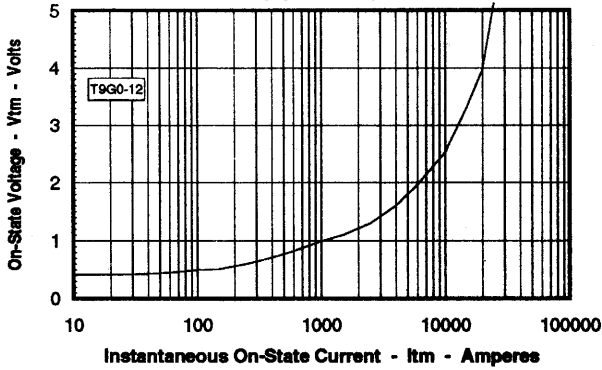

**Maximum Transient Thermal Impedance**  
 (Junction to Case)

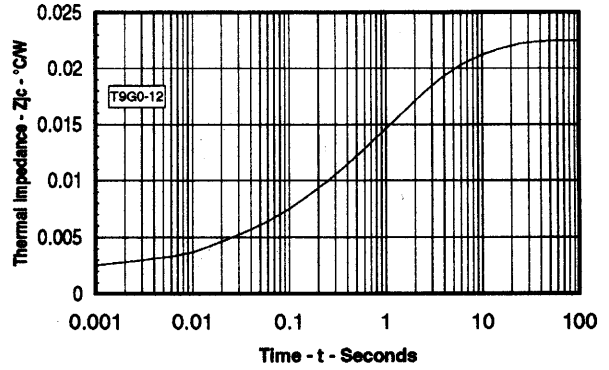

**Maximum On-State Power Dissipation**  
 (Sinusoidal Waveform)

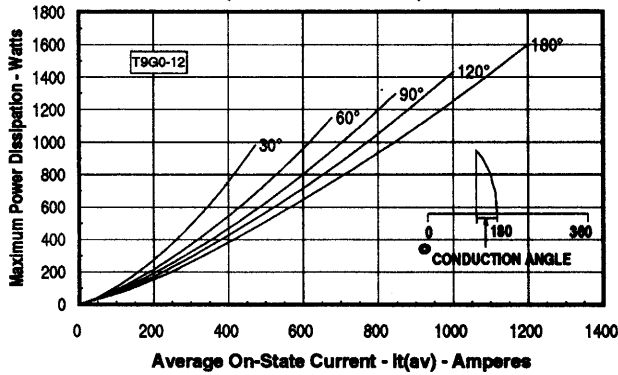

**Maximum Allowable Case Temperature**  
 (Sinusoidal Waveform)

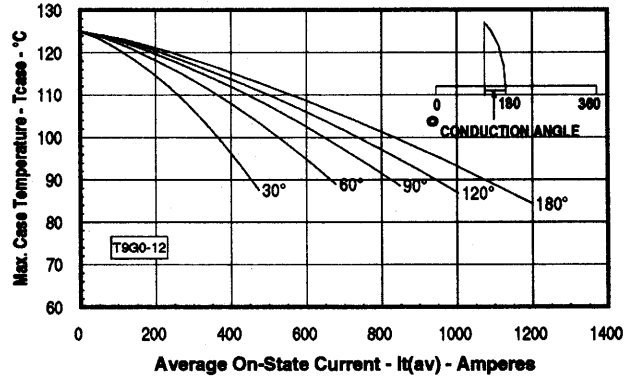

**Maximum On-State Power Dissipation**  
 (Rectangular Waveform)

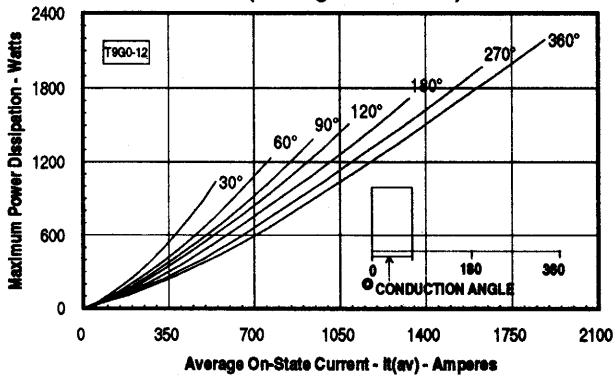

**Maximum Allowable Case Temperature**  
 (Rectangular Waveform)

