

Powerex, Inc., 200 Hillis Street, Youngwood, Pennsylvania 15697-1800 (412) 925-7272  
Powerex, Europe, S.A. 428 Avenue G. Durand, BP107, 72003 Le Mans, France (43) 41.14.14

**Phase Control SCR**  
750 Amperes Average  
1800-2400 Volts

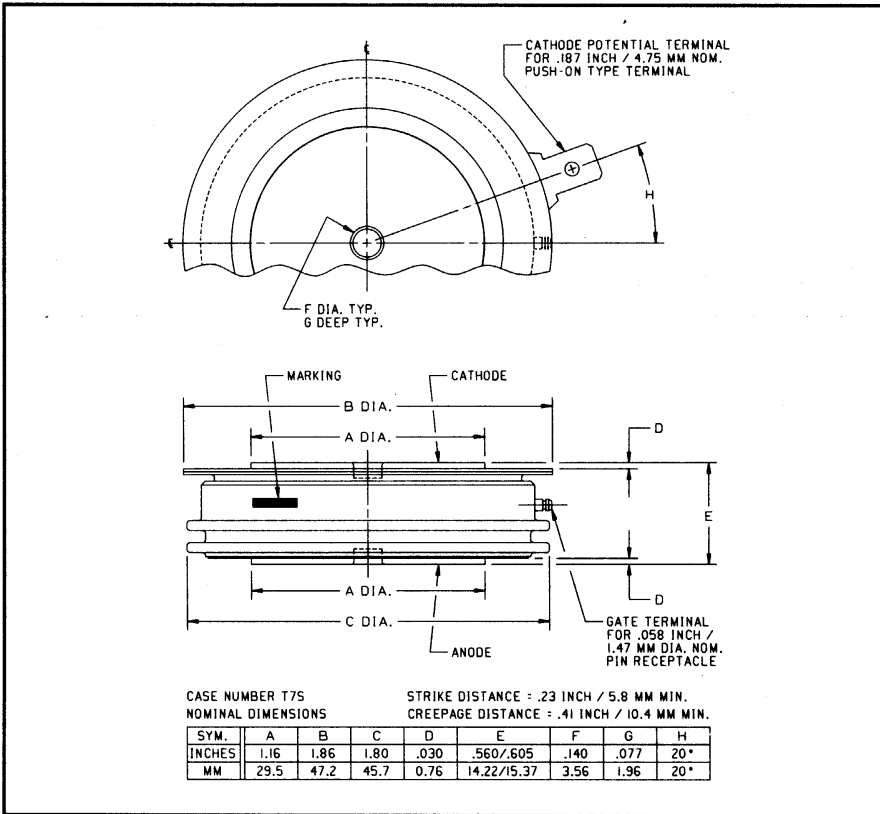

T7S0 750A (2400V) (Outline Drawing)

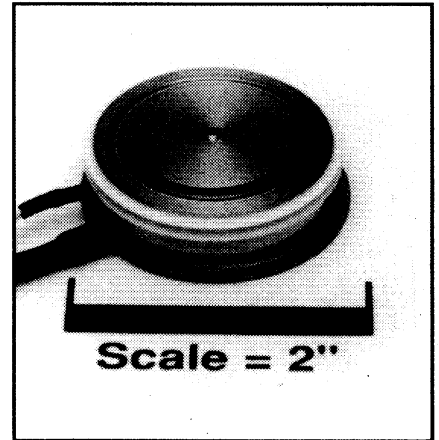

T7S0 750A (2400V) Phase Control SCR  
750 Amperes Average, 1800-2400 Volts

### Ordering Information:

Select the complete 12 digit part number you desire from the table below.

Type	Voltage	Current	Turn-off	Gate Current	Lead Code
	$V_{DRM}/V_{RRM}$ (Volts)	$I_{T(av)}$ (A)	$t_q$ ( $\mu$ sec)	$I_{GT}$ (mA)	
T7S0	18 20 24	75	0	4	DN
	1800V 2000V 2400V	750A	150 $\mu$ sec (Typical)	150mA	8"

### Description:

Powerex Silicon Controlled Rectifiers (SCR) are designed for phase control applications. These are all-diffused, Press-Pak, hermetic Pow-R-Disc devices employing the field proven amplifying gate.

### Features:

- Low On-State Voltage
- High di/dt Capability
- High dv/dt Capability
- Hermetic Packaging
- Excellent Surge and  $i^2t$  Ratings

### Applications:

- Power Supplies
- Motor Control



Powerex, Inc., 200 Hillis Street, Youngwood, Pennsylvania 15697-1800 (412) 925-7272  
Powerex, Europe, S.A. 428 Avenue G. Durand, BP107, 72003 Le Mans, France (43) 41.14.14

**T7S0 750A (2400V)**  
**Phase Control SCR**  
750 Amperes Average, 1800-2400 Volts

### Absolute Maximum Ratings

Characteristics	Symbol	T7S0 750A (2400V)	Units
Non-repetitive Transient Peak Reverse Voltage	$V_{RSM}$	$V_{RRM} + 100V$	Volts
RMS On-state Current, $T_C = 73^\circ C$	$I_{T(rms)}$	1180	Amperes
Average Current 180° Sine Wave, $T_C = 73^\circ C$	$I_{T(av)}$	750	Amperes
RMS On-state Current, $T_C = 55^\circ C$	$I_{T(rms)}$	1440	Amperes
Average Current 180° Sine Wave, $T_C = 55^\circ C$	$I_{T(av)}$	920	Amperes
Peak One Cycle Surge On-state Current (Non-repetitive) 60Hz	$I_{tsm}$	10500	Amperes
Peak One Cycle Surge On-state Current (Non-repetitive) 50Hz	$I_{tsm}$	9600	Amperes
Critical Rate-of-rise of On-state Current (Non-repetitive)	$di/dt$	600	A/ $\mu$ sec
Critical Rate-of-rise of On-state Current (Repetitive)	$di/dt$	150	A/ $\mu$ sec
$I^2t$ (for Fusing) for One Cycle, 60Hz	$I^2t$	460,000	A <sup>2</sup> sec
Peak Gate Power Dissipation	$P_{GM}$	16	Watts
Average Gate Power Dissipation	$P_{G(av)}$	3	Watts
Operating Temperature	$T_j$	-40 to +125°C	°C
Storage Temperature	$T_{stg}$	-40 to +150°C	°C
Approximate Weight		4	oz.
		113	g
Mounting Force		2000 to 2400	lb.
		900 to 1090	kg.



Powerex, Inc., 200 Hillis Street, Youngwood, Pennsylvania 15697-1800 (412) 925-7272  
 Powerex, Europe, S.A. 428 Avenue G. Durand, BP107, 72003 Le Mans, France (43) 41.14.14

T7S0 750A (2400V)  
 Phase Control SCR  
 750 Amperes Average, 1800-2400 Volts

### Electrical Characteristics, $T_j = 25^\circ\text{C}$ Unless Otherwise Specified

Characteristics	Symbol	Test Conditions	Min.	Typ.	Max.	Units
Repetitive Peak Reverse Leakage Current	$I_{RRM}$	$T_j = 125^\circ\text{C}$ , $V_R = V_{RRM}$			30	mA
Repetitive Peak Forward Leakage Current	$I_{DRM}$	$T_j = 125^\circ\text{C}$ , $V_D = V_{DRM}$			30	mA
Peak On-state Voltage	$V_{TM}$	$I_{TM} = 625\text{A Peak}$ Duty Cycle < 0.1%			1.40	Volts
Threshold Voltage, Low-level	$V_{(TO)1}$	$T_j = 125^\circ\text{C}$ , $I = 15\%$ , $I_{T(av)}$ to $\pi I_{T(av)}$			0.97192	Volts
Slope Resistance, Low-level	$r_{T1}$				0.4818	m $\Omega$
Threshold Voltage, High-level	$V_{(TO)2}$	$T_j = 125^\circ\text{C}$ , $I = \pi I_{T(av)}$ to $I_{TSM}$			1.4824	Volts
Slope Resistance, High-level	$r_{T2}$				0.2845	m $\Omega$
$V_{TM}$ Coefficients, Low-level		$T_j = 125^\circ\text{C}$ , $I = 15\% I_{T(av)}$ to $\pi I_{T(av)}$				$A_1 = 0.38516$ $B_1 = 0.12628$ $C_1 = 4.189\text{E-}04$ $D_1 = -0.005704$
$V_{TM}$ Coefficients, High-level		$T_j = 125^\circ\text{C}$ , $I = \pi I_{T(av)}$ to $I_{TSM}$				$A_2 = 2.1990$ $B_2 = -0.30712$ $C_2 = 4.831\text{E-}05$ $D_2 = 0.044366$
Typical Turn-on Time	$t_{on}$	$I_T = 100\text{A}$ , $V_D = 100\text{V}$		7		$\mu\text{sec}$
Typical Turn-off Time	$t_q$	$T_j = 125^\circ\text{C}$ , $I_T = 250\text{A}$ , $di_R/dt = 25\text{A}/\mu\text{sec}$ Reapplied $dv/dt = 20\text{V}/\mu\text{sec}$ Linear to 80% $V_{DRM}$		150		$\mu\text{sec}$
Minimum Critical $dv/dt$ - Exponential to $V_{DRM}$	$dv/dt$	$T_j = 125^\circ\text{C}$	300			$\text{V}/\mu\text{sec}$
Gate Trigger Current	$I_{GT}$	$T_j = 25^\circ\text{C}$ , $V_D = 12\text{V}$			150	mA
Gate Trigger Voltage	$V_{GT}$	$T_j = 25^\circ\text{C}$ , $V_D = 12\text{V}$			3.0	Volts
Non-Triggering Gate Voltage	$V_{GDM}$	$T_j = 125^\circ\text{C}$ , $V_D = V_{DRM}$			0.15	Volts
Peak Forward Gate Current	$I_{GTM}$				4	A
Peak Reverse Gate Voltage	$V_{GRM}$				5	Volts

### Thermal Characteristics

Maximum Thermal Resistance, Double Sided Cooling

Junction-to-Case	$R_{\theta(j-c)}$	0.035	$^\circ\text{C}/\text{W}$
Case-to-Sink	$R_{\theta(c-s)}$	0.02	$^\circ\text{C}/\text{W}$

Powerex, Inc., 200 Hillis Street, Youngwood, Pennsylvania 15697-1800 (412) 925-7272  
 Powerex, Europe, S.A. 428 Avenue G. Durand, BP107, 72003 Le Mans, France (43) 41.14.14

**T750 750A (2400V)**  
**Phase Control SCR**  
 750 Amperes Average, 1800-2400 Volts

**Maximum On-State Forward Voltage Drop**  
 (T<sub>J</sub> = 125 °C)

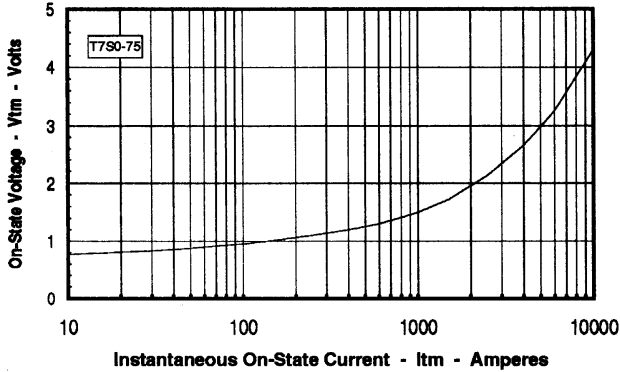

**Maximum Transient Thermal Impedance**  
 (Junction to Case)

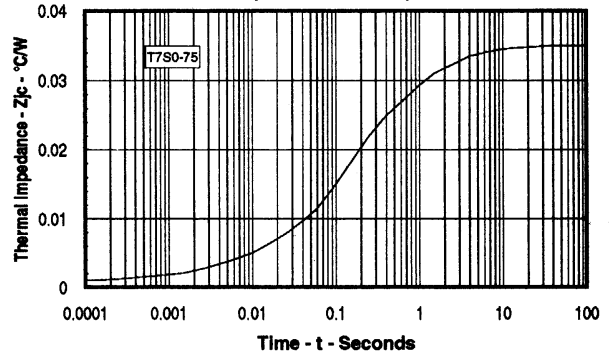

**Maximum On-State Power Dissipation**  
 (Sinusoidal Waveform)

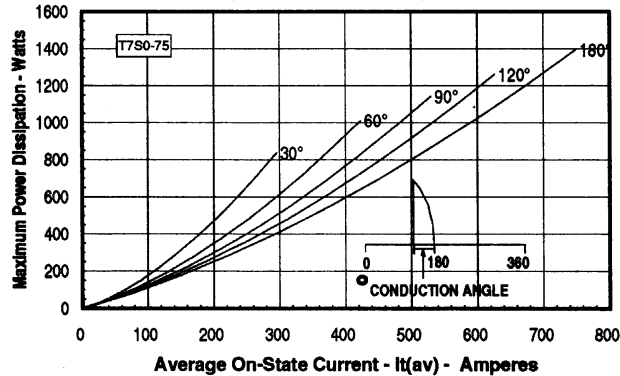

**Maximum Allowable Case Temperature**  
 (Sinusoidal Waveform)

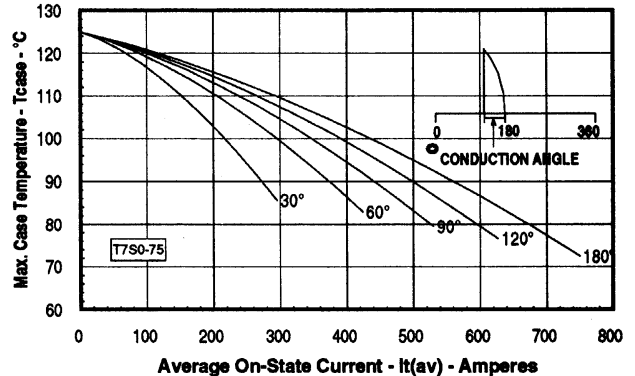

**Maximum On-State Power Dissipation**  
 (Rectangular Waveform)

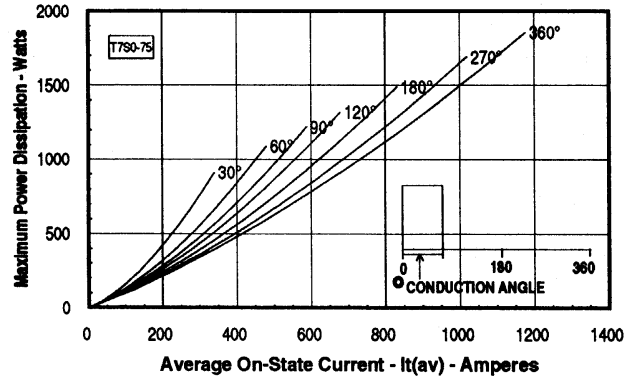

**Maximum Allowable Case Temperature**  
 (Rectangular Waveform)

