

Powerex, Inc., 200 Hillis Street, Youngwood, Pennsylvania 15697-1800 (412) 925-7272
Powerex, Europe, S.A. 428 Avenue G. Durand, BP107, 72003 Le Mans, France (43) 41.14.14

Phase Control SCR
750 Amperes Average
1800-2400 Volts

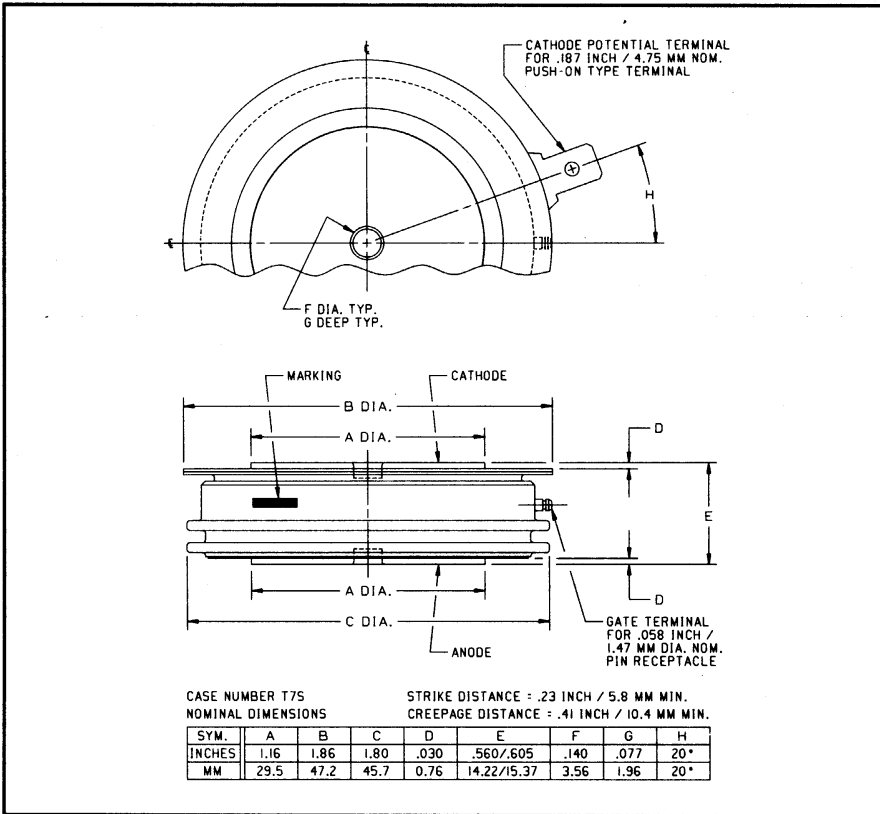

T7S0 750A (2400V) (Outline Drawing)

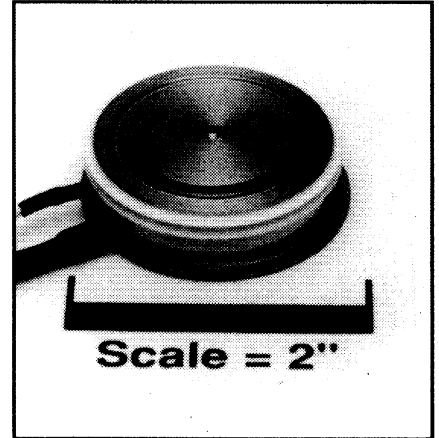

T7S0 750A (2400V) Phase Control SCR
750 Amperes Average, 1800-2400 Volts

Ordering Information:

Select the complete 12 digit part number you desire from the table below.

Type	Voltage	Current	Turn-off	Gate Current	Lead Code
	V_{DRM}/V_{RRM} (Volts)	$I_{T(av)}$ (A)	t_q (μ sec)	I_{GT} (mA)	
T7S0	18 20 24	75	0	4	DN
	1800V 2000V 2400V	750A	150 μ sec (Typical)	150mA	8"

Description:

Powerex Silicon Controlled Rectifiers (SCR) are designed for phase control applications. These are all-diffused, Press-Pak, hermetic Pow-R-Disc devices employing the field proven amplifying gate.

Features:

- Low On-State Voltage
- High di/dt Capability
- High dv/dt Capability
- Hermetic Packaging
- Excellent Surge and i^2t Ratings

Applications:

- Power Supplies
- Motor Control



Powerex, Inc., 200 Hillis Street, Youngwood, Pennsylvania 15697-1800 (412) 925-7272
Powerex, Europe, S.A. 428 Avenue G. Durand, BP107, 72003 Le Mans, France (43) 41.14.14

T7S0 750A (2400V)
Phase Control SCR
750 Amperes Average, 1800-2400 Volts

Absolute Maximum Ratings

Characteristics	Symbol	T7S0 750A (2400V)	Units
Non-repetitive Transient Peak Reverse Voltage	V_{RSM}	$V_{RRM} + 100V$	Volts
RMS On-state Current, $T_C = 73^\circ C$	$I_{T(rms)}$	1180	Amperes
Average Current 180° Sine Wave, $T_C = 73^\circ C$	$I_{T(av)}$	750	Amperes
RMS On-state Current, $T_C = 55^\circ C$	$I_{T(rms)}$	1440	Amperes
Average Current 180° Sine Wave, $T_C = 55^\circ C$	$I_{T(av)}$	920	Amperes
Peak One Cycle Surge On-state Current (Non-repetitive) 60Hz	I_{tsm}	10500	Amperes
Peak One Cycle Surge On-state Current (Non-repetitive) 50Hz	I_{tsm}	9600	Amperes
Critical Rate-of-rise of On-state Current (Non-repetitive)	di/dt	600	A/ μ sec
Critical Rate-of-rise of On-state Current (Repetitive)	di/dt	150	A/ μ sec
I^2t (for Fusing) for One Cycle, 60Hz	I^2t	460,000	A ² sec
Peak Gate Power Dissipation	P_{GM}	16	Watts
Average Gate Power Dissipation	$P_{G(av)}$	3	Watts
Operating Temperature	T_j	-40 to +125°C	°C
Storage Temperature	T_{stg}	-40 to +150°C	°C
Approximate Weight		4	oz.
		113	g
Mounting Force		2000 to 2400	lb.
		900 to 1090	kg.



Powerex, Inc., 200 Hillis Street, Youngwood, Pennsylvania 15697-1800 (412) 925-7272
 Powerex, Europe, S.A. 428 Avenue G. Durand, BP107, 72003 Le Mans, France (43) 41.14.14

T7S0 750A (2400V)
 Phase Control SCR
 750 Amperes Average, 1800-2400 Volts

Electrical Characteristics, $T_j = 25^\circ\text{C}$ Unless Otherwise Specified

Characteristics	Symbol	Test Conditions	Min.	Typ.	Max.	Units
Repetitive Peak Reverse Leakage Current	I_{RRM}	$T_j = 125^\circ\text{C}, V_R = V_{RRM}$			30	mA
Repetitive Peak Forward Leakage Current	I_{DRM}	$T_j = 125^\circ\text{C}, V_D = V_{DRM}$			30	mA
Peak On-state Voltage	V_{TM}	$I_{TM} = 625\text{A Peak}$ Duty Cycle < 0.1%			1.40	Volts
Threshold Voltage, Low-level	$V_{(TO)1}$	$T_j = 125^\circ\text{C}, I = 15\%, I_{T(av)}$ to $\pi I_{T(av)}$			0.97192	Volts
Slope Resistance, Low-level	r_{T1}				0.4818	m Ω
Threshold Voltage, High-level	$V_{(TO)2}$	$T_j = 125^\circ\text{C}, I = \pi I_{T(av)}$ to I_{TSM}			1.4824	Volts
Slope Resistance, High-level	r_{T2}				0.2845	m Ω
V_{TM} Coefficients, Low-level		$T_j = 125^\circ\text{C}, I = 15\% I_{T(av)}$ to $\pi I_{T(av)}$				$A_1 = 0.38516$ $B_1 = 0.12628$ $C_1 = 4.189\text{E-}04$ $D_1 = -0.005704$
V_{TM} Coefficients, High-level		$T_j = 125^\circ\text{C}, I = \pi I_{T(av)}$ to I_{TSM}				$A_2 = 2.1990$ $B_2 = -0.30712$ $C_2 = 4.831\text{E-}05$ $D_2 = 0.044366$
Typical Turn-on Time	t_{on}	$I_T = 100\text{A}, V_D = 100\text{V}$		7		μsec
Typical Turn-off Time	t_q	$T_j = 125^\circ\text{C}, I_T = 250\text{A},$ $di_R/dt = 25\text{A}/\mu\text{sec}$ Reapplied $dv/dt = 20\text{V}/\mu\text{sec}$ Linear to 80% V_{DRM}		150		μsec
Minimum Critical dv/dt - Exponential to V_{DRM}	dv/dt	$T_j = 125^\circ\text{C}$	300			$\text{V}/\mu\text{sec}$
Gate Trigger Current	I_{GT}	$T_j = 25^\circ\text{C}, V_D = 12\text{V}$			150	mA
Gate Trigger Voltage	V_{GT}	$T_j = 25^\circ\text{C}, V_D = 12\text{V}$			3.0	Volts
Non-Triggering Gate Voltage	V_{GDM}	$T_j = 125^\circ\text{C}, V_D = V_{DRM}$			0.15	Volts
Peak Forward Gate Current	I_{GTM}				4	A
Peak Reverse Gate Voltage	V_{GRM}				5	Volts

Thermal Characteristics

Maximum Thermal Resistance, Double Sided Cooling						
Junction-to-Case	$R_{\theta(j-c)}$				0.035	$^\circ\text{C}/\text{W}$
Case-to-Sink	$R_{\theta(c-s)}$				0.02	$^\circ\text{C}/\text{W}$

Powerex, Inc., 200 Hillis Street, Youngwood, Pennsylvania 15697-1800 (412) 925-7272
 Powerex, Europe, S.A. 428 Avenue G. Durand, BP107, 72003 Le Mans, France (43) 41.14.14

T750 750A (2400V)
Phase Control SCR
 750 Amperes Average, 1800-2400 Volts

Maximum On-State Forward Voltage Drop
 (T_J = 125 °C)

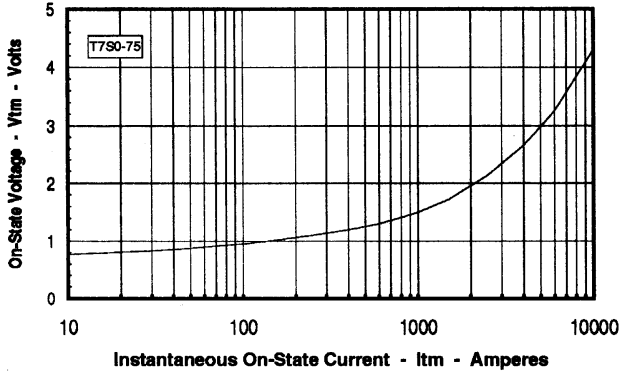

Maximum Transient Thermal Impedance
 (Junction to Case)

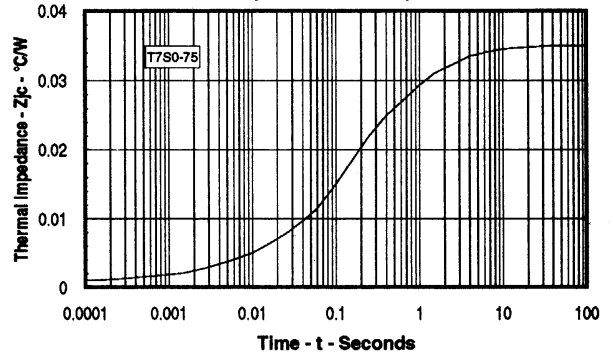

Maximum On-State Power Dissipation
 (Sinusoidal Waveform)

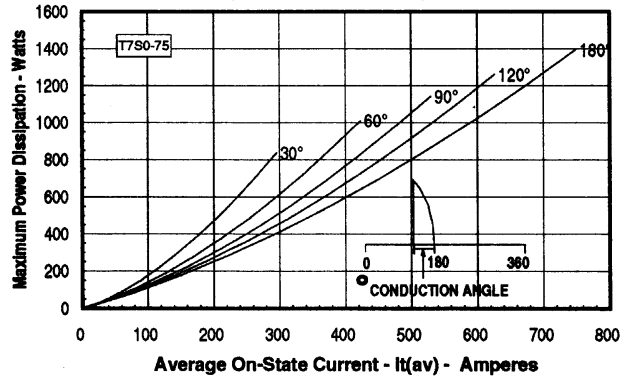

Maximum Allowable Case Temperature
 (Sinusoidal Waveform)

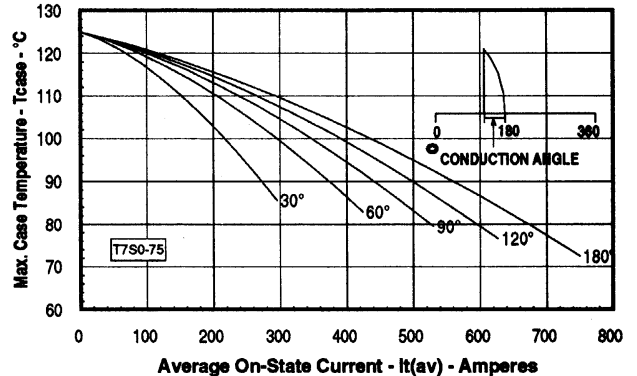

Maximum On-State Power Dissipation
 (Rectangular Waveform)

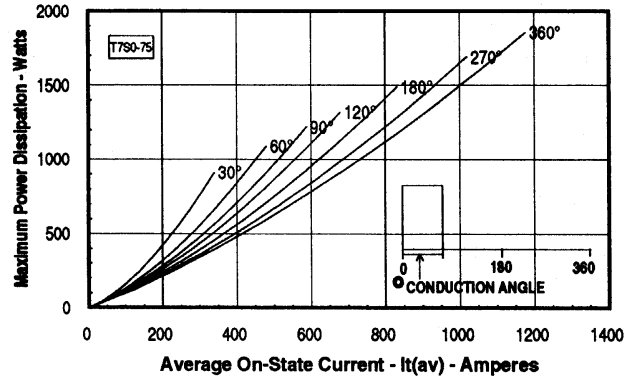

Maximum Allowable Case Temperature
 (Rectangular Waveform)

