

### Phase Control SCR 450-550 Amperes 2400 Volts

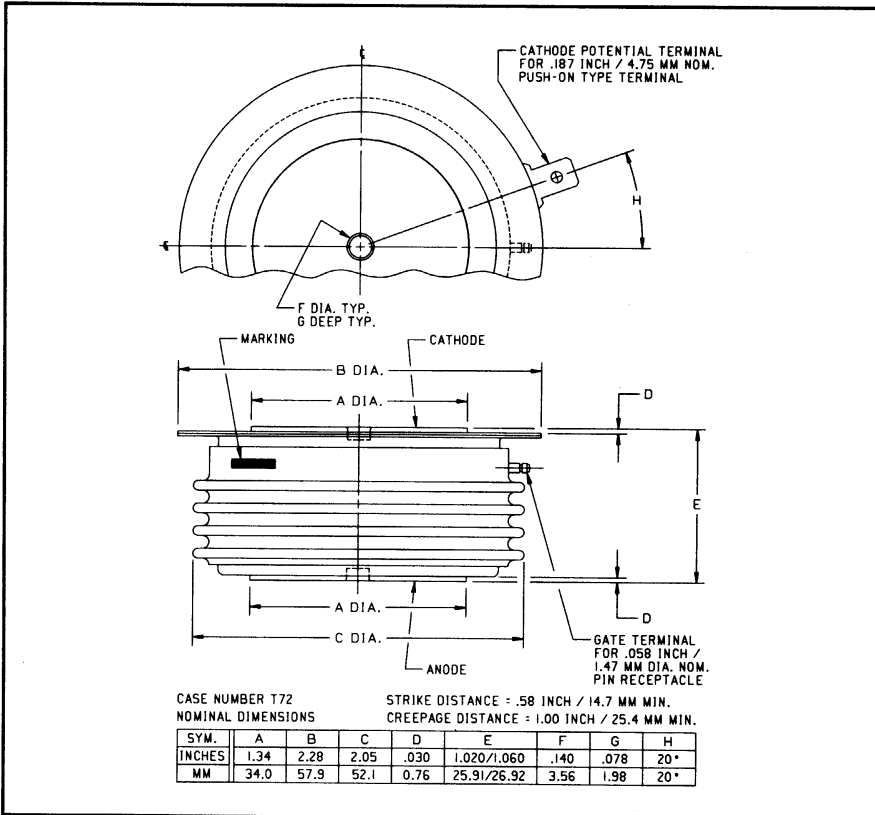

T720 (Outline Drawing)

#### Ordering Information:

Select the complete eight digit part number you desire from the table, i.e. T7202455 is a 2400 Volt, 550 Ampere Phase Control SCR.

Type	Voltage		Current	
	V <sub>DRM</sub>	V <sub>RRM</sub> Code	I <sub>T(av)</sub>	Code
T720	200	02	450	45
	600	06	550	55
	800	08		
	1000	10		
	1200	12		
	1400	14		
	1600	16		
	1800	18		
	2000	20		
	2200	22		
2400	24			



T720 Phase Control SCR  
 450-550 Amperes, 2400 Volts

#### Description:

Powerex Silicon Controlled Rectifiers (SCR) are designed for phase control applications. These are all-diffused, Press-Pak (Pow-R-Disc) devices employing the field-proven amplifying (di/namic) gate.

#### Features:

- Low On-State Voltage
- High di/dt
- High dv/dt
- Hermetic Packaging
- Excellent Surge and I<sup>2</sup>t Ratings

#### Applications:

- Power Supplies
- Battery Chargers
- Motor Control
- VAR Generators



Powerex, Inc., 200 Hillis Street, Youngwood, Pennsylvania 15697-1800 (412) 925-7272  
 Powerex, Europe, S.A. 428 Avenue G. Durand, BP107, 72003 Le Mans, France (43) 41.14.14

T720  
 Phase Control SCR  
 450-550 Amperes, 2400 Volts

### Absolute Maximum Ratings

	Symbol	T720 _ _ 45	T720 _ _ 55	Units
Maximum Blocking Voltage	$V_{DRM}, V_{RRM}$	2400	2400	Volts
RMS On-State Current	$I_{T(RMS)}$	700	850	Amperes
Average On-State Current	$I_{T(av)}$	450	550	Amperes
Peak One-Cycle Surge (Non-Repetitive) On-State Current (60Hz)	$I_{TSM}$	8400	10,000	Amperes
Peak One-Cycle Surge (Non-Repetitive) On-State Current (50Hz)	$I_{TSM}$	7650	9125	Amperes
Critical Rate-of-Rise of On-State Current (Non-Repetitive)	$di/dt$	600	600	Amperes/ $\mu$ s
Critical Rate-of-Rise of On-State Current (Repetitive)	$di/dt$	150	150	Amperes/ $\mu$ s
$I^2t$ (for Fusing), 8.3 milliseconds	$I^2t$	295,000	416,000	A <sup>2</sup> sec
Peak Gate Power Dissipation	$P_{GM}$	16	16	Watts
Average Gate Power Dissipation	$P_{G(av)}$	3	3	Watts
Storage Temperature	$T_{STG}$	-40 to 150	-40 to 150	$^{\circ}$ C
Operating Temperature	$T_J$	-40 to 125	-40 to 125	$^{\circ}$ C
Mounting Force		2000 to 2400	2000 to 2400	lb.
Mounting Force		900 to 1090	900 to 1090	kg

### Electrical and Thermal Characteristics

	Symbol	Test Conditions	T720 _ _ 45	T720 _ _ 55	Units
<b>Current—Conducting State Maximums</b>					
Peak On-State Voltage	$V_{TM}$	$I_{TM} = 625A, T_J = 25^{\circ}C$	1.60	1.40	Volts
<b>T720</b>					
<b>Voltage—Blocking State Maximums</b>					
Forward Leakage, Peak	$I_{DRM}$	$T_J = 125^{\circ}C, V_{DRM} = \text{rated}$	30		mA
Reverse Leakage, Peak	$I_{RRM}$	$T_J = 125^{\circ}C, V_{RRM} = \text{rated}$	30		mA
<b>Switching</b>					
Typical Turn-Off Time	$t_q$	$I_T = 250A, T_J = 125^{\circ}C,$ $di_r/dt = 25A/\mu\text{sec},$ reapplied $dv/dt = 20V/\mu\text{sec}$ linear to $0.8V_{DRM}$	150		$\mu\text{sec}$
Typical Turn-On Time	$t_{on}$	$I_T = 100A, V_D = 100V$	7		$\mu\text{sec}$
Min. Critical $dv/dt$ exponential to $V_{DRM}$	$dv/dt$	$T_J = 125^{\circ}C$	300		$V/\mu\text{sec}$
<b>Thermal</b>					
Maximum Thermal Resistance, double sided cooling Junction to Case	$R_{\theta JC}$		0.06		$^{\circ}C/\text{Watt}$
Case to Sink, Lubricated	$R_{\theta CS}$		0.02		$^{\circ}C/\text{Watt}$
<b>Gate—Maximum Parameters</b>					
Gate Current to Trigger	$I_{GT}$	$T_J = 25^{\circ}C, V_D = 12V$	150		mA
Gate Voltage to Trigger	$V_{GT}$	$T_J = 25^{\circ}C, V_D = 12V$	3		Volts
Non-Triggering Gate Voltage	$V_{GDM}$	$T_J = 125^{\circ}C, \text{rated } V_{DRM}$	0.15		Volts
Peak Forward Gate Current	$I_{GTM}$		4		Amperes
Peak Reverse Gate Voltage	$V_{GRM}$		5		Volts

Powerex, Inc., 200 Hillis Street, Youngwood, Pennsylvania 15697-1800 (412) 925-7272  
 Powerex, Europe, S.A. 428 Avenue G. Durand, BP107, 72003 Le Mans, France (43) 41.14.14

**T720**  
**Phase Control SCR**  
 450-550 Amperes, 2400 Volts

**MAXIMUM ON-STATE CHARACTERISTICS**

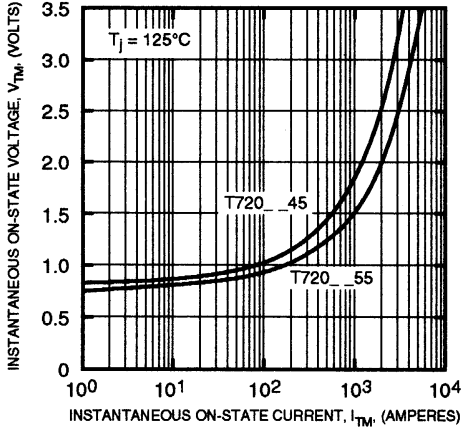

**TRANSIENT THERMAL IMPEDANCE CHARACTERISTICS (JUNCTION TO CASE)**

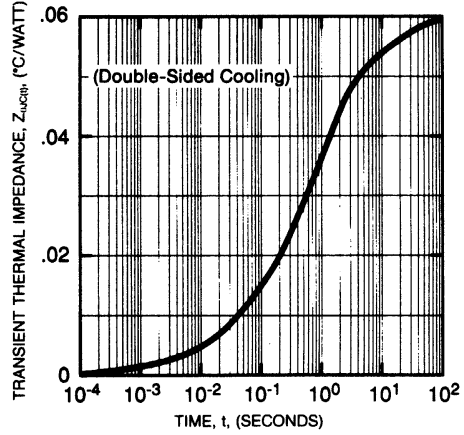

**MAXIMUM ALLOWABLE CASE TEMPERATURE (SINUSOIDAL WAVEFORM)**

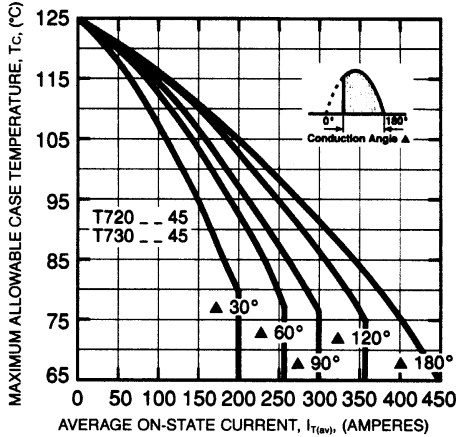

**MAXIMUM ON-STATE POWER DISSIPATION (SINUSOIDAL WAVEFORM)**

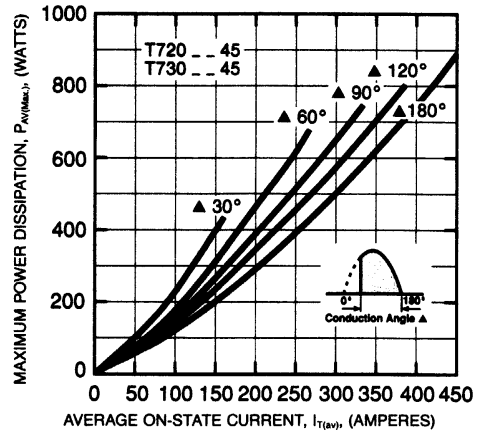

**MAXIMUM ALLOWABLE CASE TEMPERATURE (RECTANGULAR WAVEFORM)**

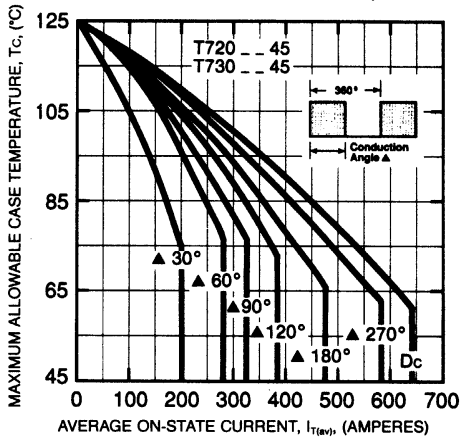

**MAXIMUM ON-STATE POWER DISSIPATION (RECTANGULAR WAVEFORM)**

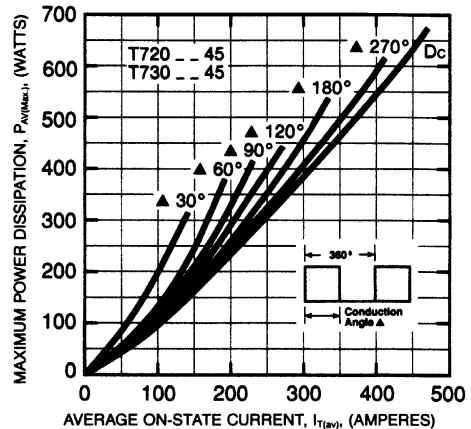

Powerex, Inc., 200 Hillis Street, Youngwood, Pennsylvania 15697-1800 (412) 925-7272  
 Powerex, Europe, S.A. 428 Avenue G. Durand, BP107, 72003 Le Mans, France (43) 41.14.14

**T720**  
**Phase Control SCR**  
 450-550 Amperes, 2400 Volts

