

Powerex, Inc., 200 Hillis Street, Youngwood, Pennsylvania 15697-1800 (412) 925-7272
 Powerex, Europe, S.A. 428 Avenue G. Durand, BP107, 72003 Le Mans, France (43) 41.14.14

Phase Control SCR
 300-400 Amperes
 1200 Volts

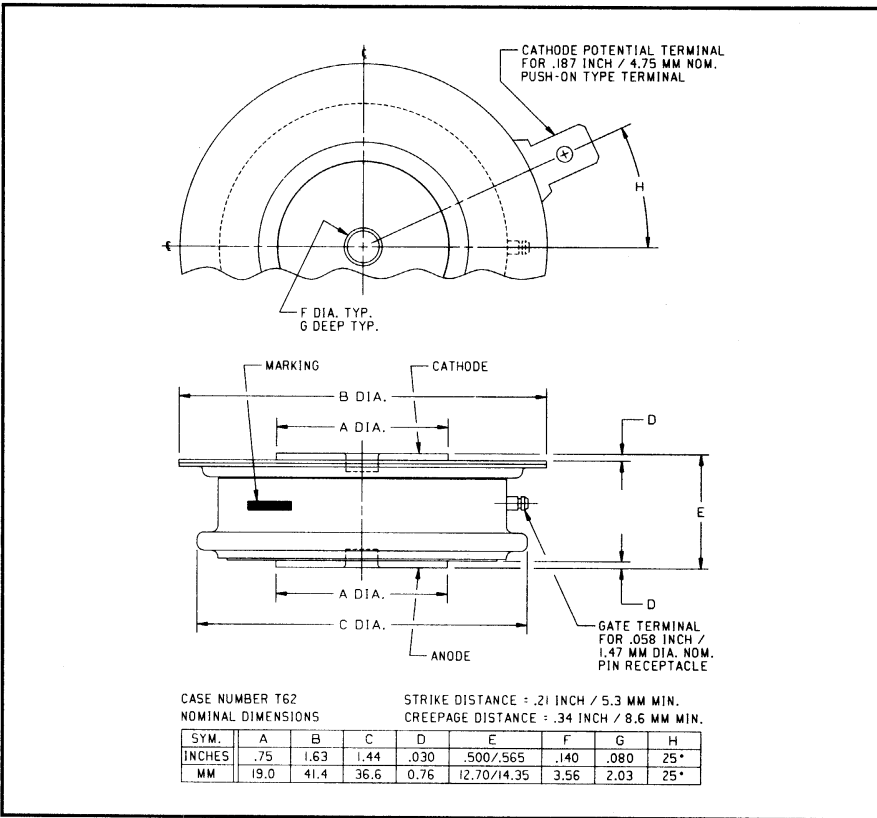

T625 (Outline Drawing)

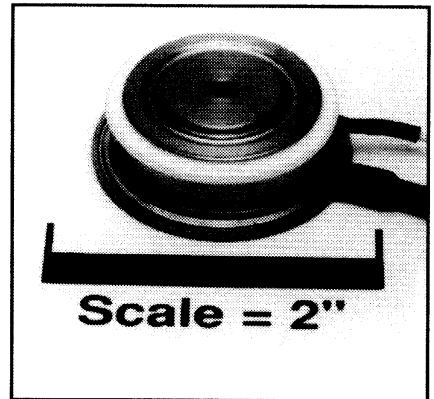

T625 Phase Control SCR
 300-400 Amperes, 1200 Volts

Description:

Powerex Silicon Controlled Rectifiers (SCR) are designed for phase control applications. These are all-diffused, Press-Pak (Pow-R-Disc) devices employing the field-proven amplifying (di/namic) gate.

Features:

- Low On-State Voltage
- High di/dt
- High dv/dt
- Hermetic Packaging
- Excellent Surge and I^2t Ratings
- 150°C Junction Temperature Rating

Applications:

- Power Supplies
- Battery Chargers
- Motor Control
- Welders

Ordering Information:

Select the complete eight digit part number you desire from the table, i.e. T6251230 is a 1200 Volt, 300 Ampere Phase Control SCR.

| Type | Voltage | | Current | |
|------|------------------------|------|-------------|------|
| | V_{DRM} V_{RRM} | Code | $I_{T(av)}$ | Code |
| T625 | 200 | 02 | 300 | 30 |
| | 400 | 04 | 400 | 40 |
| | 600 | 06 | | |
| | 800 | 08 | | |
| | 1000 | 10 | | |
| | 1200 | 12 | | |



Powerex, Inc., 200 Hillis Street, Youngwood, Pennsylvania 15697-1800 (412) 925-7272
 Powerex, Europe, S.A. 428 Avenue G. Durand, BP107, 72003 Le Mans, France (43) 41.14.14

T625
Phase Control SCR
 300-400 Amperes, 1200 Volts

Absolute Maximum Ratings

| | Symbol | T625 _ _ 30 | T625 _ _ 40 | Units |
|---|--------------|--------------|--------------|--------------------|
| RMS On-State Current | $I_{T(RMS)}$ | 470 | 625 | Amperes |
| Average On-State Current | $I_{T(av)}$ | 300 | 400 | Amperes |
| Peak One-Cycle Surge (Non-Repetitive) On-State Current (60Hz) | I_{TSM} | 3600 | 5000 | Amperes |
| Peak One-Cycle Surge (Non-Repetitive) On-State Current (50Hz) | I_{TSM} | 3300 | 4550 | Amperes |
| Critical Rate-of-Rise of On-State Current (Non-Repetitive) | di/dt | 800 | 800 | Amperes/ μ s |
| Critical Rate-of-Rise of On-State Current (Repetitive) | di/dt | 200 | 200 | Amperes/ μ s |
| I^2t (for Fusing), 8.3 milliseconds | I^2t | 54,000 | 100,000 | A ² sec |
| Peak Gate Power Dissipation | P_{GM} | 16 | 16 | Watts |
| Average Gate Power Dissipation | $P_{G(av)}$ | 3 | 3 | Watts |
| Storage Temperature | T_{STG} | -40 to 150 | -40 to 150 | $^{\circ}$ C |
| Operating Temperature | T_J | -40 to 150 | -40 to 150 | $^{\circ}$ C |
| Mounting Force | | 1000 to 1400 | 1000 to 1400 | lb. |
| Mounting Force | | 450 to 635 | 450 to 635 | kg |

Electrical and Thermal Characteristics

| | Symbol | Test Conditions | T625 _ _ 30 | T625 _ _ 40 | Units |
|--|-----------------|--|-------------|-------------|-------------------------|
| Current—Conducting State Maximums | | | | | |
| Peak On-State Voltage | V_{TM} | $I_{TM} = 625A, T_J = 25^{\circ}C$ | 2.05 | 1.55 | Volts |
| T625 | | | | | |
| Voltage—Blocking State Maximums | | | | | |
| Forward Leakage, Peak | I_{DRM} | $T_J = 150^{\circ}C, V_{DRM} = \text{rated}$ | 50 | | mA |
| Reverse Leakage, Peak | I_{RRM} | $T_J = 150^{\circ}C, V_{RRM} = \text{rated}$ | 50 | | mA |
| Switching | | | | | |
| Typical Turn-Off Time | t_q | $I_T = 150A, T_J = 150^{\circ}C,$ $di_R/dt = 12.5A/\mu\text{sec, reapplied}$ $dv/dt = 20V/\mu\text{sec linear to } 0.8V_{DRM}$ | 150 | | μsec |
| Typical Turn-On Time | t_{on} | $I_T = 100A, V_D = 500V$ | 3 | | μsec |
| Min. Critical dv/dt exponential to V_{DRM} | dv/dt | $T_J = 150^{\circ}C$ | 300 | | V/ μsec |
| Thermal | | | | | |
| Maximum Thermal Resistance, double sided cooling | | | | | |
| Junction to Case | $R_{\theta JC}$ | | 0.08 | | $^{\circ}C/\text{Watt}$ |
| Case to Sink, Lubricated | $R_{\theta CS}$ | | 0.02 | | $^{\circ}C/\text{Watt}$ |
| Gate—Maximum Parameters | | | | | |
| Gate Current to Trigger | I_{GT} | $T_J = 25^{\circ}C, V_D = 12V$ | 150 | | mA |
| Gate Voltage to Trigger | V_{GT} | $T_J = 25^{\circ}C, V_D = 12V$ | 3 | | Volts |
| Non-Triggering Gate Voltage | V_{GDM} | $T_J = 150^{\circ}C, \text{rated } V_{DRM}$ | 0.25 | | Volts |
| Peak Forward Gate Current | I_{GTM} | | 4 | | Amperes |
| Peak Reverse Gate Voltage | V_{GRM} | | 5 | | Volts |

Powerex, Inc., 200 Hillis Street, Youngwood, Pennsylvania 15697-1800 (412) 925-7272
 Powerex, Europe, S.A. 428 Avenue G. Durand, BP107, 72003 Le Mans, France (43) 41.14.14

T625
Phase Control SCR
 300-400 Amperes, 1200 Volts

MAXIMUM ON-STATE CHARACTERISTICS

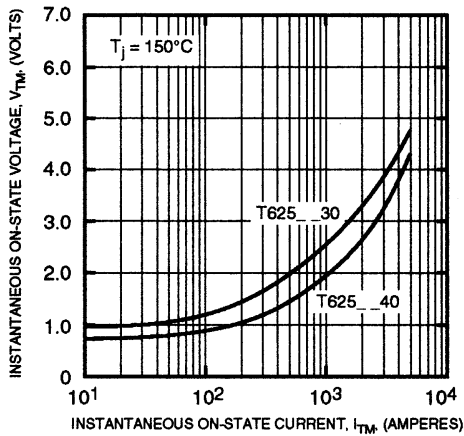

TRANSIENT THERMAL IMPEDANCE CHARACTERISTICS (JUNCTION TO CASE)

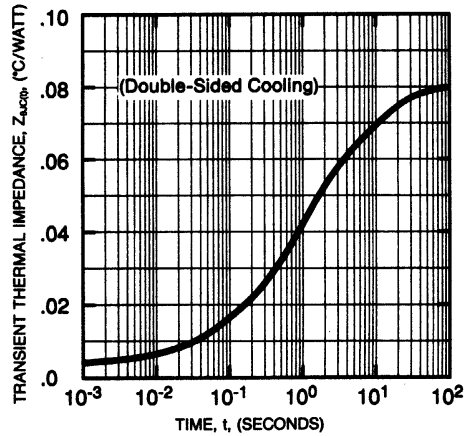

MAXIMUM ALLOWABLE CASE TEMPERATURE (SINUSOIDAL WAVEFORM)

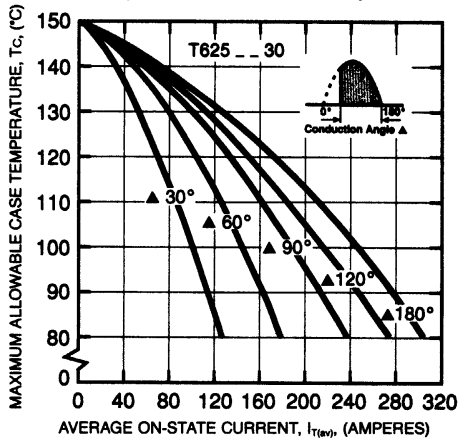

MAXIMUM ON-STATE POWER DISSIPATION (SINUSOIDAL WAVEFORM)

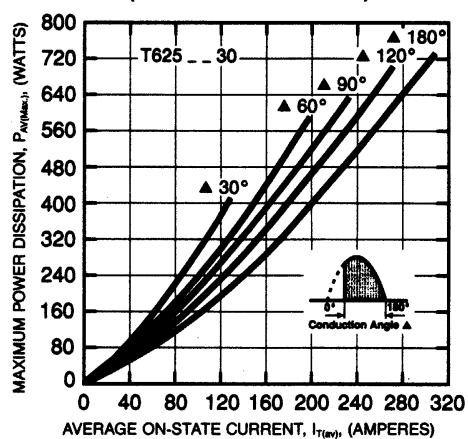

MAXIMUM ALLOWABLE CASE TEMPERATURE (RECTANGULAR WAVEFORM)

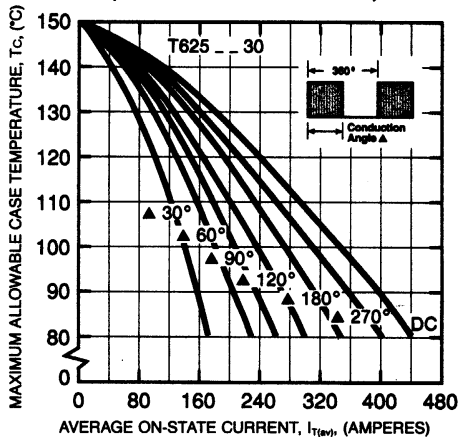

MAXIMUM ON-STATE POWER DISSIPATION (RECTANGULAR WAVEFORM)

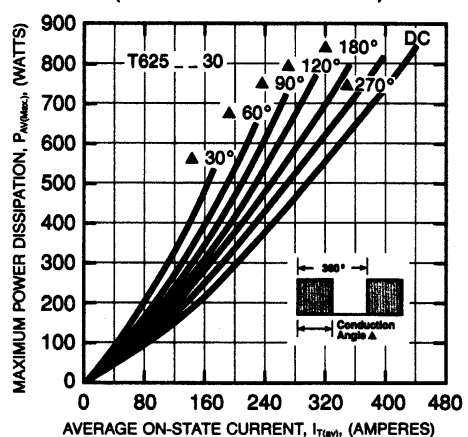

Powerex, Inc., 200 Hillis Street, Youngwood, Pennsylvania 15697-1800 (412) 925-7272
 Powerex, Europe, S.A. 428 Avenue G. Durand, BP107, 72003 Le Mans, France (43) 41.14.14

T625
Phase Control SCR
 300-400 Amperes, 1200 Volts

