

Powerex, Inc., 200 Hillis Street, Youngwood, Pennsylvania 15697-1800 (412) 925-7272  
 Powerex, Europe, S.A. 428 Avenue G. Durand, BP107, 72003 Le Mans, France (43) 41.14.14

**Phase Control SCR**  
 300-400 Amperes  
 1200 Volts

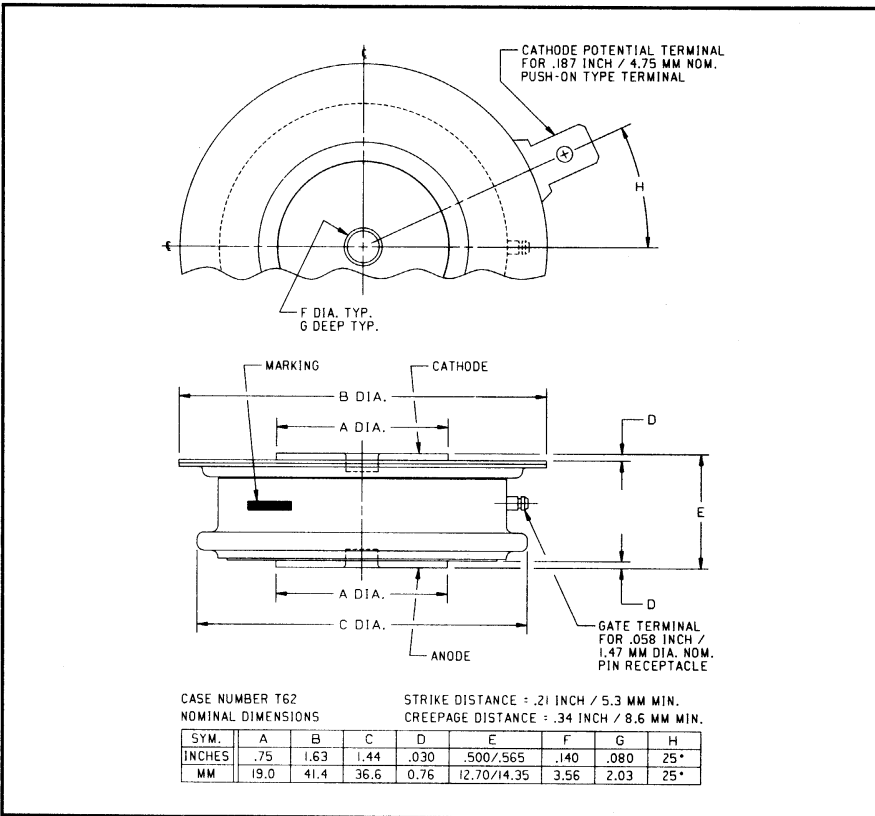

T625 (Outline Drawing)

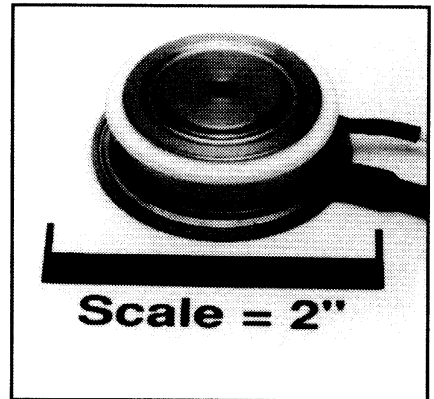

T625 Phase Control SCR  
 300-400 Amperes, 1200 Volts

### Description:

Powerex Silicon Controlled Rectifiers (SCR) are designed for phase control applications. These are all-diffused, Press-Pak (Pow-R-Disc) devices employing the field-proven amplifying (di/namic) gate.

### Features:

- Low On-State Voltage
- High di/dt
- High dv/dt
- Hermetic Packaging
- Excellent Surge and  $I^2t$  Ratings
- 150°C Junction Temperature Rating

### Applications:

- Power Supplies
- Battery Chargers
- Motor Control
- Welders

### Ordering Information:

Select the complete eight digit part number you desire from the table, i.e. T6251230 is a 1200 Volt, 300 Ampere Phase Control SCR.

Type	Voltage		Current	
	$V_{DRM}$ $V_{RRM}$	Code	$I_{T(av)}$	Code
T625	200	02	300	30
	400	04	400	40
	600	06		
	800	08		
	1000	10		
	1200	12		



Powerex, Inc., 200 Hillis Street, Youngwood, Pennsylvania 15697-1800 (412) 925-7272  
 Powerex, Europe, S.A. 428 Avenue G. Durand, BP107, 72003 Le Mans, France (43) 41.14.14

**T625**  
**Phase Control SCR**  
 300-400 Amperes, 1200 Volts

### Absolute Maximum Ratings

	Symbol	T625 _ _ 30	T625 _ _ 40	Units
RMS On-State Current	$I_{T(RMS)}$	470	625	Amperes
Average On-State Current	$I_{T(av)}$	300	400	Amperes
Peak One-Cycle Surge (Non-Repetitive) On-State Current (60Hz)	$I_{TSM}$	3600	5000	Amperes
Peak One-Cycle Surge (Non-Repetitive) On-State Current (50Hz)	$I_{TSM}$	3300	4550	Amperes
Critical Rate-of-Rise of On-State Current (Non-Repetitive)	di/dt	800	800	Amperes/ $\mu$ s
Critical Rate-of-Rise of On-State Current (Repetitive)	di/dt	200	200	Amperes/ $\mu$ s
$I^2t$ (for Fusing), 8.3 milliseconds	$I^2t$	54,000	100,000	A <sup>2</sup> sec
Peak Gate Power Dissipation	$P_{GM}$	16	16	Watts
Average Gate Power Dissipation	$P_{G(av)}$	3	3	Watts
Storage Temperature	$T_{STG}$	-40 to 150	-40 to 150	°C
Operating Temperature	$T_J$	-40 to 150	-40 to 150	°C
Mounting Force		1000 to 1400	1000 to 1400	lb.
Mounting Force		450 to 635	450 to 635	kg

### Electrical and Thermal Characteristics

	Symbol	Test Conditions	T625 _ _ 30	T625 _ _ 40	Units
<b>Current—Conducting State Maximums</b>					
Peak On-State Voltage	$V_{TM}$	$I_{TM} = 625A, T_J = 25^\circ C$	2.05	1.55	Volts
<b>T625</b>					
<b>Voltage—Blocking State Maximums</b>					
Forward Leakage, Peak	$I_{DRM}$	$T_J = 150^\circ C, V_{DRM} = \text{rated}$	50		mA
Reverse Leakage, Peak	$I_{RRM}$	$T_J = 150^\circ C, V_{RRM} = \text{rated}$	50		mA
<b>Switching</b>					
Typical Turn-Off Time	$t_q$	$I_T = 150A, T_J = 150^\circ C,$ $di_R/dt = 12.5A/\mu\text{sec, reapplied}$ $dv/dt = 20V/\mu\text{sec linear to } 0.8V_{DRM}$	150		$\mu\text{sec}$
Typical Turn-On Time	$t_{on}$	$I_T = 100A, V_D = 500V$	3		$\mu\text{sec}$
Min. Critical dv/dt exponential to $V_{DRM}$	dv/dt	$T_J = 150^\circ C$	300		V/ $\mu\text{sec}$
<b>Thermal</b>					
Maximum Thermal Resistance, double sided cooling					
Junction to Case	$R_{\theta JC}$		0.08		°C/Watt
Case to Sink, Lubricated	$R_{\theta CS}$		0.02		°C/Watt
<b>Gate—Maximum Parameters</b>					
Gate Current to Trigger	$I_{GT}$	$T_J = 25^\circ C, V_D = 12V$	150		mA
Gate Voltage to Trigger	$V_{GT}$	$T_J = 25^\circ C, V_D = 12V$	3		Volts
Non-Triggering Gate Voltage	$V_{GDM}$	$T_J = 150^\circ C, \text{rated } V_{DRM}$	0.25		Volts
Peak Forward Gate Current	$I_{GTM}$		4		Amperes
Peak Reverse Gate Voltage	$V_{GRM}$		5		Volts

**T625**  
**Phase Control SCR**  
 300-400 Amperes, 1200 Volts

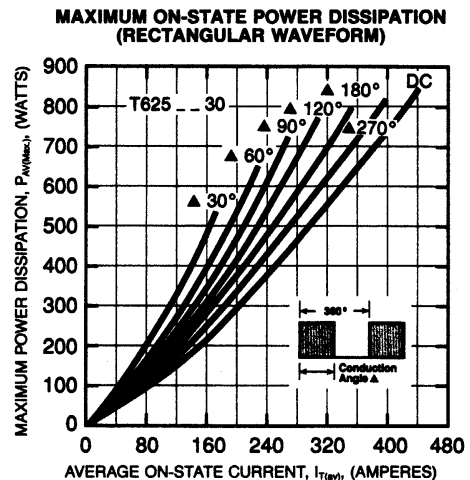
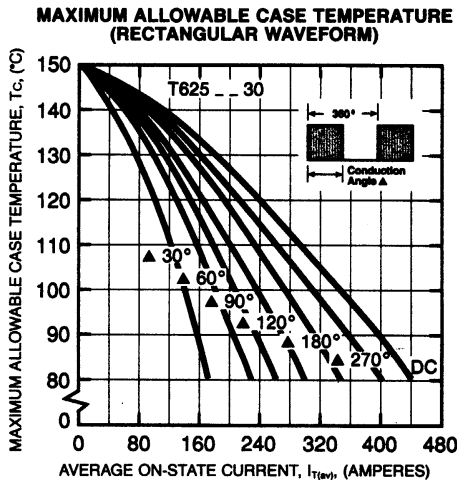
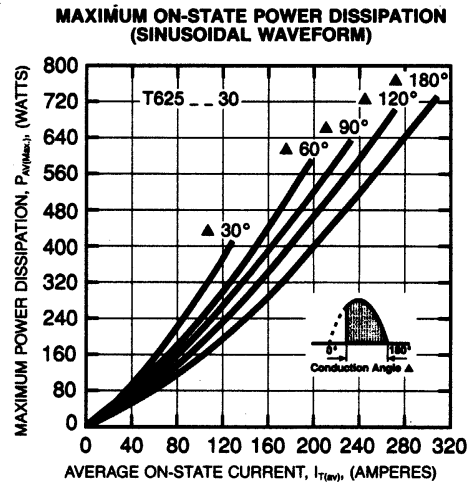
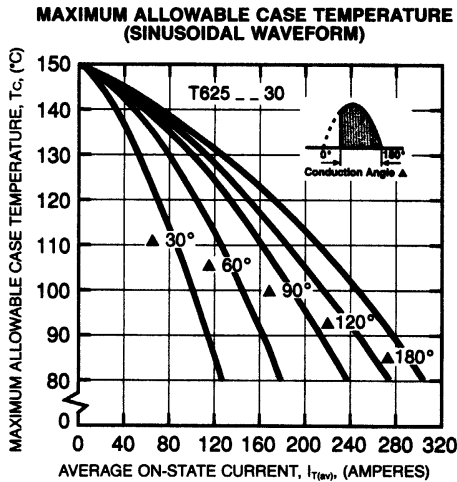
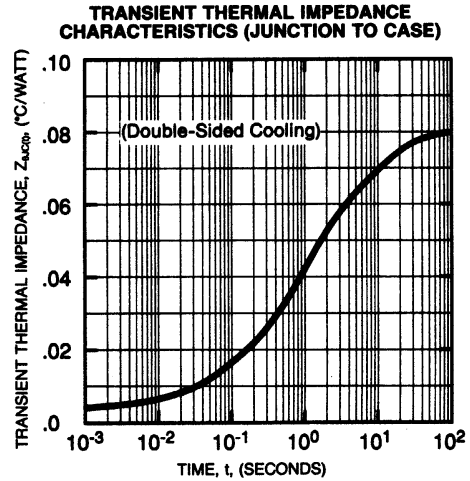
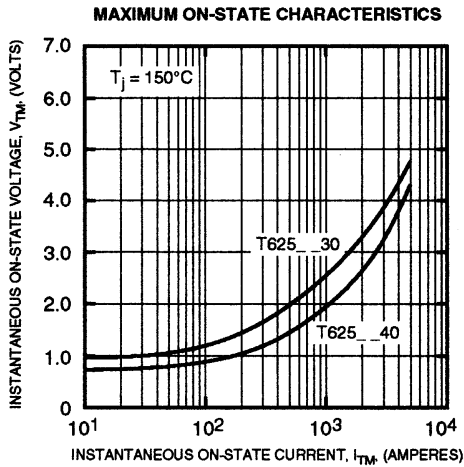

Powerex, Inc., 200 Hillis Street, Youngwood, Pennsylvania 15697-1800 (412) 925-7272  
 Powerex, Europe, S.A. 428 Avenue G. Durand, BP107, 72003 Le Mans, France (43) 41.14.14

**T625**  
**Phase Control SCR**  
 300-400 Amperes, 1200 Volts

