

Powerex, Inc., 200 Hillis Street, Youngwood, Pennsylvania 15697-1800 (412) 925-7272
 Powerex, Europe, S.A. 428 Avenue G. Durand, BP107, 72003 Le Mans, France (43) 41.14.14

Phase Control SCR
 200-300 Amperes
 1600 Volts

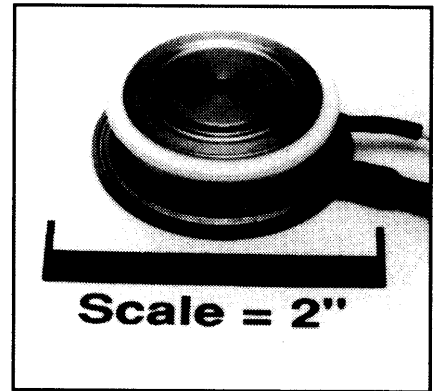
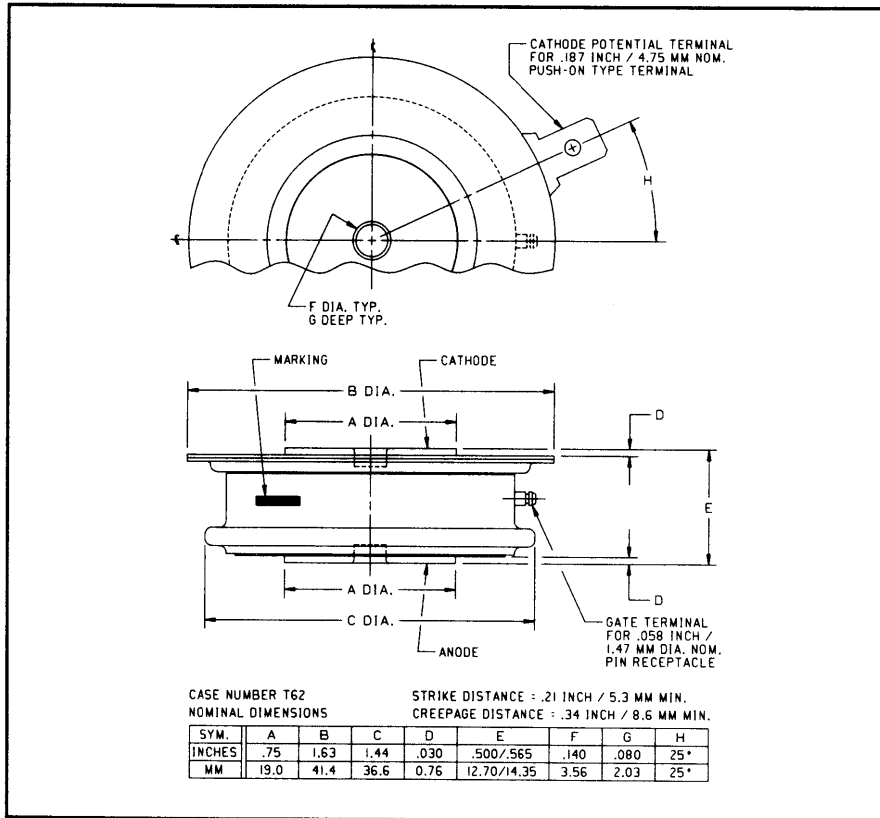

T620 Phase Control SCR
 200-300 Amperes, 1600 Volts

T620 (Outline Drawing)

Description:

Powerex Silicon Controlled Rectifiers (SCR) are designed for phase control applications. These are all-diffused, Press-Pak (Pow-R-Disc) devices employing the field-proven amplifying (di/namic) gate.

Features:

- Low On-State Voltage
- High di/dt
- High dv/dt
- Hermetic Packaging
- Excellent Surge and I^2t Ratings

Applications:

- Power Supplies
- Battery Chargers
- Motor Control
- Welders

Ordering Information:

Select the complete eight digit part number you desire from the table, i.e. T6201620 is a 1600 Volt, 200 Ampere Phase Control SCR.

Type	Voltage		Current	
	V_{RRM}	Code	$I_{T(av)}$	Code
T620	200	02	200	20
	400	04	300	30
	600	06		
	800	08		
	1000	10		
	1200	12		
	1400	14		
	1600	16		



Powerex, Inc., 200 Hillis Street, Youngwood, Pennsylvania 15697-1800 (412) 925-7272
 Powerex, Europe, S.A. 428 Avenue G. Durand, BP107, 72003 Le Mans, France (43) 41.14.14

T620
 Phase Control SCR
 200-300 Amperes, 1600 Volts

Absolute Maximum Ratings

	Symbol	T620 -- 20	T620 -- 30	Units
RMS On-State Current	$I_{T(RMS)}$	315	470	Amperes
Average On-State Current	$I_{T(av)}$	200	300	Amperes
Peak One-Cycle Surge (Non-Repetitive) On-State Current (60Hz)	I_{TSM}	4000	5500	Amperes
Peak One-Cycle Surge (Non-Repetitive) On-State Current (50Hz)	I_{TSM}	3650	5000	Amperes
Critical Rate-of-Rise of On-State Current (Non-Repetitive)	di/dt	800	800	Amperes/ μ s
Critical Rate-of-Rise of On-State Current (Repetitive)	di/dt	150	150	Amperes/ μ s
I^2t (for Fusing), 8.3 milliseconds	I^2t	64,400	120,000	A ² sec
Peak Gate Power Dissipation	P_{GM}	16	16	Watts
Average Gate Power Dissipation	$P_{G(av)}$	3	3	Watts
Storage Temperature	T_{STG}	-40 to 150	-40 to 150	°C
Operating Temperature	T_J	-40 to 125	-40 to 125	°C
Mounting Force		1000 to 1400	1000 to 1400	lb.
Mounting Force		450 to 635	450 to 635	kg

Electrical and Thermal Characteristics

Characteristics	Symbol	Test Conditions	T620 -- 20	T620 -- 30	Units
Current—Conducting State Maximums					
Peak On-State Voltage	V_{TM}	$I_{TM} = 625A, T_J = 25^\circ C$	2.05	1.55	Volts
T620					
Voltage—Blocking State Maximums					
Forward Leakage, Peak	I_{DRM}	$T_J = 125^\circ C, V_{DRM} = \text{rated}$	25		mA
Reverse Leakage, Peak	I_{RRM}	$T_J = 125^\circ C, V_{RRM} = \text{rated}$	25		mA
Switching					
Typical Turn-Off Time	t_q	$I_T = 150A, T_J = 125^\circ C,$ $di_R/dt = 12.5A/\mu\text{sec},$ reapplied $dv/dt = 20V/\mu\text{sec}$ linear to $0.8V_{DRM}$	100		μsec
Typical Turn-On Time	t_{on}	$I_T = 100A, V_D = 100V$	5		μsec
Min. Critical dv/dt exponential to V_{DRM}	dv/dt	$T_J = 125^\circ C$	300		V/ μsec
Thermal					
Maximum Thermal Resistance, double sided cooling Junction to Case	R_{BJC}		0.08		°C/Watt
Case to Sink, Lubricated	R_{BCS}		0.02		°C/Watt
Gate—Maximum Parameters					
Gate Current to Trigger	I_{GT}	$T_J = 25^\circ C, V_D = 12V$	150		mA
Gate Voltage to Trigger	V_{GT}	$T_J = 25^\circ C, V_D = 12V$	3		Volts
Non-Triggering Gate Voltage	V_{GDM}	$T_J = 125^\circ C, \text{rated } V_{DRM}$	0.15		Volts
Peak Forward Gate Current	I_{GTM}		4		Amperes
Peak Reverse Gate Voltage	V_{GRM}		5		Volts

T620
Phase Control SCR
 200-300 Amperes, 1600 Volts

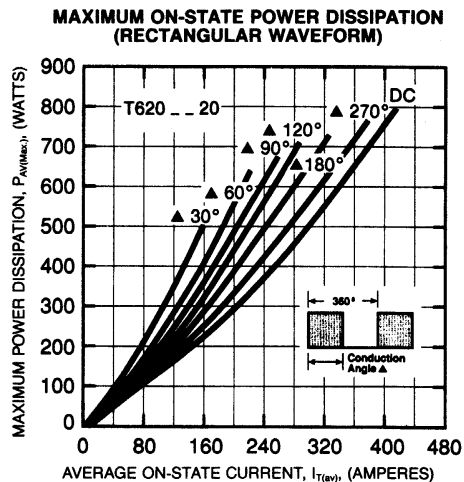
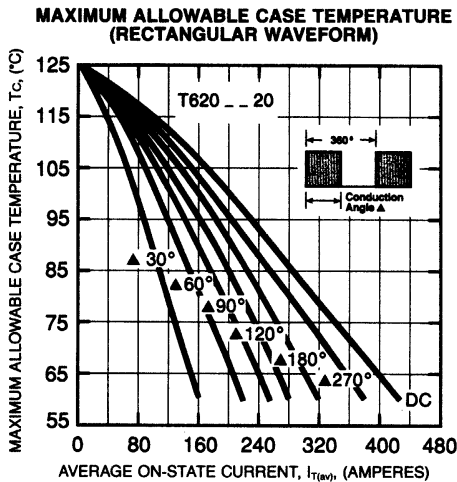
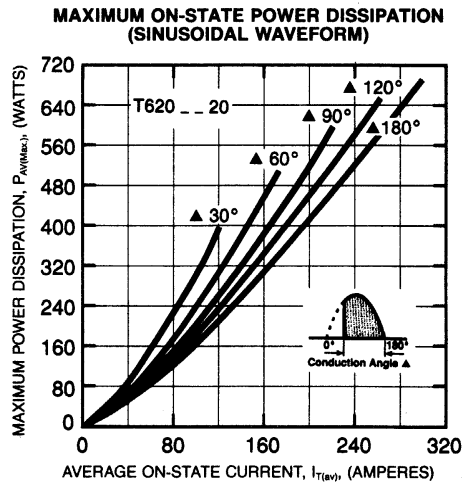
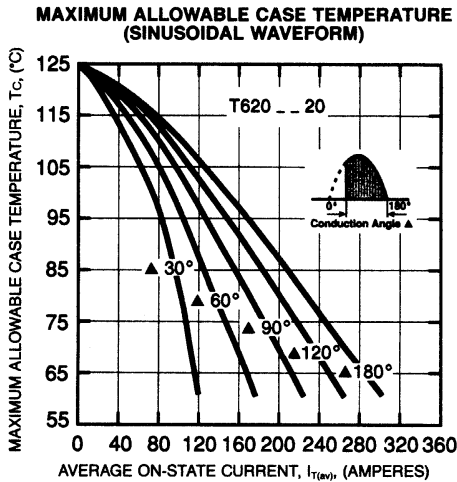
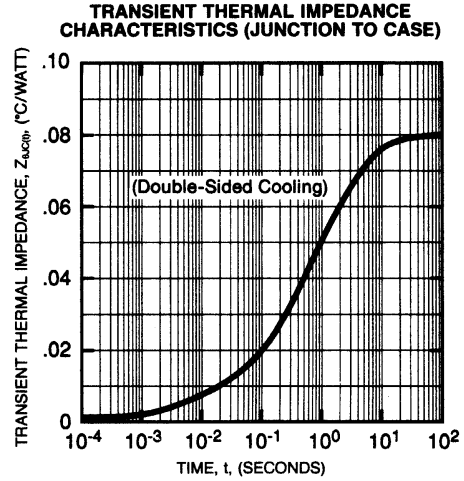
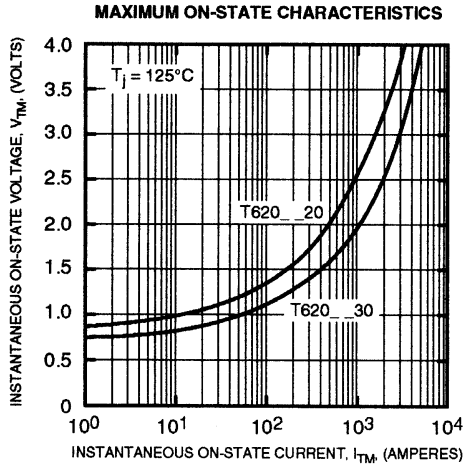

Powerex, Inc., 200 Hillis Street, Youngwood, Pennsylvania 15697-1800 (412) 925-7272
 Powerex, Europe, S.A. 428 Avenue G. Durand, BP107, 72003 Le Mans, France (43) 41.14.14

T620
Phase Control SCR
 200-300 Amperes, 1600 Volts

