

Fast Switching SCR T507_70

70A Avg.
(110 RMS)
Up to 1400 Volts
10-50 μ s

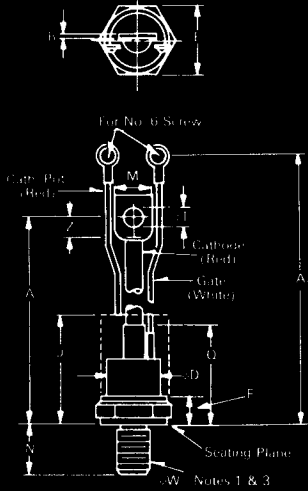

Conforms to TO-94 Outline

Symbol	Inches		Millimeters	
	Min.	Max.	Min.	Max.
A	5.775	6.265	146.69	159.13
A ₁	6.850	7.500	173.99	190.50
B	.055	.075	1.40	1.91
ϕ D	.860	1.000	21.84	25.40
E	1.031	1.063	26.19	27.00
F	.255	.400	6.48	10.16
J	2.50		63.50	
M	.437	.650	11.10	16.51
N	.796	.827	20.24	21.01
Q		1.675		42.55
ϕ T	.260	.291	6.60	7.39
Z	.250		6.35	
ϕ W	$\frac{1}{2}$ -20 UNF-2A			

Creep & Strike Distance.
T500—.50 in. min. (12.85 mm).
(In accordance with NEMA standards.)
Finish—Nickel Plate.

- Approx. Weight—5 oz. (142 g).
- Complete threads to extend to within 2½ threads of seating plane.
 - Angular orientation of terminals is undefined.
 - Pitch diameter of $\frac{1}{2}$ -20 UNF-2A (coated) threads (ASA B1.1-1960).
 - Dimension "J" denotes seated height with leads bent at right angles.

*for 10 μ sec turn-off,
consult factory

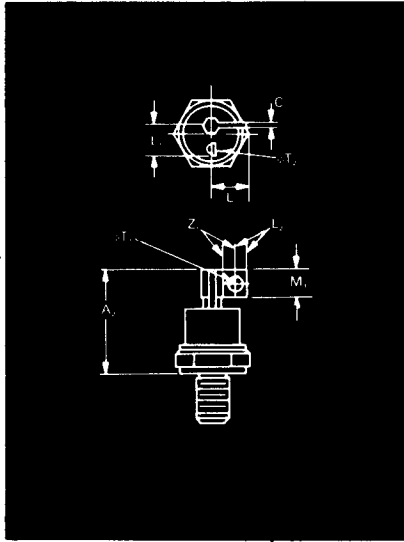

Conforms to TO-83 Outline

Symbol	Inches		Millimeters	
	Min.	Max.	Min.	Max.
A ₂		1.810		45.97
C	.070	.110	1.78	2.79
L		.650		16.51
L ₁	.420	.520	10.67	13.21
L ₂	.180		4.57	
M ₁	.360	.470	9.14	11.94
ϕ T ₁	.190	.235	4.83	5.97
ϕ T ₂	.060	.080	1.52	2.03
Z ₁	.180		4.57	
ϕ W	$\frac{1}{2}$ -20 UNF-2A			

Approx. Weight—4 oz. (114 g).
1. Basic dimensions of TO-94 and TO-83 are same except as noted.

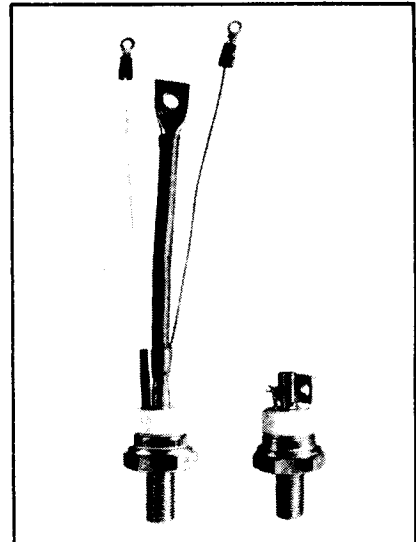

Features:

- Center fired di/namic
- High di/dt with soft gate control
- High frequency operation
- Sinusoidal waveform operation to 20 KHz
- Rectangular waveform operation to 20 KHz
- Low dynamic forward voltage drop
- Low switching losses at high frequency
- Lifetime Guarantee

Applications:

- Inverters for UPS
- Induction Heating
- AC Motor Control
- Switching power supplies
- Cycloconverters
- Choppers
- Crowbars

Ordering Information

Type	Voltage		Current		Turn-off		Gate current		Leads	
	V _{DRM} and V _{RRM} (V)	Code	I _{T(av)} (A)	Code	t _q (μ sec)	Code	I _{GT} (ma)	Code	Case	Code
T507	100	01	70	70	10	0	150	4	TO-94	00
	200	02								01
	300	03								02
	400	04								03
	500	05								04
	600	06								05
	700	07								06
	800	08								07
	900	09								08
	1000	10								09
	1100	11								10
	1200	12								11
	1400	14								12

Type	Voltage	Current	Turn Off	Gate Current	Leads
T 5 0 7 0 8 9 0	5	0	8	9	0
	6	4	A	Q	

Example

Obtain optimum device performance for your application by selecting proper Order Code.

Type T 507 rated at 70 A average with V_{DRM} = 800V.
I_{GT} = 150 ma, t_q = 20 μ sec max. and flex leads—order as:

**70A Avg.
(110 RMS)
Up to 1400 Volts
10-50 μ s**

**Fast Switching
SCR
T507__70**

Voltage

Blocking State Maximums @ ($T_J = 125^\circ\text{C}$)

	Symbol	100	200	300	400	500	600	700	800	900	1000	1100	1200	1400
Repetitive peak forward blocking voltage, V	V_{DRM}	100	200	300	400	500	600	700	800	900	1000	1100	1200	1400
Repetitive peak reverse voltage, V	V_{RRM}	100	200	300	400	500	600	700	800	900	1000	1100	1200	1400
Non-repetitive transient peak reverse voltage, $t \leq 5.0$ msec, V	V_{RSM}	200	300	400	500	600	700	800	900	1000	1100	1200	1300	1500
Forward leakage current, mA peak	I_{DRM}	← 15 →												
Reverse leakage current, mA peak	I_{RRM}	← 15 →												

Current

**Conducting State Maximums
($T_J = 125^\circ\text{C}$)**

	Symbol	T507__70
RMS forward current, A	$I_T(\text{rms})$	110
Ave. forward current, A	$I_T(\text{av})$	70
One-half cycle surge current ^① , A	I_{TSM}	1200
I^2t for fusing (for times ≥ 8.3 ms) A ² sec.	I^2t	6000
Forward voltage drop at $I_{TM} = 500\text{A}$ and $T_J = 25^\circ\text{C}$, V	V_{TM}	3.5
Min. repetitive di/dt ^{①②③} , A/ μ sec	di/dt	100

Switching

($T_J = 25^\circ\text{C}$)

	Symbol	
Max. turn-off time, $I_T = 50\text{A}$, $T_J = 125^\circ\text{C}$, $di/dt = 5$ A/ μ sec, reapplied $dv/dt =$ $20\text{V}/\mu\text{sec}$ linear to $0.8 V_{DRM}$, μsec ^{①②}	t_q	10 to 50
Typ. turn-on-time, $I_T = 100\text{A}$ $V_D = 100\text{V}$ ^③ , μsec	t_{on}	3.5
Min. critical dv/dt , exponential to V_{DRM} , $T_J = 125^\circ\text{C}$, V/ μsec ^{②③}	dv/dt	200
Min. di/dt non-repetitive, A/ μsec ^{①②③}	di/dt	800

Gate

**Maximum Parameters
($T_J = 25^\circ\text{C}$)**

	Symbol	
Gate current to trigger at $V_D = 12\text{V}$, mA	I_{GT}	150
Gate voltage to trigger at $V_D = 12\text{V}$, V	V_{GT}	3
Non-triggering gate voltage, $T_J = 125^\circ\text{C}$, and rated V_{DRM} , V	V_{GDM}	0.15
Peak forward gate current, A	I_{GTM}	4
Peak reverse gate voltage, V	V_{GRM}	5
Peak gate power, Watts	P_{GM}	16
Average gate power, Watts	$P_{G(av)}$	3

Thermal and Mechanical

	Symbol	
Min., Max. oper. junction temp., $^\circ\text{C}$	T_J	-40 to +125
Min., Max. storage temp., $^\circ\text{C}$	T_{stg}	-40 to +150
Max. mounting torque, in lb. ^①		130
Max. Thermal resistance ^①		
Junction to case, $^\circ\text{C}/\text{Watt}$	$R_{\theta JC}$.28
Case to sink, lubricated, $^\circ\text{C}/\text{Watt}$	$R_{\theta CS}$.12

- ① Consult recommended mounting procedures.
- ② Applies for zero or negative gate bias.
- ③ Per JEDEC RS-397, 5.2.2.1.
- ④ With recommended gate drive.
- ⑤ Higher dv/dt ratings available, consult factory.
- ⑥ Per JEDEC standard RS-397, 5.2.2.6.
- ⑦ For operation with antiparallel diode, consult factory.

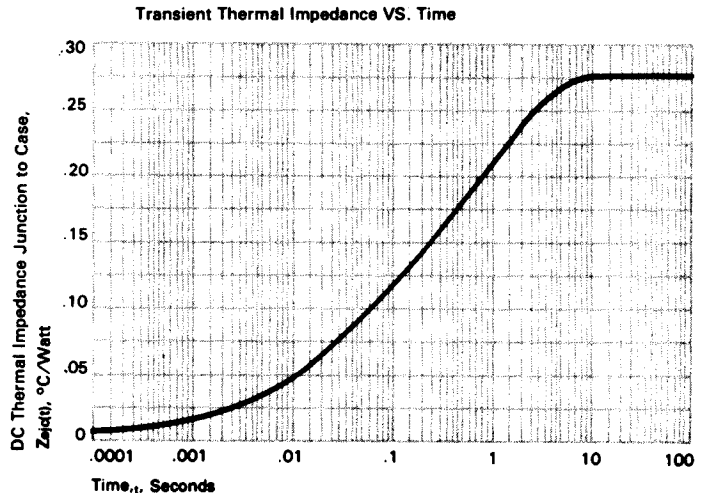
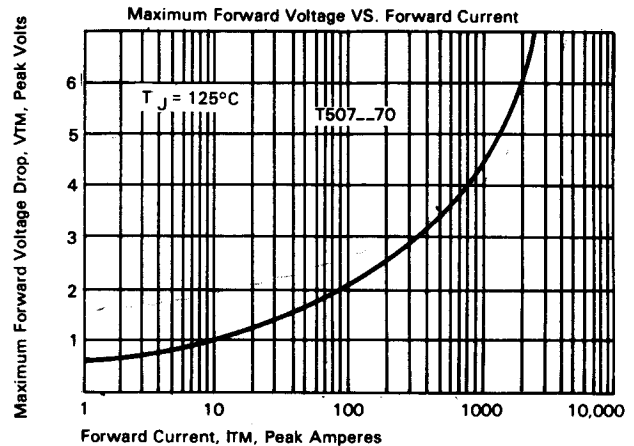

FAST SWITCHING THYRISTORS

Fast Switching SCR T507_70

70A Avg.
(110 RMS)
Up to 1400 Volts
10-50 μ s

Sinusoidal Current Data



ENERGY PER PULSE FOR SINUSOIDAL PULSES

Trapezoidal Wave Current Data

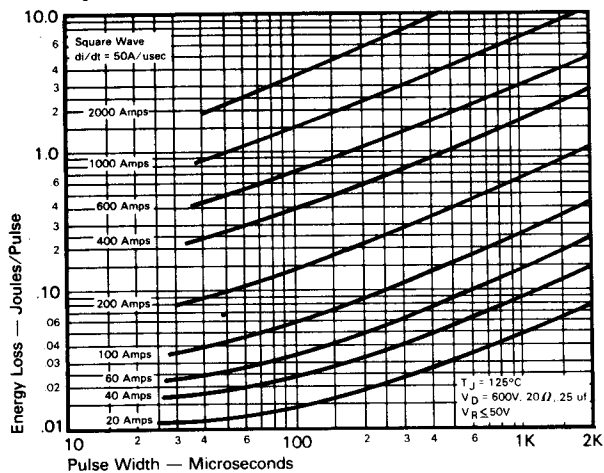

ENERGY PER PULSE FOR TRAPEZOIDAL PULSES
($di/dt = 50\text{A/usec}$)

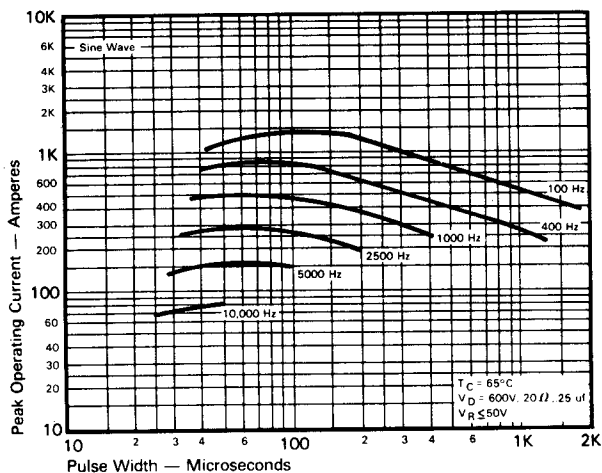

MAXIMUM ALLOWABLE PEAK ON-STATE CURRENT
vs. PULSE WIDTH ($T_C = 65^\circ\text{C}$)

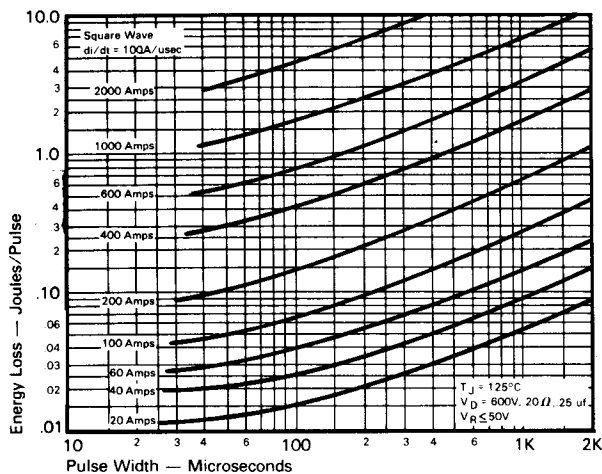

ENERGY PER PULSE FOR TRAPEZOIDAL PULSES
($di/dt = 100\text{A/usec}$)



MAXIMUM ALLOWABLE PEAK ON-STATE CURRENT
vs. PULSE WIDTH ($T_C = 90^\circ\text{C}$)

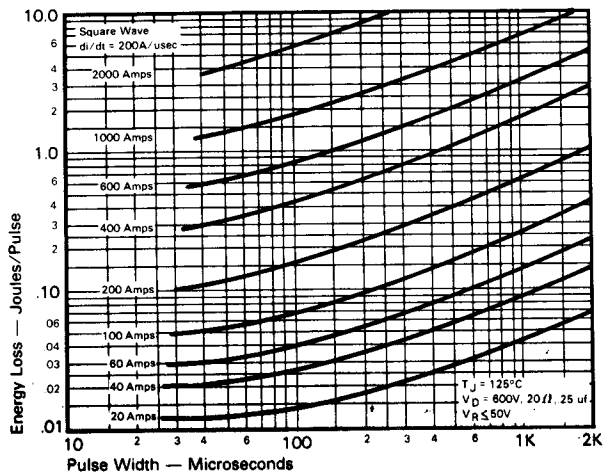

ENERGY PER PULSE FOR TRAPEZOIDAL PULSES
($di/dt = 200\text{A/usec}$)

70A Avg.
(110 RMS)
Up to 1400 Volts
10-50 μ s

Fast Switching
SCR
T507_70

Trapezoidal Wave Current Data
($T_C = 65^\circ\text{C}$)

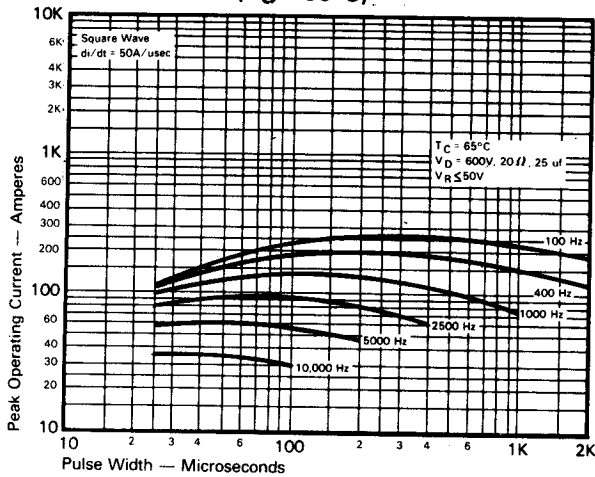

MAXIMUM ALLOWABLE PEAK ON-STATE CURRENT vs. PULSE WIDTH ($di/dt = 50A/usec$)

Trapezoidal Wave Current Data
($T_C = 90^\circ\text{C}$)

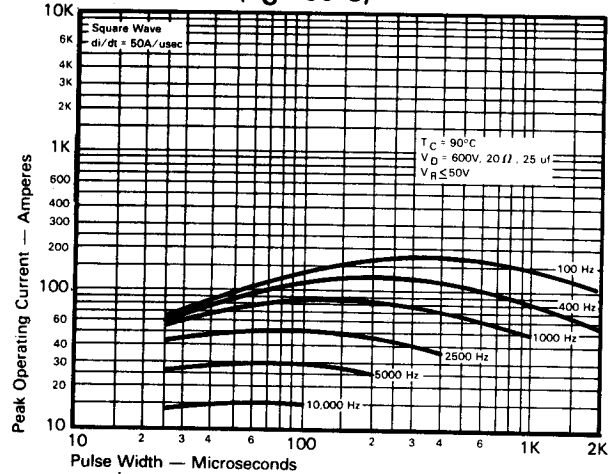

MAXIMUM ALLOWABLE PEAK ON-STATE CURRENT vs. PULSE WIDTH ($di/dt = 50A/usec$)

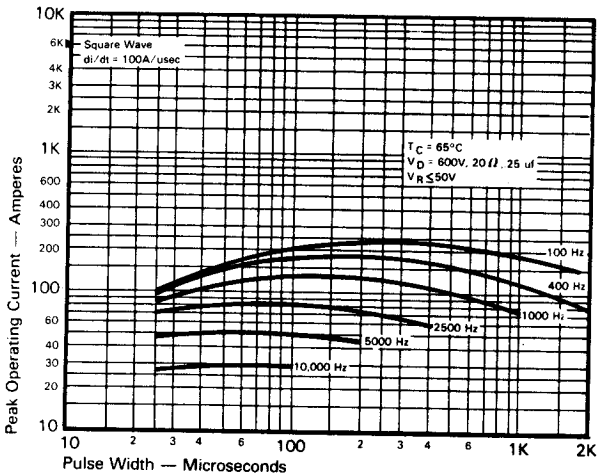

MAXIMUM ALLOWABLE PEAK ON-STATE CURRENT vs. PULSE WIDTH ($di/dt = 100A/usec$)

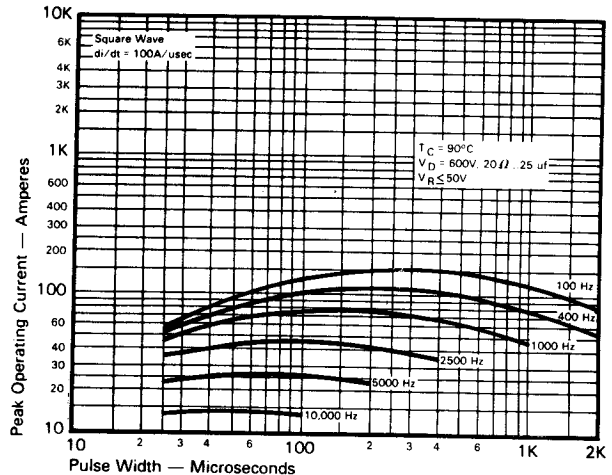

MAXIMUM ALLOWABLE PEAK ON-STATE CURRENT vs. PULSE WIDTH ($di/dt = 100A/usec$)

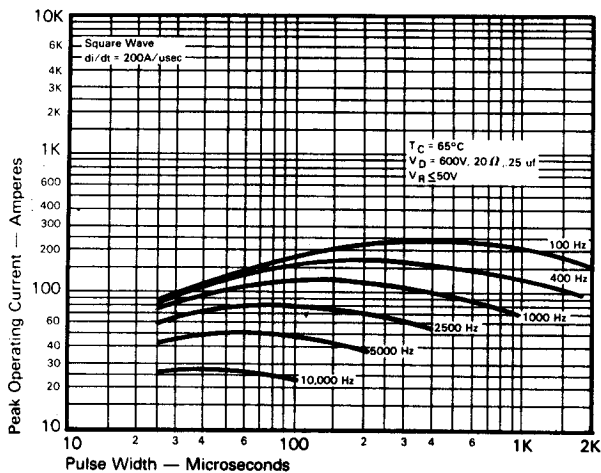

MAXIMUM ALLOWABLE PEAK ON-STATE CURRENT vs. PULSE WIDTH ($di/dt = 200A/usec$)

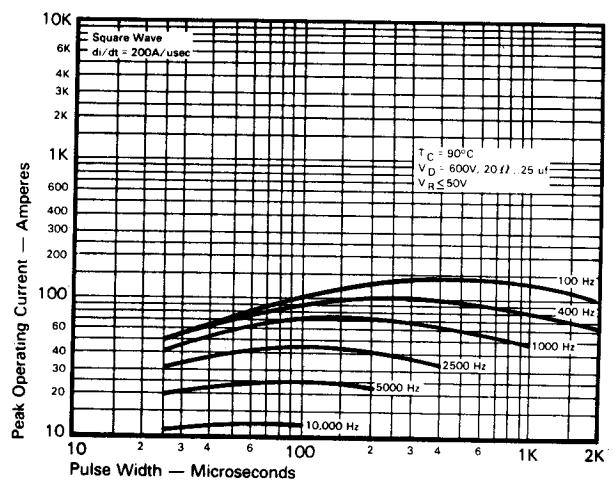

MAXIMUM ALLOWABLE PEAK ON-STATE CURRENT vs. PULSE WIDTH ($di/dt = 200A/usec$)

FAST SWITCHING THYRISTORS



CASE NUMBER T50
 NOMINAL DIMENSIONS

STRIKE DISTANCE = .44 INCH / 11.2 MM MIN.
 CREEPAGE DISTANCE = .44 INCH / 11.2 MM MIN.

SYM.	A	B	C	D	E	F	G	H	J	K
INCHES	.81	.34	.98	1.58	.89	6.12	.48	.266	7.44	.146
MM	20.6	8.6	24.9	40.1	22.6	155.4	12.2	6.76	189.0	3.71

ALL DIMENSIONS ARE REFERENCE