

Fast Switching SCR T507_80

80A Avg.
(125 RMS)
Up to 1400 Volts
10-50 μ s

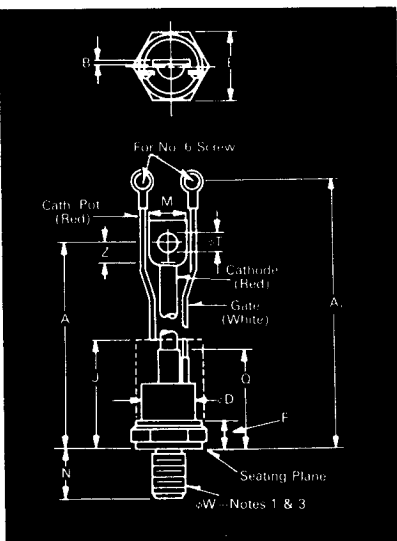

Conforms to TO-94 Outline

Symbol	Inches		Millimeters	
	Min.	Max.	Min.	Max.
A	5.775	6.265	146.69	159.13
A ₁	6.850	7.500	173.99	190.50
B	.055	.075	1.40	1.91
φD	.860	1.000	21.84	25.40
E	1.031	1.063	26.19	27.00
F	.255	.400	6.48	10.16
J	2.50		63.50	
M	.437	.650	11.10	16.51
N	.796	.827	20.24	21.01
Q		1.675		42.55
φT	.260	.291	6.60	7.39
Z	.250		6.35	
φW	½-20 UNF-2A			

Creep & Strike Distance.

T500---50 in. min. (12.85 mm).

(In accordance with NEMA standards.)

Finish—Nickel Plate.

Approx. Weight—5 oz. (142 g).

- Complete threads to extend to within 2½ threads of seating plane.
- Angular orientation of terminals is undefined.
- Pitch diameter of ½-20 UNF-2A (coated) threads (ASA B1.1-1960).
- Dimension "J" denotes seated height with leads bent at right angles.

*for 10 μ sec turn-off, consult factory

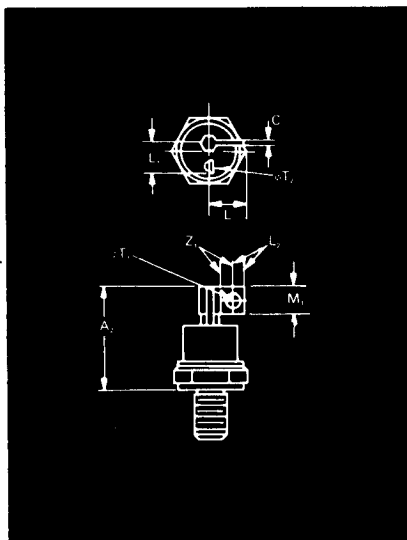

Conforms to TO-83 Outline

Symbol	Inches		Millimeters	
	Min.	Max.	Min.	Max.
A ₂		1.810		45.97
C	.070	.110	1.78	2.79
L		.650		16.51
L ₁	.420	.520	10.67	13.21
L ₂	.180		4.57	
M ₁	.360	.470	9.14	11.94
φT ₁	.190	.235	4.83	5.97
φT ₂	.060	.080	1.52	2.03
Z ₁	.180		4.57	
φW	½-20 UNF-2A			

Approx. Weight—4 oz. (114 g).

- Basic dimensions of TO-94 and TO-83 are same except as noted.

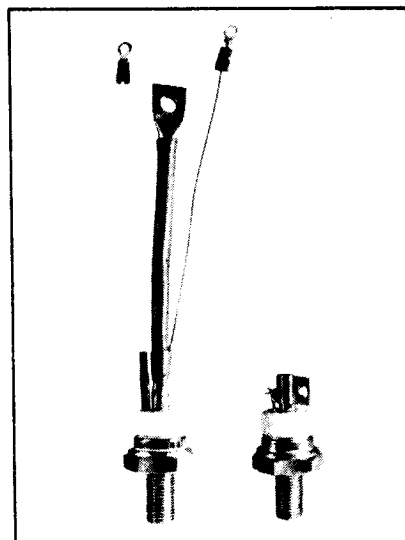

Features:

- Center fired di/damic
- High di/dt with soft gate control
- High frequency operation
- Sinusoidal waveform operation to 20 KHz
- Rectangular waveform operation to 20 KHz
- Low dynamic forward voltage drop
- Low switching losses at high frequency
- Lifetime Guarantee

Applications:

- Inverters for UPS
- Induction Heating
- AC Motor Control
- Switching power supplies
- Cycloconverters
- Choppers
- Crowbars

Ordering Information

Type	Voltage		Current		Turn-off		Gate-current		Leads	
	V _{DRM} and V _{RRM} (V)	Code	I _{T(av)} (A)	Code	t _q (μsec)	Code	I _{GT} (ma)	Code	Case	Code
T507	100	01	80	80	10	8	150	4	TO-94	AQ
	200	02			15	7				
	300	03			20	6				
	400	04			25	5				
	500	05			30	4				
	600	06			40	3				
	700	07			50	2				
	800	08			10	C				
	900	09								
	1000	10								
	1100	11								
	1200	12								
	1400	*14								

Example

Obtain optimum device performance for your application by selecting proper Order Code.

Type T 507 rated at 80 A average with V_{DRM} = 1000V, I_{GT} = 150 ma, t_q = 30 μ sec max. and flex leads—order as:

Type	Voltage	Current	Turn Off	Gate Current	Leads
T 5 0 7	1 0	8 0	5	4	A Q

**80A Avg.
(125 RMS)
Up to 1400 Volts
10-50 μ s**

**Fast Switching
SCR
T507_80**

Voltage

Blocking State Maximums @ ($T_J = 125^\circ\text{C}$)

Symbol	100	200	300	400	500	600	700	800	900	1000	1100	1200	1400
Repetitive peak forward blocking voltage, V ... V_{DRM}	100	200	300	400	500	600	700	800	900	1000	1100	1200	1400
Repetitive peak reverse voltage, V ... V_{RRM}	100	200	300	400	500	600	700	800	900	1000	1100	1200	1400
Non-repetitive transient peak reverse voltage, $t \leq 5.0$ msec, V ... V_{RSM}	200	300	400	500	600	700	800	900	1000	1100	1200	1300	1500
Forward leakage current, mA peak ... I_{DRM}	←----- 15 ----->												
Reverse leakage current, mA peak ... I_{RRM}	←----- 15 ----->												

Current

Conducting State Maximums
($T_J = 125^\circ\text{C}$)

Symbol	T507_80
RMS forward current, A ... $I_T(\text{rms})$	125
Ave. forward current, A ... $I_T(\text{av})$	80
One-half cycle surge current ^③ , A ... I_{TSM}	1400
I^2t for fusing (for times ≥ 8.3 ms) A^2 sec. ... I^2t	8150
Forward voltage drop at $I_{TM} = 500A$ and $T_J = 25^\circ\text{C}$, V ... V_{TM}	3.2
Min. repetitive di/dt ^{①②④} , A/ μ sec ... di/dt	150

Switching

($T_J = 25^\circ\text{C}$)

Symbol	
Max. turn-off time, $I_T = 50A$, $T_J = 125^\circ\text{C}$, $di/dt = 5$ A/ μ sec, reapplied $dv/dt = 20V/\mu$ sec linear to $0.8 V_{DRM}$, μ sec ^{②④} ... t_q	10 to 50
Typ. turn-on time, $I_T = 100A$, $V_D = 100V$, μ sec ... t_{on}	3.5
Min. critical dv/dt , exponential to V_{DRM} , $T_J = 125^\circ\text{C}$, V/ μ sec ^{②④} ... dv/dt	200
Min. di/dt non-repetitive, A/ μ sec ^{①②④} ... di/dt	800

Gate

Maximum Parameters
($T_J = 25^\circ\text{C}$)

Symbol	
Gate current to trigger at $V_D = 12V$, mA ... I_{GT}	150
Gate voltage to trigger at $V_D = 12V$, V ... V_{GT}	3
Non-triggering gate voltage, $T_J = 125^\circ\text{C}$, and rated V_{DRM} , V ... V_{GDM}	0.15
Peak forward gate current, A ... I_{GTM}	4
Peak reverse gate voltage, V ... V_{GRM}	5
Peak gate power, Watts ... P_{GM}	16
Average gate power, Watts ... $P_{G(av)}$	3

Thermal and Mechanical

Symbol	
Min., Max. oper. junction temp., $^\circ\text{C}$... T_J	-40 to +125
Min., Max. storage temp., $^\circ\text{C}$... T_{stg}	-40 to +150
Max. mounting torque, in lb. \odot ...	130
Max. Thermal resistance \odot	
Junction to case, $^\circ\text{C}/\text{Watt}$... $R_{\theta JC}$.28
Case to sink, lubricated, $^\circ\text{C}/\text{Watt}$... $R_{\theta CS}$.12

- ① Consult recommended mounting procedures.
- ② Applies for zero or negative gate bias.
- ③ Per JEDEC RS-397, 5.2.2.1.
- ④ With recommended gate drive.
- ⑤ Higher dv/dt ratings available, consult factory.
- ⑥ Per JEDEC standard RS-397, 5.2.2.6.
- ⑦ For operation with antiparallel diode, consult factory.

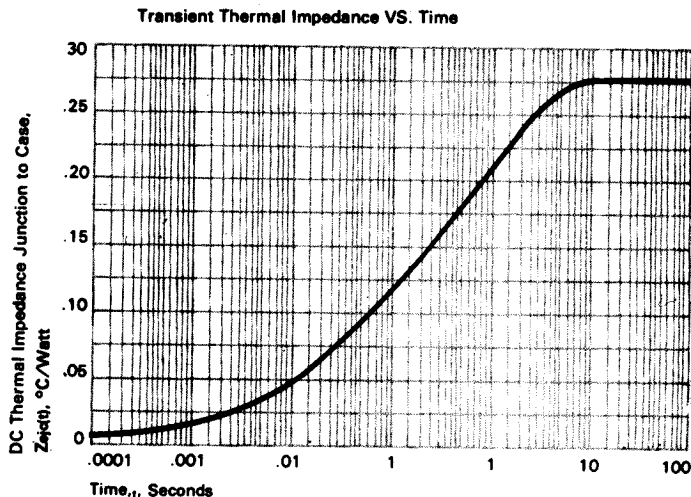
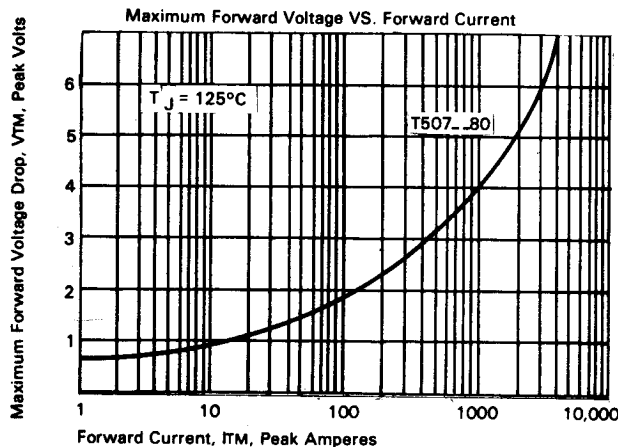

FAST SWITCHING THYRISTORS

Fast Switching SCR T507_80

80A Avg.
(125 RMS)
Up to 1400 Volts
10-50 μ s

Sinusoidal Current Data

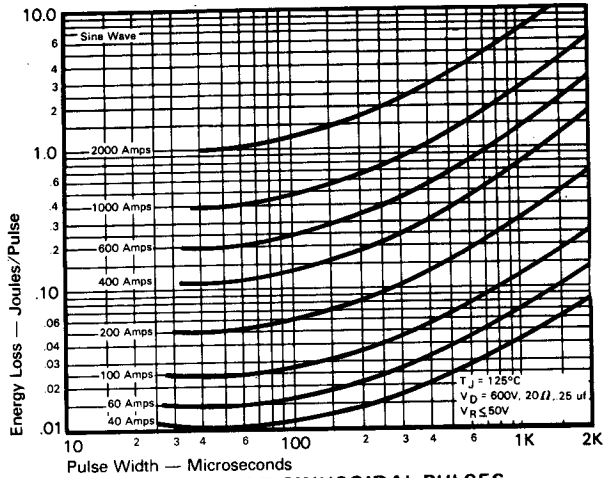

ENERGY PER PULSE FOR SINUSOIDAL PULSES

Trapezoidal Wave Current Data

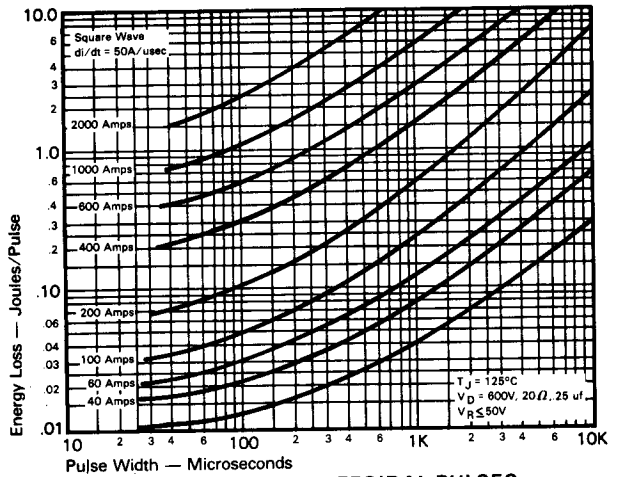

ENERGY PER PULSE FOR TRAPEZOIDAL PULSES
($di/dt = 50\text{A}/\mu\text{sec}$)

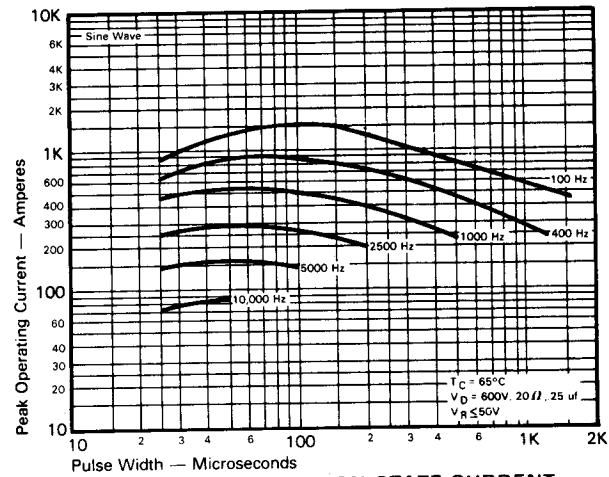

MAXIMUM ALLOWABLE PEAK ON-STATE CURRENT
vs. PULSE WIDTH ($T_C = 65^\circ\text{C}$)

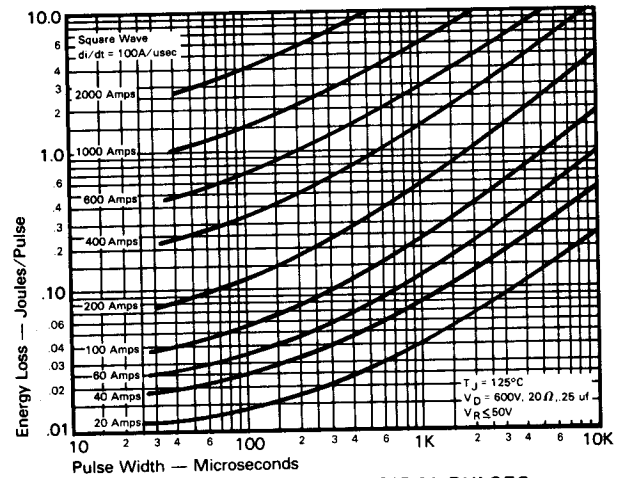

ENERGY PER PULSE FOR TRAPEZOIDAL PULSES
($di/dt = 100\text{A}/\mu\text{sec}$)

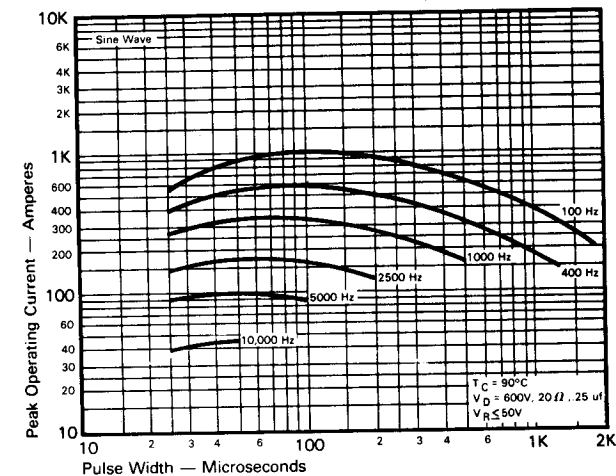

MAXIMUM ALLOWABLE PEAK ON-STATE CURRENT
vs. PULSE WIDTH ($T_C = 90^\circ\text{C}$)

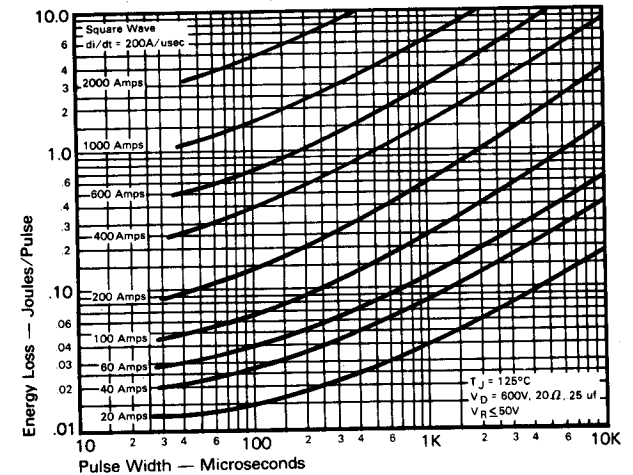

ENERGY PER PULSE FOR TRAPEZOIDAL PULSES
($di/dt = 200\text{A}/\mu\text{sec}$)

FAST SWITCHING
THYRISTORS

**80A Avg.
(125 RMS)
Up to 1400 Volts
10-50 μ s**

**Fast Switching
SCR
T507_80**

**Trapezoidal Wave Current Data
($T_C = 65^\circ\text{C}$)**

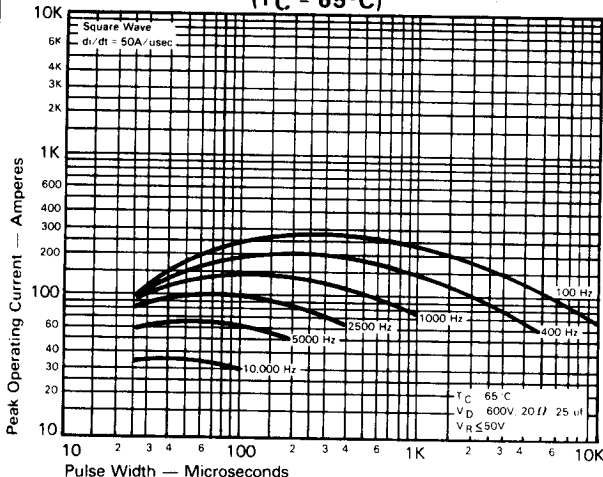

MAXIMUM ALLOWABLE PEAK ON-STATE CURRENT vs. PULSE WIDTH ($di/dt = 50\text{A/usec}$)

**Trapezoidal Wave Current Data
($T_C = 90^\circ\text{C}$)**

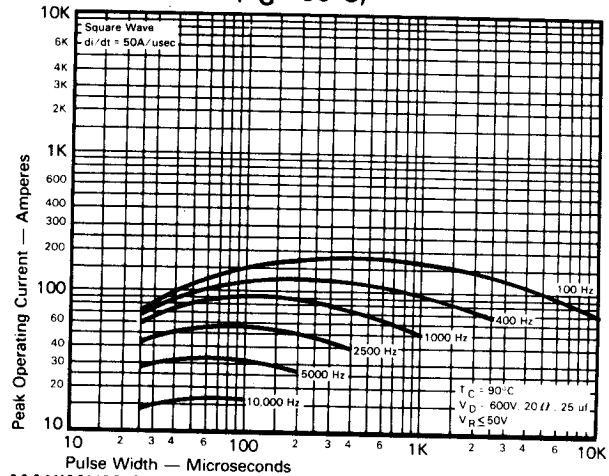

MAXIMUM ALLOWABLE PEAK ON-STATE CURRENT vs. PULSE WIDTH ($di/dt = 50\text{A/usec}$)

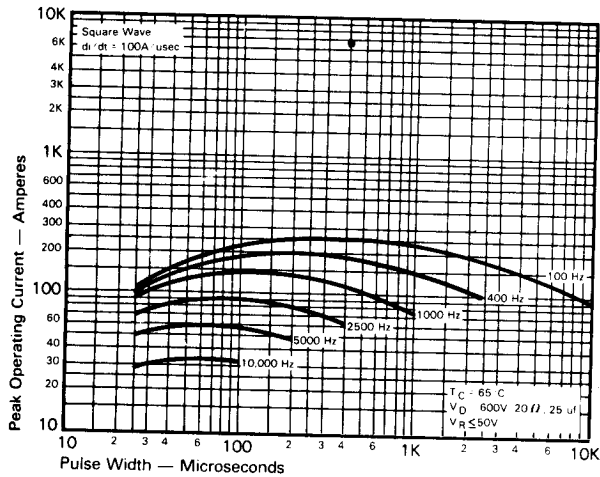

MAXIMUM ALLOWABLE PEAK ON-STATE CURRENT vs. PULSE WIDTH ($di/dt = 100\text{A/usec}$)

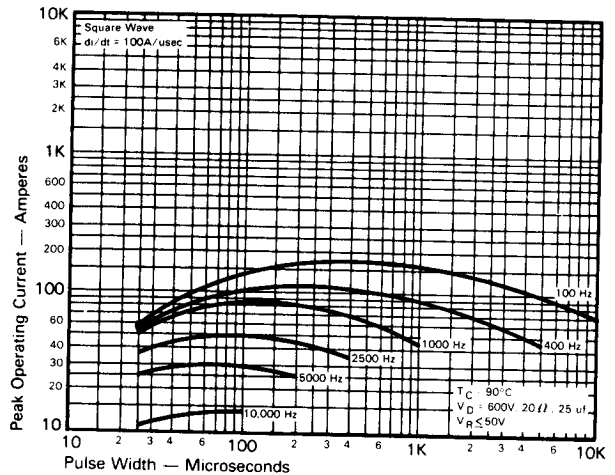

MAXIMUM ALLOWABLE PEAK ON-STATE CURRENT vs. PULSE WIDTH ($di/dt = 100\text{A/usec}$)

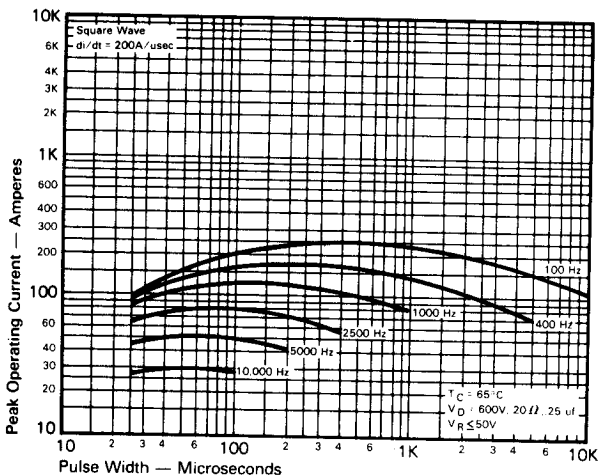

MAXIMUM ALLOWABLE PEAK ON-STATE CURRENT vs. PULSE WIDTH ($di/dt = 200\text{A/usec}$)

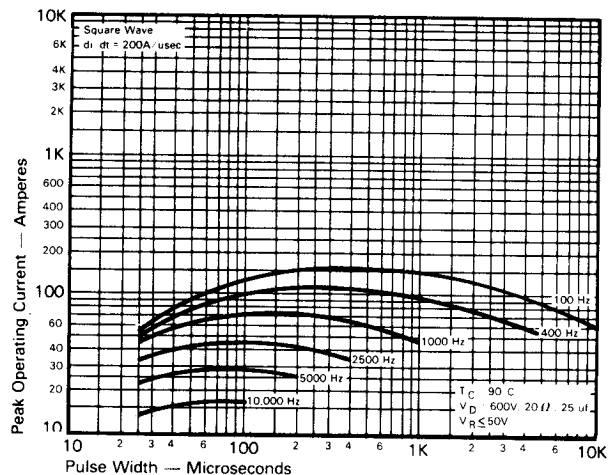

MAXIMUM ALLOWABLE PEAK ON-STATE CURRENT vs. PULSE WIDTH ($di/dt = 200\text{A/usec}$)

FAST SWITCHING THYRISTORS



CASE NUMBER T50
 NOMINAL DIMENSIONS

STRIKE DISTANCE = .44 INCH / 11.2 MM MIN.
 CREEPAGE DISTANCE = .44 INCH / 11.2 MM MIN.

SYM.	A	B	C	D	E	F	G	H	J	K
INCHES	.81	.34	.98	1.58	.89	6.12	.48	.266	7.44	.146
MM	20.6	8.6	24.9	40.1	22.6	155.4	12.2	6.76	189.0	3.71

ALL DIMENSIONS ARE REFERENCE