

# Fast Switching SCR T507\_80

80A Avg.  
(125 RMS)  
Up to 1400 Volts  
10-50  $\mu$ s

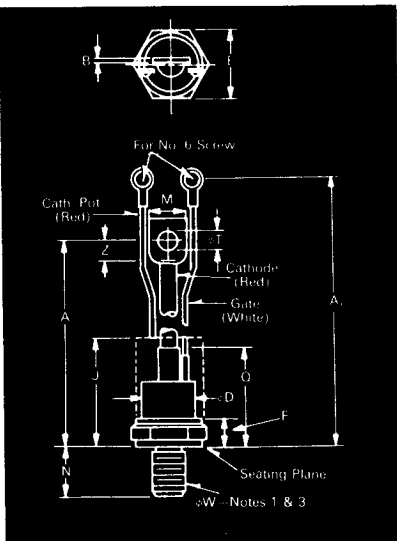

Conforms to TO-94 Outline

Symbol	Inches		Millimeters	
	Min.	Max.	Min.	Max.
A	5.775	6.265	146.69	159.13
A <sub>1</sub>	6.850	7.500	173.99	190.50
B	.055	.075	1.40	1.91
φD	.860	1.000	21.84	25.40
E	1.031	1.063	26.19	27.00
F	.255	.400	6.48	10.16
J	2.50		63.50	
M	.437	.650	11.10	16.51
N	.796	.827	20.24	21.01
Q		1.675		42.55
φT	.260	.291	6.60	7.39
Z	.250		6.35	
φW	½-20 UNF-2A			

Creep & Strike Distance.

T500---50 in. min. (12.85 mm).

(In accordance with NEMA standards.)

Finish—Nickel Plate.

Approx. Weight—5 oz. (142 g).

1. Complete threads to extend to within 2½ threads of seating plane.
2. Angular orientation of terminals is undefined.
3. Pitch diameter of ½-20 UNF-2A (coated) threads (ASA B1.1-1960).
4. Dimension "J" denotes seated height with leads bent at right angles.

\*for 10  $\mu$ sec turn-off, consult factory

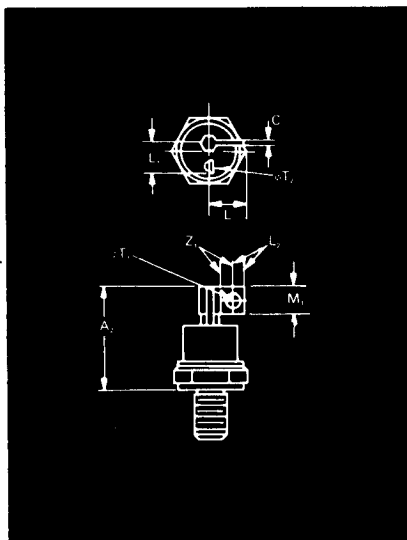

Conforms to TO-83 Outline

Symbol	Inches		Millimeters	
	Min.	Max.	Min.	Max.
A <sub>2</sub>		1.810		45.97
C	.070	.110	1.78	2.79
L		.650		16.51
L <sub>1</sub>	.420	.520	10.67	13.21
L <sub>2</sub>	.180		4.57	
M <sub>1</sub>	.360	.470	9.14	11.94
φT <sub>1</sub>	.190	.235	4.83	5.97
φT <sub>2</sub>	.060	.080	1.52	2.03
Z <sub>1</sub>	.180		4.57	
φW	½-20 UNF-2A			

Approx. Weight—4 oz. (114 g).

1. Basic dimensions of TO-94 and TO-83 are same except as noted.

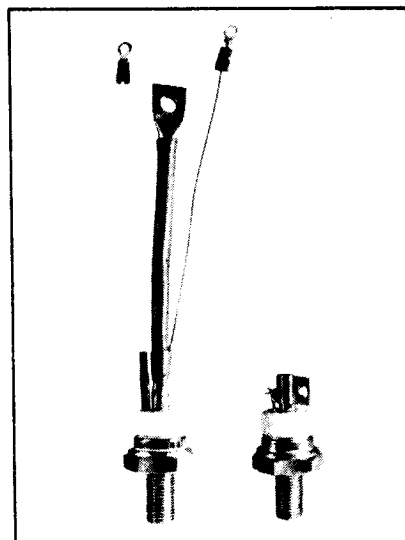

### Features:

- Center fired di/damic
- High di/dt with soft gate control
- High frequency operation
- Sinusoidal waveform operation to 20 KHz
- Rectangular waveform operation to 20 KHz
- Low dynamic forward voltage drop
- Low switching losses at high frequency
- Lifetime Guarantee

### Applications:

- Inverters for UPS
- Induction Heating
- AC Motor Control
- Switching power supplies
- Cycloconverters
- Choppers
- Crowbars

### Ordering Information

Type	Voltage		Current		Turn-off		Gate-current		Leads	
	V <sub>DRM</sub> and V <sub>RRM</sub> (V)	Code	I <sub>T(av)</sub> (A)	Code	t <sub>q</sub> (μsec)	Code	I <sub>GT</sub> (ma)	Code	Case	Code
T507	100	01	80	80	10	8	150	4	TO-94	AQ
	200	02			15	7				
	300	03			20	6				
	400	04			25	5				
	500	05			30	4				
	600	06			40	3				
	700	07			50	2				
	800	08			10	C				
	900	09								
	1000	10								
	1100	11								
	1200	12								
	1400	*14								

### Example

Obtain optimum device performance for your application by selecting proper Order Code.

Type T 507 rated at 80 A average with V<sub>DRM</sub> = 1000V, I<sub>GT</sub> = 150 ma, t<sub>q</sub> = 30  $\mu$ sec max. and flex leads—order as:

Type	Voltage	Current	Turn Off	Gate Current	Leads
T 5 0 7	1 0	8 0	5	4	A Q

**80A Avg.  
(125 RMS)  
Up to 1400 Volts  
10-50  $\mu$ s**

**Fast Switching  
SCR  
T507\_80**

**Voltage**

**Blocking State Maximums** @ ( $T_J = 125^\circ\text{C}$ )

Symbol	100	200	300	400	500	600	700	800	900	1000	1100	1200	1400
Repetitive peak forward blocking voltage, $V_{DRM}$	100	200	300	400	500	600	700	800	900	1000	1100	1200	1400
Repetitive peak reverse voltage, $V_{RRM}$	100	200	300	400	500	600	700	800	900	1000	1100	1200	1400
Non-repetitive transient peak reverse voltage, $V_{RSM}$ $t \leq 5.0$ msec	200	300	400	500	600	700	800	900	1000	1100	1200	1300	1500
Forward leakage current, mA peak $I_{DRM}$	←----- 15 ----->												
Reverse leakage current, mA peak $I_{RRM}$	←----- 15 ----->												

**Current**

**Conducting State Maximums**  
( $T_J = 125^\circ\text{C}$ )

Symbol	T507_80
RMS forward current, A $I_T(\text{rms})$	125
Ave. forward current, A $I_T(\text{av})$	80
One-half cycle surge current <sup>③</sup> , A $I_{TSM}$	1400
$I^2t$ for fusing (for times $\geq 8.3$ ms) A <sup>2</sup> sec $I^2t$	8150
Forward voltage drop at $I_{TM} = 500\text{A}$ and $T_J = 25^\circ\text{C}$ , V $V_{TM}$	3.2
Min. repetitive $di/dt$ <sup>④⑤</sup> , A/ $\mu$ sec $di/dt$	150

**Switching**

( $T_J = 25^\circ\text{C}$ )

Symbol	
Max. turn-off time, $I_T = 50\text{A}$ , $T_J = 125^\circ\text{C}$ , $di/dt = 5$ A/ $\mu$ sec, reapplied $dv/dt =$ $20\text{V}/\mu\text{sec}$ linear to $0.8 V_{DRM}$ , $\mu\text{sec}$ <sup>⑥⑦</sup> $t_q$	10 to 50
Typ. turn-on time, $I_T = 100\text{A}$ , $V_D = 100\text{V}$ , $\mu\text{sec}$ $t_{on}$	3.5
Min. critical $dv/dt$ , exponential to $V_{DRM}$ , $T_J = 125^\circ\text{C}$ , V/ $\mu\text{sec}$ <sup>⑧</sup> $dv/dt$	200
Min. $di/dt$ non-repetitive, A/ $\mu\text{sec}$ <sup>④⑤</sup> $di/dt$	800

**Gate**

**Maximum Parameters**  
( $T_J = 25^\circ\text{C}$ )

Symbol	
Gate current to trigger at $V_D = 12\text{V}$ , mA $I_{GT}$	150
Gate voltage to trigger at $V_D = 12\text{V}$ , V $V_{GT}$	3
Non-triggering gate voltage, $T_J = 125^\circ\text{C}$ , and rated $V_{DRM}$ , V $V_{GDM}$	0.15
Peak forward gate current, A $I_{GTM}$	4
Peak reverse gate voltage, V $V_{GRM}$	5
Peak gate power, Watts $P_{GM}$	16
Average gate power, Watts $P_{G(av)}$	3

**Thermal and Mechanical**

Symbol	
Min., Max. oper. junction temp., $^\circ\text{C}$ $T_J$	-40 to +125
Min., Max. storage temp., $^\circ\text{C}$ $T_{stg}$	-40 to +150
Max. mounting torque, in lb. $\text{①}$	130
Max. Thermal resistance $\text{①}$	
Junction to case, $^\circ\text{C}/\text{Watt}$ $R_{\theta JC}$	.28
Case to sink, lubricated, $^\circ\text{C}/\text{Watt}$ $R_{\theta CS}$	.12

- ① Consult recommended mounting procedures.
- ② Applies for zero or negative gate bias.
- ③ Per JEDEC RS-397, 5.2.2.1.
- ④ With recommended gate drive.
- ⑤ Higher  $dv/dt$  ratings available, consult factory.
- ⑥ Per JEDEC standard RS-397, 5.2.2.6.
- ⑦ For operation with antiparallel diode, consult factory.

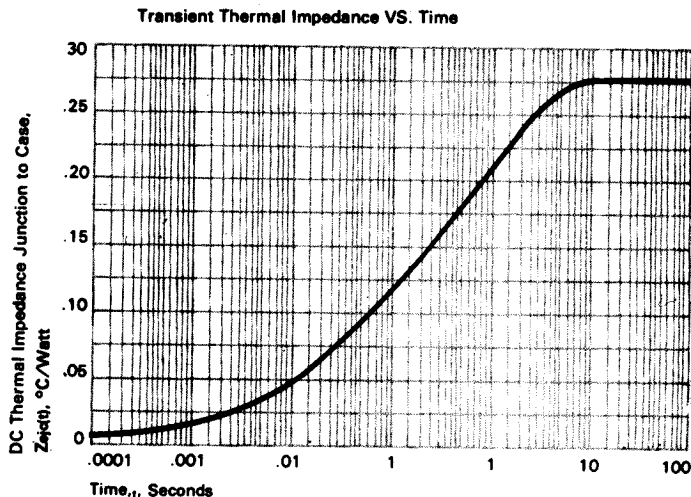
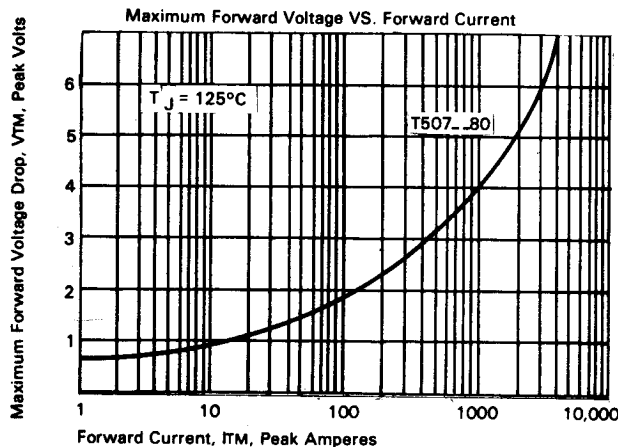

FAST SWITCHING THYRISTORS

# Fast Switching SCR T507\_80

80A Avg.  
(125 RMS)  
Up to 1400 Volts  
10-50  $\mu$ s

## Sinusoidal Current Data

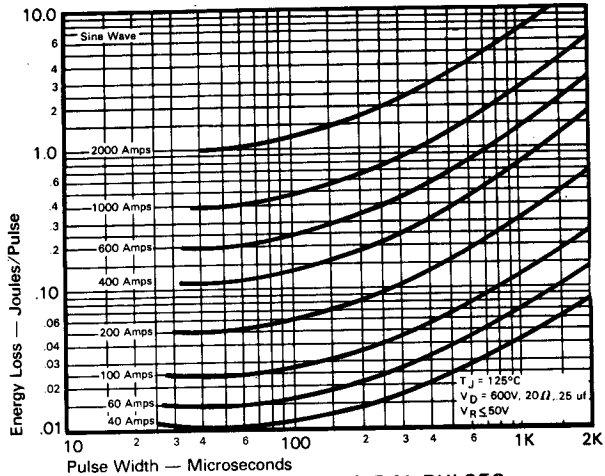

ENERGY PER PULSE FOR SINUSOIDAL PULSES

## Trapezoidal Wave Current Data

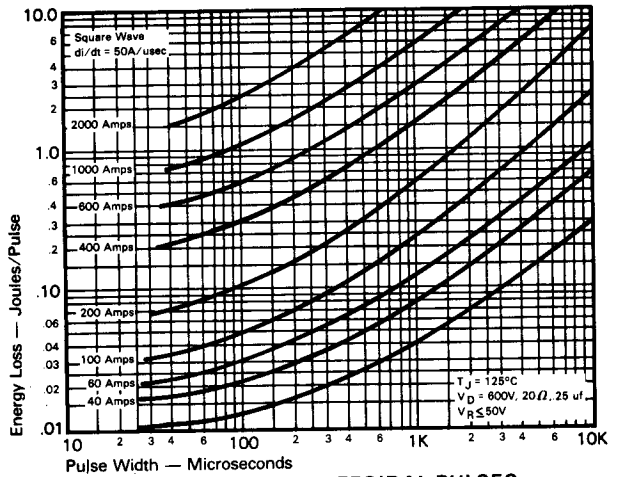

ENERGY PER PULSE FOR TRAPEZOIDAL PULSES  
( $di/dt = 50\text{A/usec}$ )

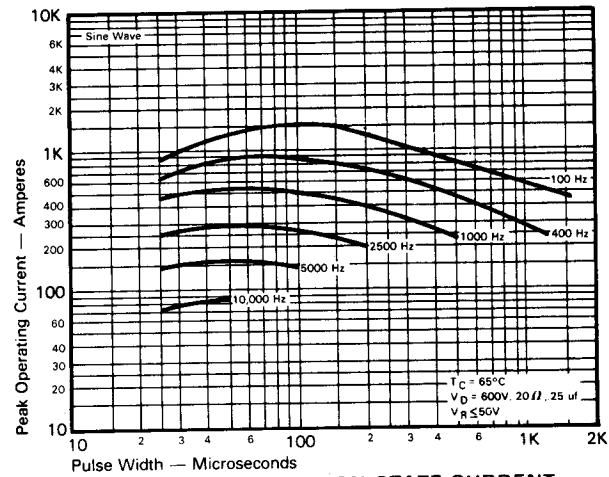

MAXIMUM ALLOWABLE PEAK ON-STATE CURRENT  
vs. PULSE WIDTH ( $T_C = 65^\circ\text{C}$ )

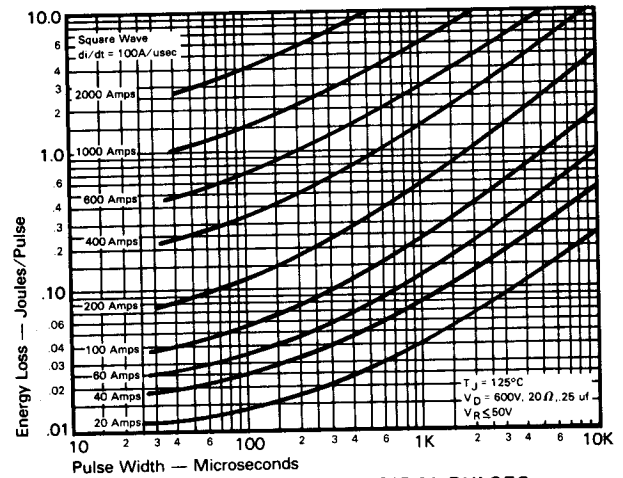

ENERGY PER PULSE FOR TRAPEZOIDAL PULSES  
( $di/dt = 100\text{A/usec}$ )

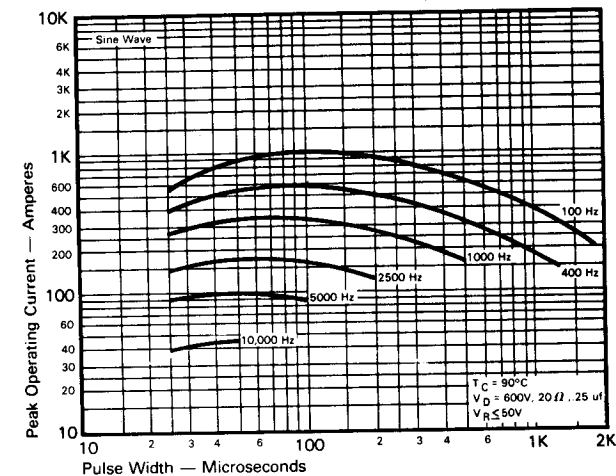

MAXIMUM ALLOWABLE PEAK ON-STATE CURRENT  
vs. PULSE WIDTH ( $T_C = 90^\circ\text{C}$ )

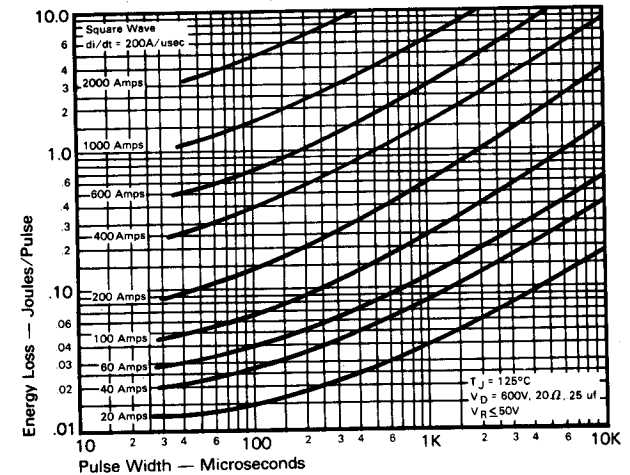

ENERGY PER PULSE FOR TRAPEZOIDAL PULSES  
( $di/dt = 200\text{A/usec}$ )

FAST SWITCHING  
THYRISTORS

**80A Avg.  
(125 RMS)  
Up to 1400 Volts  
10-50  $\mu$ s**

**Fast Switching  
SCR  
T507\_80**

**Trapezoidal Wave Current Data  
( $T_C = 65^\circ\text{C}$ )**

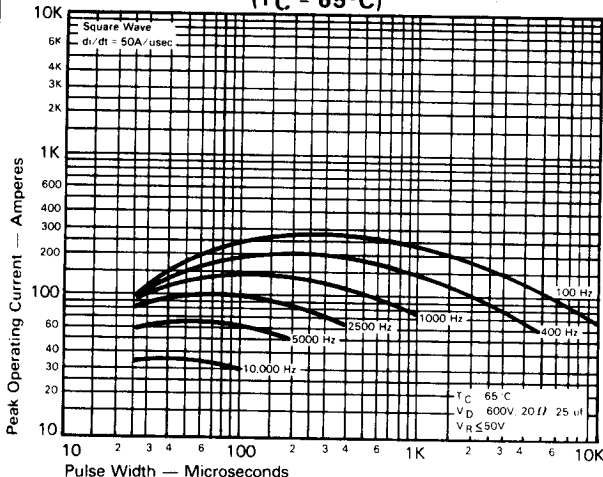

**MAXIMUM ALLOWABLE PEAK ON-STATE CURRENT vs. PULSE WIDTH ( $di/dt = 50A/usec$ )**

**Trapezoidal Wave Current Data  
( $T_C = 90^\circ\text{C}$ )**

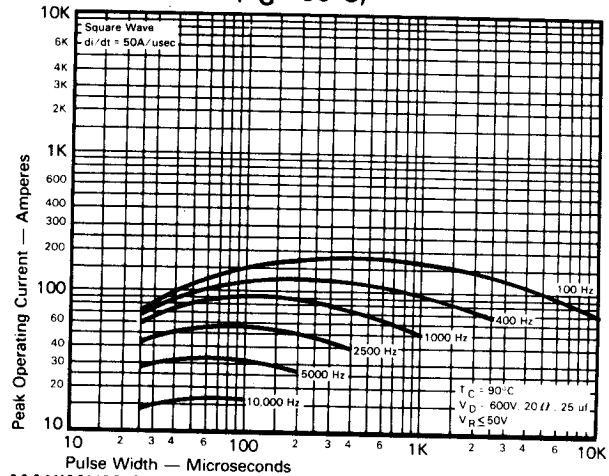

**MAXIMUM ALLOWABLE PEAK ON-STATE CURRENT vs. PULSE WIDTH ( $di/dt = 50A/usec$ )**

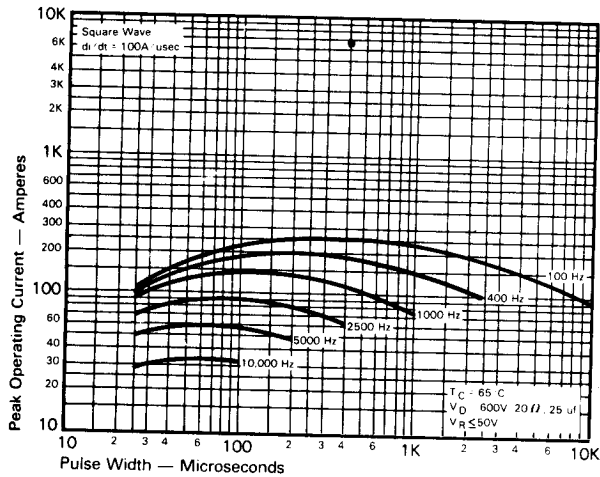

**MAXIMUM ALLOWABLE PEAK ON-STATE CURRENT vs. PULSE WIDTH ( $di/dt = 100A/usec$ )**

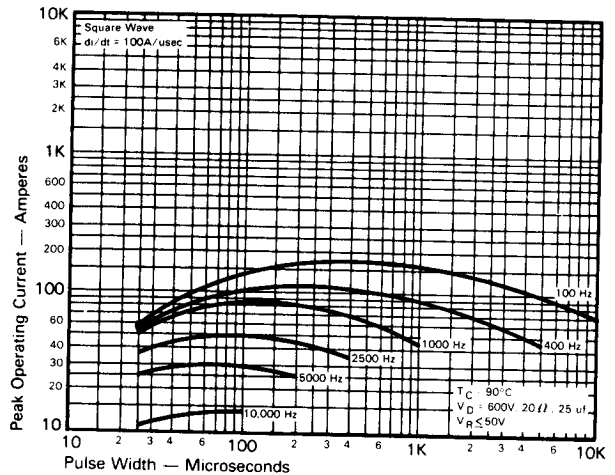

**MAXIMUM ALLOWABLE PEAK ON-STATE CURRENT vs. PULSE WIDTH ( $di/dt = 100A/usec$ )**

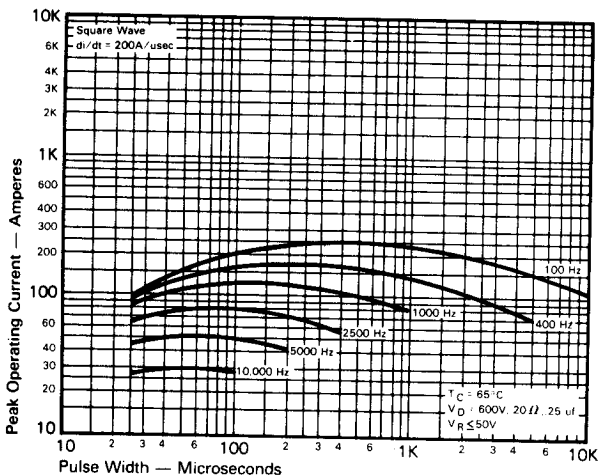

**MAXIMUM ALLOWABLE PEAK ON-STATE CURRENT vs. PULSE WIDTH ( $di/dt = 200A/usec$ )**

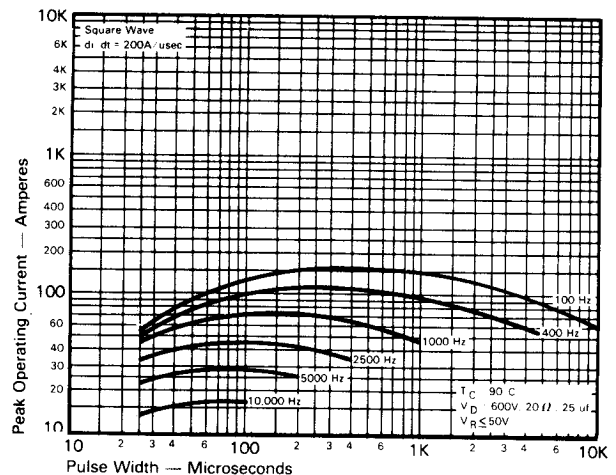

**MAXIMUM ALLOWABLE PEAK ON-STATE CURRENT vs. PULSE WIDTH ( $di/dt = 200A/usec$ )**

FAST SWITCHING THYRISTORS



CASE NUMBER T50  
 NOMINAL DIMENSIONS

STRIKE DISTANCE = .44 INCH / 11.2 MM MIN.  
 CREEPAGE DISTANCE = .44 INCH / 11.2 MM MIN.

SYM.	A	B	C	D	E	F	G	H	J	K
INCHES	.81	.34	.98	1.58	.89	6.12	.48	.266	7.44	.146
MM	20.6	8.6	24.9	40.1	22.6	155.4	12.2	6.76	189.0	3.71

ALL DIMENSIONS ARE REFERENCE