

Fast Switching SCR T507_70

70A Avg.
(110 RMS)
Up to 1400 Volts
10-50 μ s

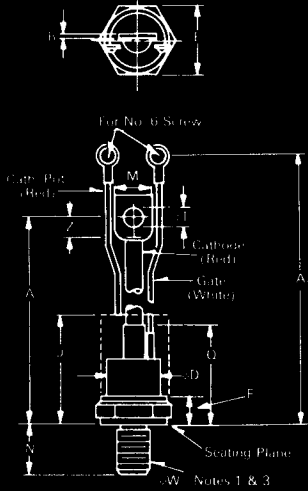

Conforms to TO-94 Outline

Symbol	Inches		Millimeters	
	Min.	Max.	Min.	Max.
A	5.775	6.265	146.69	159.13
A ₁	6.850	7.500	173.99	190.50
B	.055	.075	1.40	1.91
ϕ D	.860	1.000	21.84	25.40
E	1.031	1.063	26.19	27.00
F	.255	.400	6.48	10.16
J	2.50		63.50	
M	.437	.650	11.10	16.51
N	.796	.827	20.24	21.01
Q		1.675		42.55
ϕ T	.260	.291	6.60	7.39
Z	.250		6.35	
ϕ W	$\frac{1}{2}$ -20 UNF-2A			

- Creep & Strike Distance.
T500—.50 in. min. (12.85 mm).
(In accordance with NEMA standards.)
Finish—Nickel Plate.
Approx. Weight—5 oz. (142 g).
1. Complete threads to extend to within 2½ threads of seating plane.
2. Angular orientation of terminals is undefined.
3. Pitch diameter of $\frac{1}{2}$ -20 UNF-2A (coated) threads (ASA B1.1-1960).
4. Dimension "J" denotes seated height with leads bent at right angles.

*for 10 μ sec turn-off, consult factory

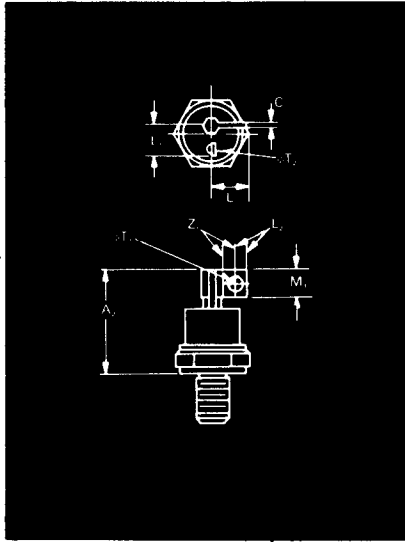

Conforms to TO-83 Outline

Symbol	Inches		Millimeters	
	Min.	Max.	Min.	Max.
A ₂		1.810		45.97
C	.070	.110	1.78	2.79
L		.650		16.51
L ₁	.420	.520	10.67	13.21
L ₂	.180		4.57	
M ₁	.360	.470	9.14	11.94
ϕ T ₁	.190	.235	4.83	5.97
ϕ T ₂	.060	.080	1.52	2.03
Z ₁	.180		4.57	
ϕ W	$\frac{1}{2}$ -20 UNF-2A			

- Approx. Weight—4 oz. (114 g).
1. Basic dimensions of TO-94 and TO-83 are same except as noted.

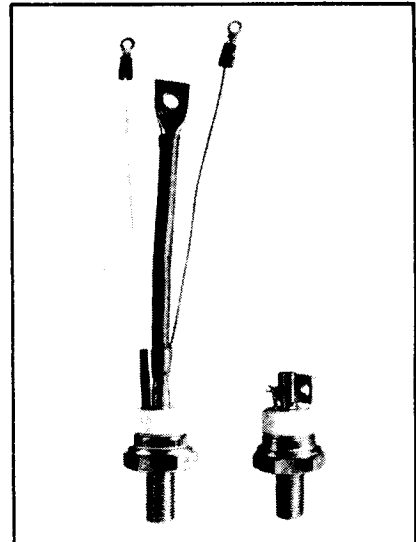

Features:

- Center fired di/damic
- High di/dt with soft gate control
- High frequency operation
- Sinusoidal waveform operation to 20 KHz
- Rectangular waveform operation to 20 KHz
- Low dynamic forward voltage drop
- Low switching losses at high frequency
- Lifetime Guarantee

Applications:

- Inverters for UPS
- Induction Heating
- AC Motor Control
- Switching power supplies
- Cycloconverters
- Choppers
- Crowbars

Ordering Information

Type	Voltage		Current		Turn-off		Gate current		Leads		
	V _{DRM} and V _{RRM} (V)	Code	I _{T(av)} (A)	Code	t _q (μ sec)	Code	I _{GT} (ma)	Code	Case	Code	
T507	100	01	70	70	10	5	150	4	TO-94	AQ	
	200	02									
	300	03									
	400	04									
	500	05								TO-83	AB
	600	06									
	700	07									
	800	08									
	900	09									
	1000	10									
	1100	11									
	1200	12									
	1400	*14									

Type	Voltage	Current	Turn Off	Gate Current	Leads
T 5 0 7 0 8 9 0 6 4 A Q					

Example

Obtain optimum device performance for your application by selecting proper Order Code.

Type T 507 rated at 70 A average with V_{DRM} = 800V.
I_{GT} = .150 ma, t_q = 20 μ sec max. and flex leads—order as:

**70A Avg.
(110 RMS)
Up to 1400 Volts
10-50 μ s**

**Fast Switching
SCR
T507__70**

Voltage

Blocking State Maximums @ (T_J = 125°C)

	Symbol	100	200	300	400	500	600	700	800	900	1000	1100	1200	1400
Repetitive peak forward blocking voltage, V	V _{DRM}	100	200	300	400	500	600	700	800	900	1000	1100	1200	1400
Repetitive peak reverse voltage, V	V _{RRM}	100	200	300	400	500	600	700	800	900	1000	1100	1200	1400
Non-repetitive transient peak reverse voltage, t ≤ 5.0 msec, V	V _{SRM}	200	300	400	500	600	700	800	900	1000	1100	1200	1300	1500
Forward leakage current, mA peak	I _{DRM}	← 15 →												
Reverse leakage current, mA peak	I _{RRM}	← 15 →												

Current

**Conducting State Maximums
(T_J = 125°C)**

	Symbol	T507__70
RMS forward current, A	I _{T(rms)}	110
Ave. forward current, A	I _{T(av)}	70
One-half cycle surge current ^① , A	I _{TSM}	1200
I ² t for fusing (for times ≥ 8.3 ms) A ² sec.	I ² t	6000
Forward voltage drop at I _{TM} = 500A and T _J = 25°C, V	V _{TM}	3.5
Min. repetitive di/dt ^{①②③} , A/ μ sec	di/dt	100

**Switching
(T_J = 25°C)**

	Symbol	
Max. turn-off time, I _T = 50A, T _J = 125°C, di _R /dt = 5 A/ μ sec, reapplied dv/dt = 20V/ μ sec linear to 0.8 V _{DRM} , μ sec ^{①②}	t _q	10 to 50
Typ. turn-on-time, I _T = 100A V _D = 100V ^③ , μ sec	t _{on}	3.5
Min. critical dv/dt, exponential to V _{DRM} , T _J = 125°C, V/ μ sec ^{②③}	dv/dt	200
Min. di/dt non-repetitive, A/ μ sec ^{①②③}	di/dt	800

Gate

**Maximum Parameters
(T_J = 25°C)**

	Symbol	
Gate current to trigger at V _D = 12V, mA	I _{GT}	150
Gate voltage to trigger at V _D = 12V, V	V _{GT}	3
Non-triggering gate voltage, T _J = 125°C, and rated V _{DRM} , V	V _{GDM}	0.15
Peak forward gate current, A	I _{GTM}	4
Peak reverse gate voltage, V	V _{GRM}	5
Peak gate power, Watts	P _{GM}	16
Average gate power, Watts	P _{G(av)}	3

Thermal and Mechanical

	Symbol	
Min., Max. oper. junction temp., °C	T _J	-40 to +125
Min., Max. storage temp., °C	T _{stg}	-40 to +150
Max. mounting torque, in lb. ^①		130
Max. Thermal resistance ^①		
Junction to case, °C/Watt	R _{θJC}	.28
Case to sink, lubricated, °C/Watt	R _{θCS}	.12

- ① Consult recommended mounting procedures.
- ② Applies for zero or negative gate bias.
- ③ Per JEDEC RS-397, 5.2.2.1.
- ④ With recommended gate drive.
- ⑤ Higher dv/dt ratings available, consult factory.
- ⑥ Per JEDEC standard RS-397, 5.2.2.6.
- ⑦ For operation with antiparallel diode, consult factory.

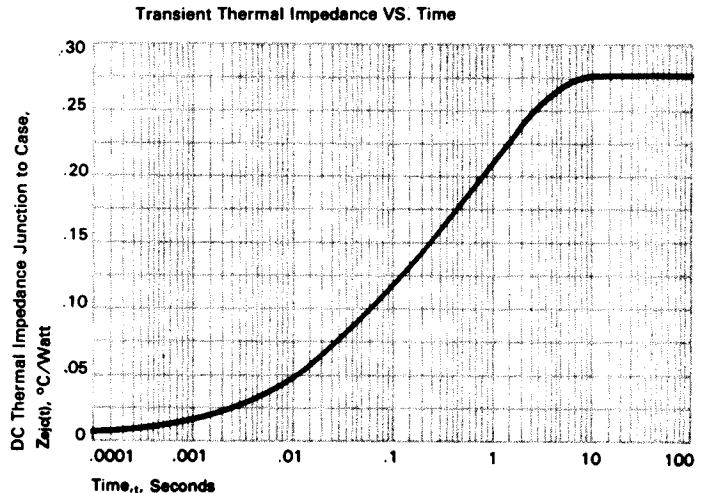
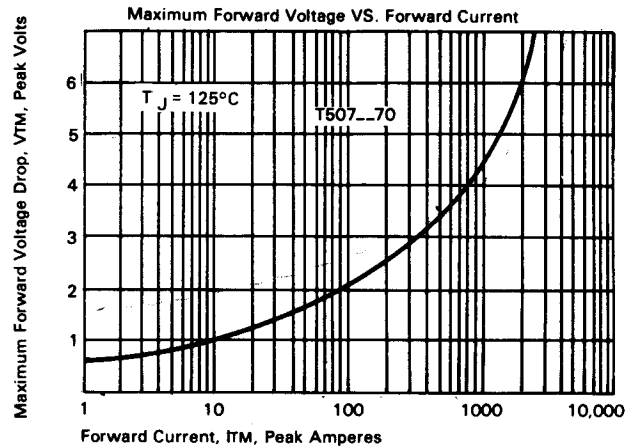

FAST SWITCHING THYRISTORS

Fast Switching SCR T507_70

70A Avg.
(110 RMS)
Up to 1400 Volts
10-50 μ s

Sinusoidal Current Data



ENERGY PER PULSE FOR SINUSOIDAL PULSES

Trapezoidal Wave Current Data

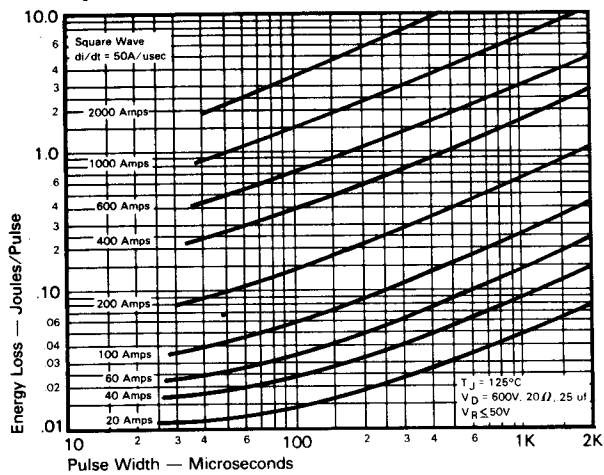

ENERGY PER PULSE FOR TRAPEZOIDAL PULSES
($di/dt = 50\text{A}/\text{usec}$)

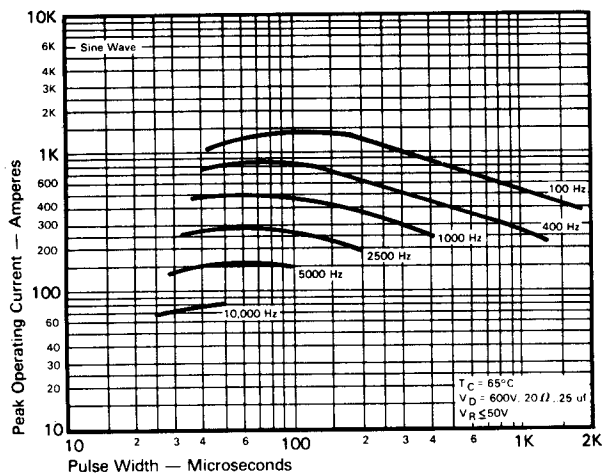

MAXIMUM ALLOWABLE PEAK ON-STATE CURRENT
vs. PULSE WIDTH ($T_C = 65^\circ\text{C}$)

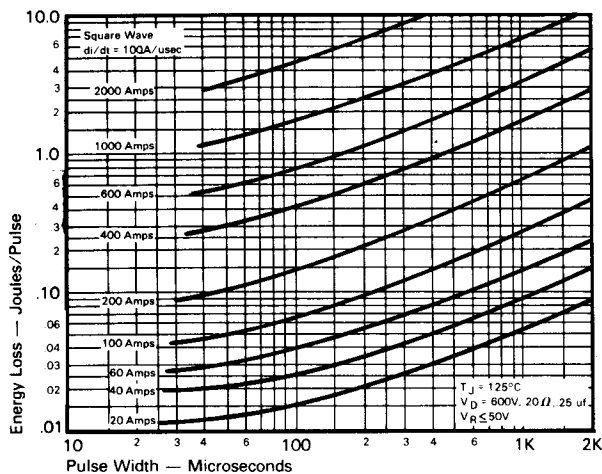

ENERGY PER PULSE FOR TRAPEZOIDAL PULSES
($di/dt = 100\text{A}/\text{usec}$)



MAXIMUM ALLOWABLE PEAK ON-STATE CURRENT
vs. PULSE WIDTH ($T_C = 90^\circ\text{C}$)

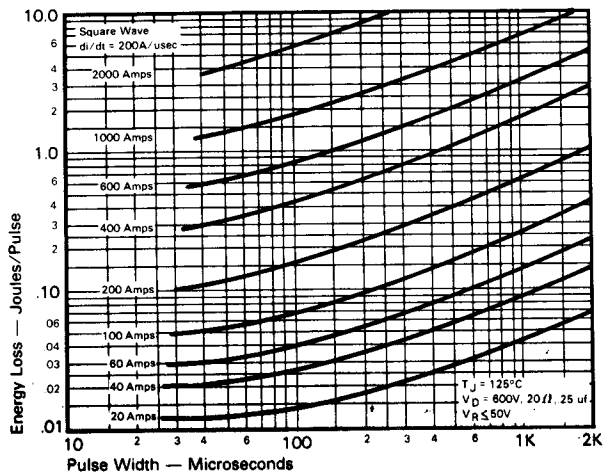

ENERGY PER PULSE FOR TRAPEZOIDAL PULSES
($di/dt = 200\text{A}/\text{usec}$)

70A Avg.
(110 RMS)
Up to 1400 Volts
10-50 μ s

Fast Switching
SCR
T507_70

Trapezoidal Wave Current Data
($T_C = 65^\circ C$)

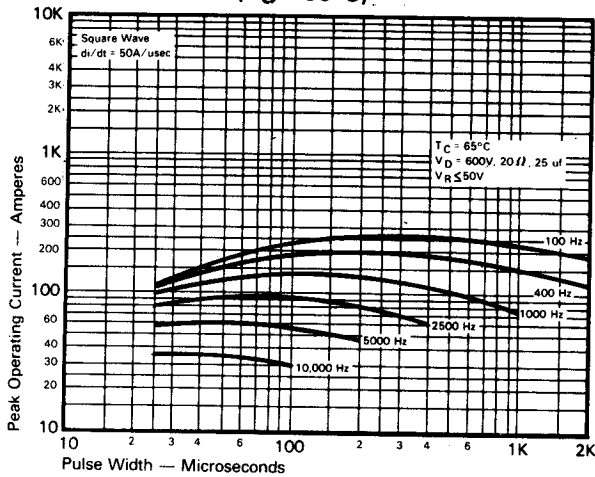

MAXIMUM ALLOWABLE PEAK ON-STATE CURRENT vs. PULSE WIDTH ($di/dt = 50A/usec$)

Trapezoidal Wave Current Data
($T_C = 90^\circ C$)

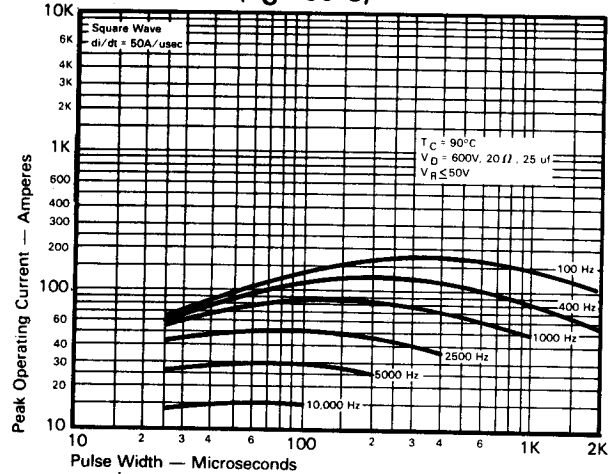

MAXIMUM ALLOWABLE PEAK ON-STATE CURRENT vs. PULSE WIDTH ($di/dt = 50A/usec$)

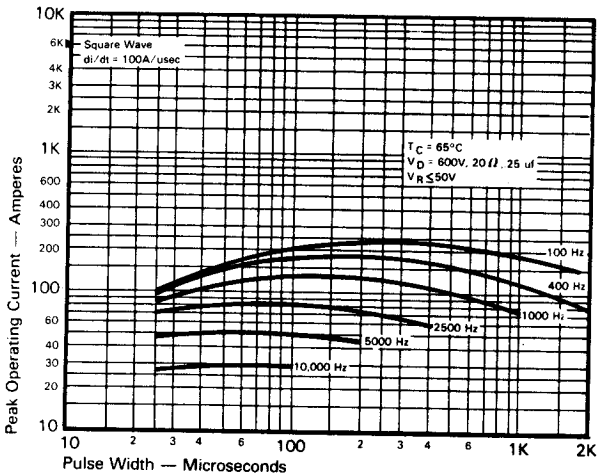

MAXIMUM ALLOWABLE PEAK ON-STATE CURRENT vs. PULSE WIDTH ($di/dt = 100A/usec$)

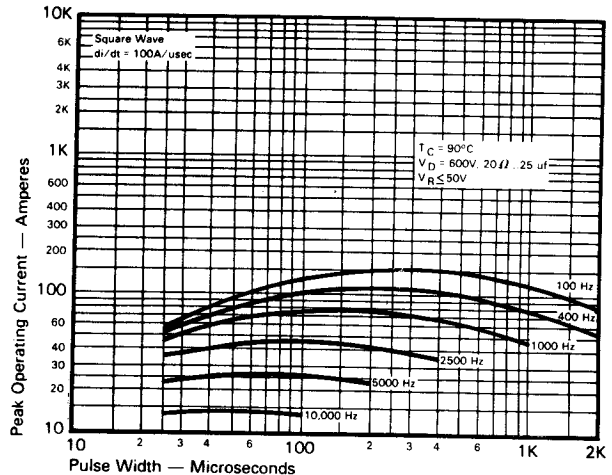

MAXIMUM ALLOWABLE PEAK ON-STATE CURRENT vs. PULSE WIDTH ($di/dt = 100A/usec$)

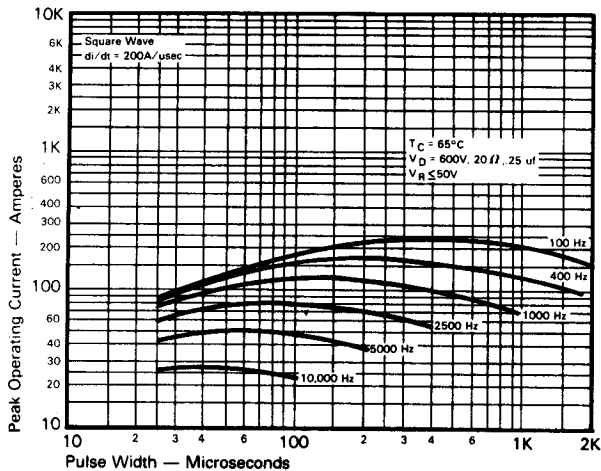

MAXIMUM ALLOWABLE PEAK ON-STATE CURRENT vs. PULSE WIDTH ($di/dt = 200A/usec$)

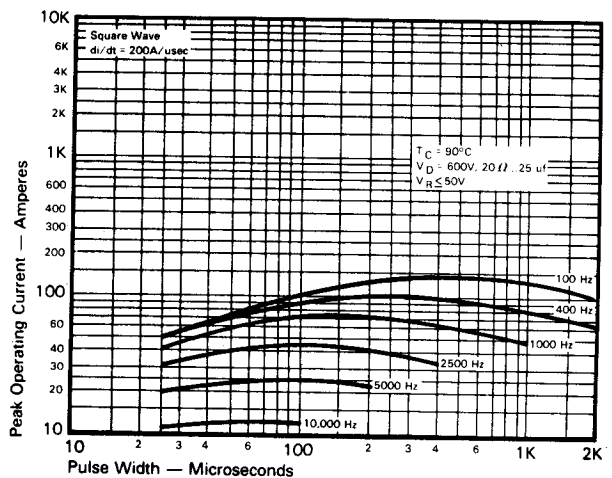

MAXIMUM ALLOWABLE PEAK ON-STATE CURRENT vs. PULSE WIDTH ($di/dt = 200A/usec$)

FAST SWITCHING
THYRISTORS



CASE NUMBER T50
 NOMINAL DIMENSIONS

STRIKE DISTANCE = .44 INCH / 11.2 MM MIN.
 CREEPAGE DISTANCE = .44 INCH / 11.2 MM MIN.

SYM.	A	B	C	D	E	F	G	H	J	K
INCHES	.81	.34	.98	1.58	.89	6.12	.48	.266	7.44	.146
MM	20.6	8.6	24.9	40.1	22.6	155.4	12.2	6.76	189.0	3.71

ALL DIMENSIONS ARE REFERENCE