

# Fast Switching SCR T507\_70

70A Avg.  
(110 RMS)  
Up to 1400 Volts  
10-50  $\mu$ s

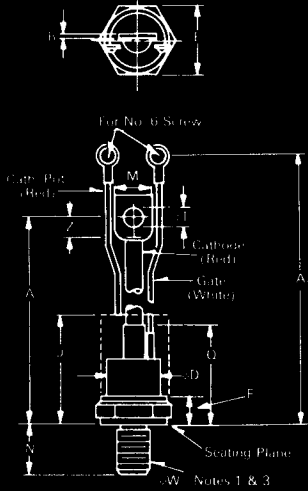

Conforms to TO-94 Outline

Symbol	Inches		Millimeters	
	Min.	Max.	Min.	Max.
A	5.775	6.265	146.69	159.13
A <sub>1</sub>	6.850	7.500	173.99	190.50
B	.055	.075	1.40	1.91
$\phi$ D	.860	1.000	21.84	25.40
E	1.031	1.063	26.19	27.00
F	.255	.400	6.48	10.16
J	2.50		63.50	
M	.437	.650	11.10	16.51
N	.796	.827	20.24	21.01
Q		1.675		42.55
$\phi$ T	.260	.291	6.60	7.39
Z	.250		6.35	
$\phi$ W	$\frac{1}{2}$ -20 UNF-2A			

- Creep & Strike Distance.  
T500—.50 in. min. (12.85 mm).  
(In accordance with NEMA standards.)  
Finish—Nickel Plate.  
Approx. Weight—5 oz. (142 g).  
1. Complete threads to extend to within 2½ threads of seating plane.  
2. Angular orientation of terminals is undefined.  
3. Pitch diameter of  $\frac{1}{2}$ -20 UNF-2A (coated) threads (ASA B1.1-1960).  
4. Dimension "J" denotes seated height with leads bent at right angles.

\*for 10  $\mu$ sec turn-off,  
consult factory

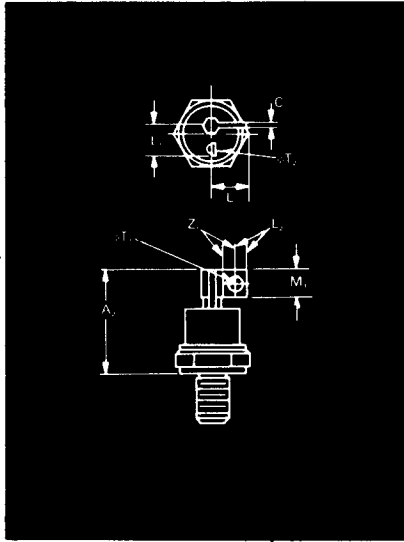

Conforms to TO-83 Outline

Symbol	Inches		Millimeters	
	Min.	Max.	Min.	Max.
A <sub>2</sub>		1.810		45.97
C	.070	.110	1.78	2.79
L		.650		16.51
L <sub>1</sub>	.420	.520	10.67	13.21
L <sub>2</sub>	.180		4.57	
M <sub>1</sub>	.360	.470	9.14	11.94
$\phi$ T <sub>1</sub>	.190	.235	4.83	5.97
$\phi$ T <sub>2</sub>	.060	.080	1.52	2.03
Z <sub>1</sub>	.180		4.57	
$\phi$ W	$\frac{1}{2}$ -20 UNF-2A			

- Approx. Weight—4 oz. (114 g).  
1. Basic dimensions of TO-94 and TO-83 are same except as noted.

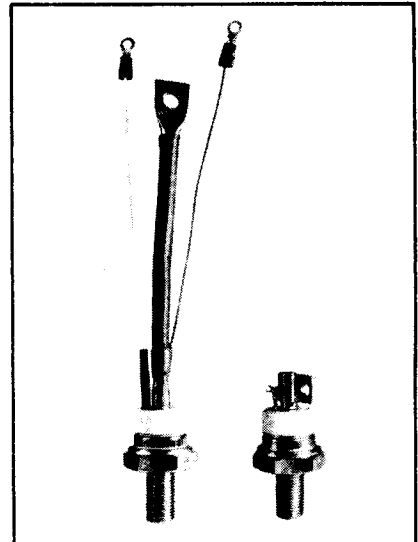

### Features:

- Center fired di/namic
- High di/dt with soft gate control
- High frequency operation
- Sinusoidal waveform operation to 20 KHz
- Rectangular waveform operation to 20 KHz
- Low dynamic forward voltage drop
- Low switching losses at high frequency
- Lifetime Guarantee

### Applications:

- Inverters for UPS
- Induction Heating
- AC Motor Control
- Switching power supplies
- Cycloconverters
- Choppers
- Crowbars

### Ordering Information

Type	Voltage		Current		Turn-off		Gate current		Leads		
Code	V <sub>DRM</sub> and V <sub>RRM</sub> (V)	Code	I <sub>T(av)</sub> (A)	Code	t <sub>q</sub> ( $\mu$ sec)	Code	I <sub>GT</sub> (ma)	Code	Case	Code	
T507	100	01	70	70	10	5	150	4	TO-94	AQ	
	200	02									
	300	03									
	400	04									
	500	05								TO-83	AB
	600	06									
	700	07									
	800	08									
	900	09									
	1000	10									
	1100	11									
	1200	12									
	1400	*14									

Type	Voltage	Current	Turn Off	Gate Current	Leads
T 5 0 7 0 8 9 0	5	0	7	0	8
6	4	A	Q		

### Example

Obtain optimum device performance for your application by selecting proper Order Code.

Type T 507 rated at 70 A average with V<sub>DRM</sub> = 800V.  
I<sub>GT</sub> = 150 ma, t<sub>q</sub> = 20  $\mu$ sec max. and flex leads—order as:

**70A Avg.  
(110 RMS)  
Up to 1400 Volts  
10-50  $\mu$ s**

**Fast Switching  
SCR  
T507\_\_70**

**Voltage**

**Blocking State Maximums @ ( $T_J = 125^\circ\text{C}$ )**

	Symbol	100	200	300	400	500	600	700	800	900	1000	1100	1200	1400
Repetitive peak forward blocking voltage, V	$V_{DRM}$	100	200	300	400	500	600	700	800	900	1000	1100	1200	1400
Repetitive peak reverse voltage, V	$V_{RRM}$	100	200	300	400	500	600	700	800	900	1000	1100	1200	1400
Non-repetitive transient peak reverse voltage, $t \leq 5.0$ msec, V	$V_{RSM}$	200	300	400	500	600	700	800	900	1000	1100	1200	1300	1500
Forward leakage current, mA peak	$I_{DRM}$	← 15 →												
Reverse leakage current, mA peak	$I_{RRM}$	← 15 →												

**Current**

**Conducting State Maximums  
( $T_J = 125^\circ\text{C}$ )**

	Symbol	T507__70
RMS forward current, A	$I_T(\text{rms})$	110
Ave. forward current, A	$I_T(\text{av})$	70
One-half cycle surge current <sup>①</sup> , A	$I_{TSM}$	1200
$I^2t$ for fusing (for times $\geq 8.3$ ms) A <sup>2</sup> sec.	$I^2t$	6000
Forward voltage drop at $I_{TM} = 500\text{A}$ and $T_J = 25^\circ\text{C}$ , V	$V_{TM}$	3.5
Min. repetitive $di/dt$ <sup>①②③</sup> , A/ $\mu$ sec	$di/dt$	100

**Switching**

( $T_J = 25^\circ\text{C}$ )

	Symbol	
Max. turn-off time, $I_T = 50\text{A}$ , $T_J = 125^\circ\text{C}$ , $di/dt = 5$ A/ $\mu$ sec, reapplied $dv/dt =$ $20\text{V}/\mu$ sec linear to $0.8 V_{DRM}$ , $\mu$ sec <sup>①②</sup>	$t_q$	10 to 50
Typ. turn-on-time, $I_T = 100\text{A}$ $V_D = 100\text{V}$ <sup>③</sup> , $\mu$ sec	$t_{on}$	3.5
Min. critical $dv/dt$ , exponential to $V_{DRM}$ , $T_J = 125^\circ\text{C}$ , V/ $\mu$ sec <sup>②③</sup>	$dv/dt$	200
Min. $di/dt$ non-repetitive, A/ $\mu$ sec <sup>①②③</sup>	$di/dt$	800

**Gate**

**Maximum Parameters  
( $T_J = 25^\circ\text{C}$ )**

	Symbol	
Gate current to trigger at $V_D = 12\text{V}$ , mA	$I_{GT}$	150
Gate voltage to trigger at $V_D = 12\text{V}$ , V	$V_{GT}$	3
Non-triggering gate voltage, $T_J = 125^\circ\text{C}$ , and rated $V_{DRM}$ , V	$V_{GDM}$	0.15
Peak forward gate current, A	$I_{GTM}$	4
Peak reverse gate voltage, V	$V_{GRM}$	5
Peak gate power, Watts	$P_{GM}$	16
Average gate power, Watts	$P_{G(av)}$	3

**Thermal and Mechanical**

	Symbol	
Min., Max. oper. junction temp., $^\circ\text{C}$	$T_J$	-40 to +125
Min., Max. storage temp., $^\circ\text{C}$	$T_{stg}$	-40 to +150
Max. mounting torque, in lb. <sup>①</sup>		130
Max. Thermal resistance <sup>①</sup>		
Junction to case, $^\circ\text{C}/\text{Watt}$	$R_{\theta JC}$	.28
Case to sink, lubricated, $^\circ\text{C}/\text{Watt}$	$R_{\theta CS}$	.12

- ① Consult recommended mounting procedures.
- ② Applies for zero or negative gate bias.
- ③ Per JEDEC RS-397, 5.2.2.1.
- ④ With recommended gate drive.
- ⑤ Higher  $dv/dt$  ratings available, consult factory.
- ⑥ Per JEDEC standard RS-397, 5.2.2.6.
- ⑦ For operation with antiparallel diode, consult factory.

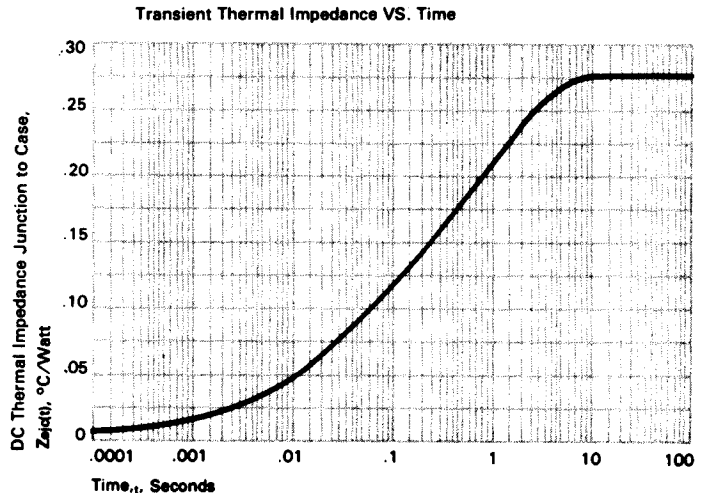
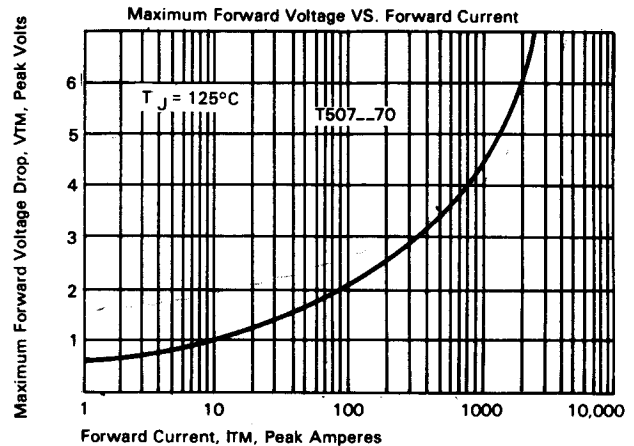

FAST SWITCHING THYRISTORS

# Fast Switching SCR T507\_70

70A Avg.  
(110 RMS)  
Up to 1400 Volts  
10-50  $\mu$ s

## Sinusoidal Current Data



ENERGY PER PULSE FOR SINUSOIDAL PULSES

## Trapezoidal Wave Current Data

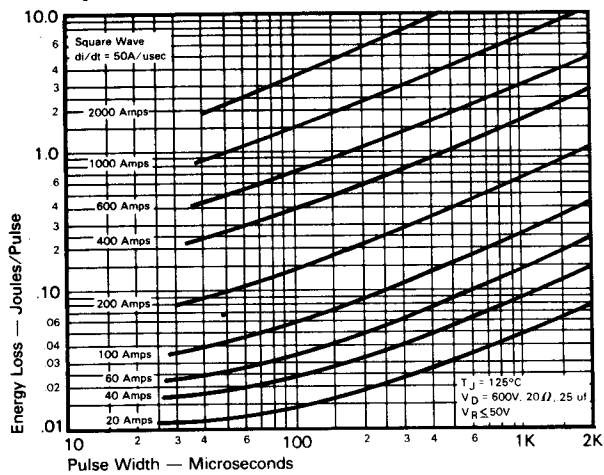

ENERGY PER PULSE FOR TRAPEZOIDAL PULSES  
( $di/dt = 50\text{A}/\text{usec}$ )

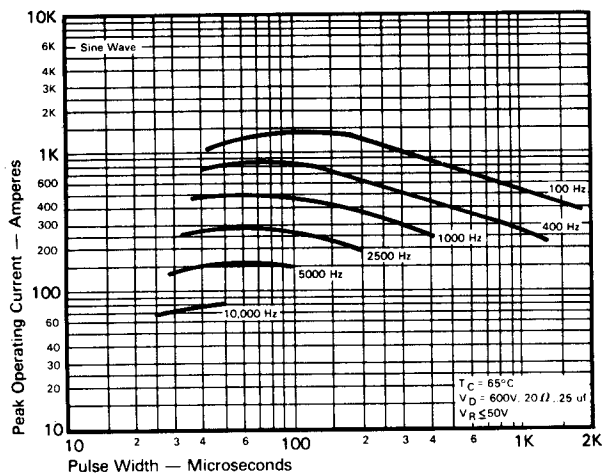

MAXIMUM ALLOWABLE PEAK ON-STATE CURRENT  
vs. PULSE WIDTH ( $T_C = 65^\circ\text{C}$ )

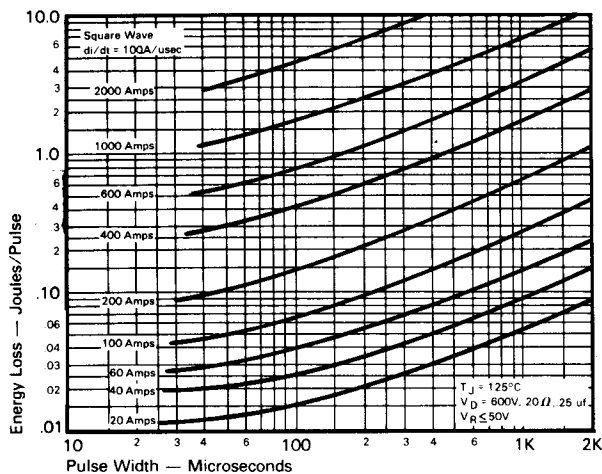

ENERGY PER PULSE FOR TRAPEZOIDAL PULSES  
( $di/dt = 100\text{A}/\text{usec}$ )



MAXIMUM ALLOWABLE PEAK ON-STATE CURRENT  
vs. PULSE WIDTH ( $T_C = 90^\circ\text{C}$ )

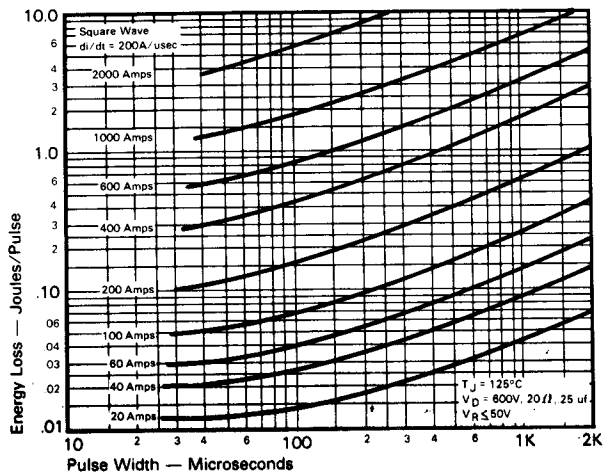

ENERGY PER PULSE FOR TRAPEZOIDAL PULSES  
( $di/dt = 200\text{A}/\text{usec}$ )

70A Avg.  
(110 RMS)  
Up to 1400 Volts  
10-50  $\mu$ s

Fast Switching  
SCR  
T507\_70

**Trapezoidal Wave Current Data**  
( $T_C = 65^\circ C$ )

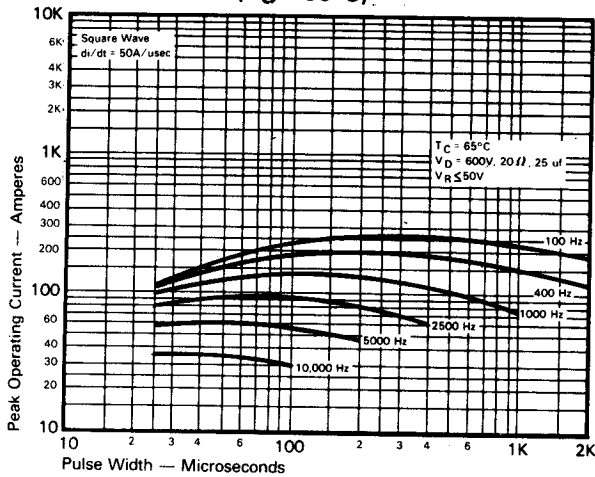

**MAXIMUM ALLOWABLE PEAK ON-STATE CURRENT vs. PULSE WIDTH ( $di/dt = 50A/usec$ )**

**Trapezoidal Wave Current Data**  
( $T_C = 90^\circ C$ )

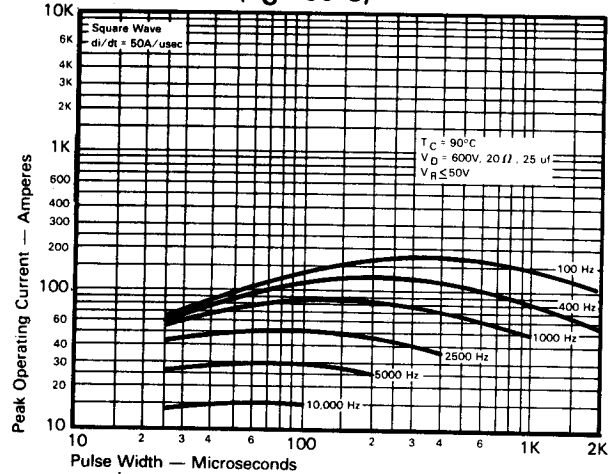

**MAXIMUM ALLOWABLE PEAK ON-STATE CURRENT vs. PULSE WIDTH ( $di/dt = 50A/usec$ )**

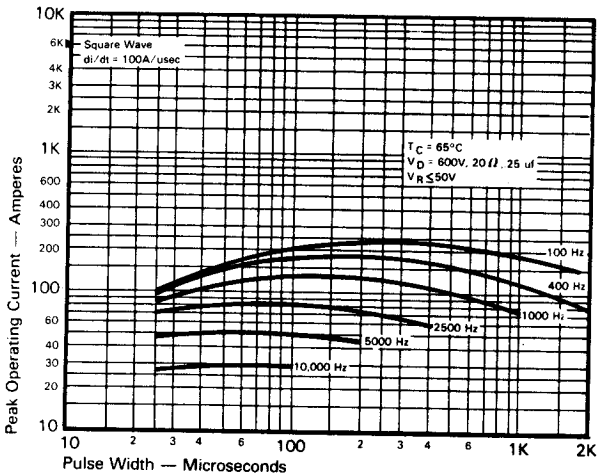

**MAXIMUM ALLOWABLE PEAK ON-STATE CURRENT vs. PULSE WIDTH ( $di/dt = 100A/usec$ )**

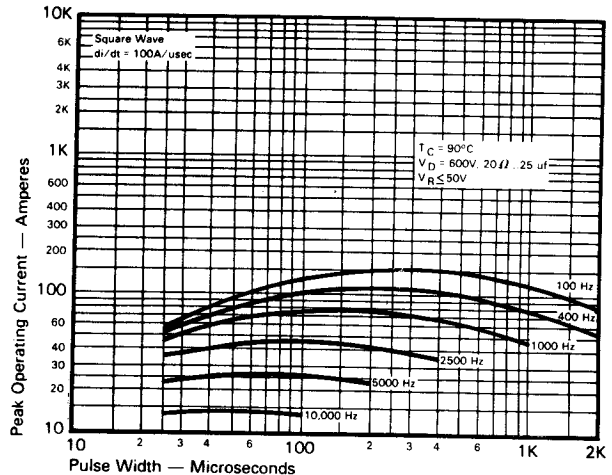

**MAXIMUM ALLOWABLE PEAK ON-STATE CURRENT vs. PULSE WIDTH ( $di/dt = 100A/usec$ )**

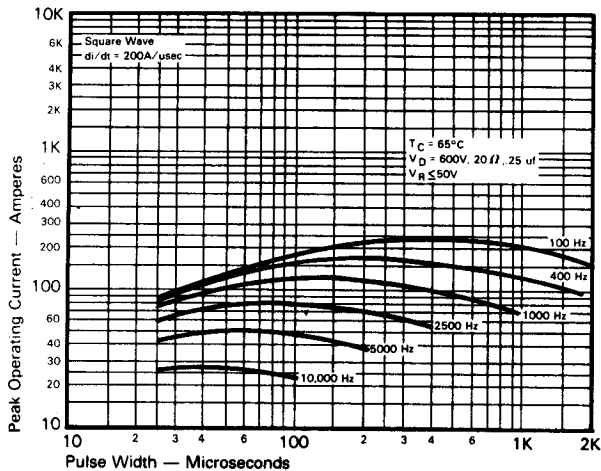

**MAXIMUM ALLOWABLE PEAK ON-STATE CURRENT vs. PULSE WIDTH ( $di/dt = 200A/usec$ )**

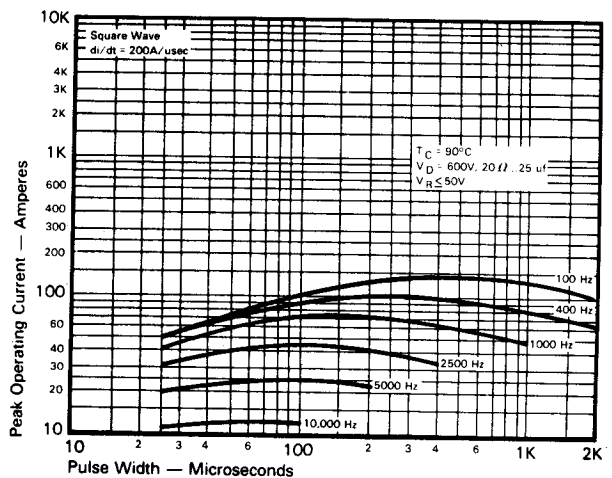

**MAXIMUM ALLOWABLE PEAK ON-STATE CURRENT vs. PULSE WIDTH ( $di/dt = 200A/usec$ )**

FAST SWITCHING THYRISTORS



CASE NUMBER T50  
NOMINAL DIMENSIONS

STRIKE DISTANCE = .44 INCH / 11.2 MM MIN.  
CREEPAGE DISTANCE = .44 INCH / 11.2 MM MIN.

SYM.	A	B	C	D	E	F	G	H	J	K
INCHES	.81	.34	.98	1.58	.89	6.12	.48	.266	7.44	.146
MM	20.6	8.6	24.9	40.1	22.6	155.4	12.2	6.76	189.0	3.71

ALL DIMENSIONS ARE REFERENCE