

Fast Switching SCR T507_80

80A Avg.
(125 RMS)
Up to 1400 Volts
10-50 μ s

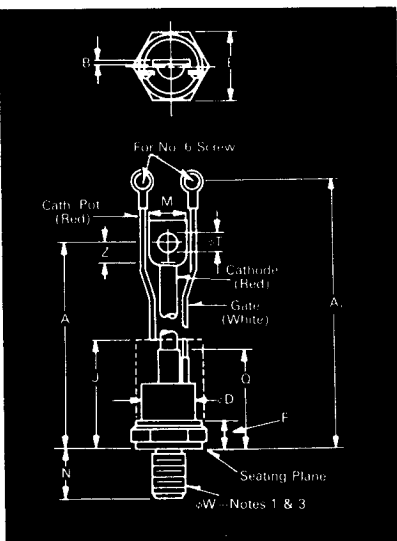

Conforms to TO-94 Outline

| Symbol | Inches | | Millimeters | |
|----------------|-------------|-------|-------------|--------|
| | Min. | Max. | Min. | Max. |
| A | 5.775 | 6.265 | 146.69 | 159.13 |
| A ₁ | 6.850 | 7.500 | 173.99 | 190.50 |
| B | .055 | .075 | 1.40 | 1.91 |
| φD | .860 | 1.000 | 21.84 | 25.40 |
| E | 1.031 | 1.063 | 26.19 | 27.00 |
| F | .255 | .400 | 6.48 | 10.16 |
| J | 2.50 | | 63.50 | |
| M | .437 | .650 | 11.10 | 16.51 |
| N | .796 | .827 | 20.24 | 21.01 |
| Q | | 1.675 | | 42.55 |
| φT | .260 | .291 | 6.60 | 7.39 |
| Z | .250 | | 6.35 | |
| φW | ½-20 UNF-2A | | | |

Creep & Strike Distance.

T500---50 in. min. (12.85 mm).

(In accordance with NEMA standards.)

Finish—Nickel Plate.

Approx. Weight—5 oz. (142 g).

1. Complete threads to extend to within 2½ threads of seating plane.
2. Angular orientation of terminals is undefined.
3. Pitch diameter of ½-20 UNF-2A (coated) threads (ASA B1.1-1960).
4. Dimension "J" denotes seated height with leads bent at right angles.

*for 10 μ sec turn-off,
consult factory

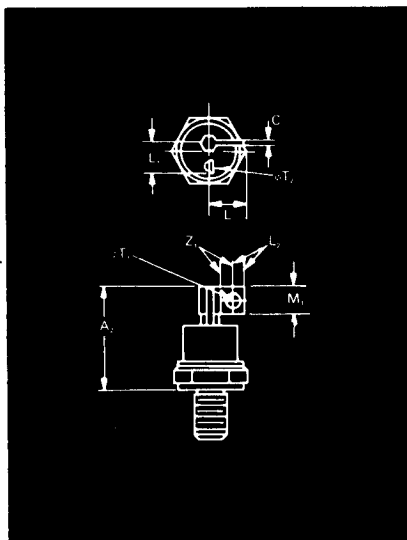

Conforms to TO-83 Outline

| Symbol | Inches | | Millimeters | |
|-----------------|-------------|-------|-------------|-------|
| | Min. | Max. | Min. | Max. |
| A ₂ | | 1.810 | | 45.97 |
| C | .070 | .110 | 1.78 | 2.79 |
| L | | .650 | | 16.51 |
| L ₁ | .420 | .520 | 10.67 | 13.21 |
| L ₂ | .180 | | 4.57 | |
| M ₁ | .360 | .470 | 9.14 | 11.94 |
| φT ₁ | .190 | .235 | 4.83 | 5.97 |
| φT ₂ | .060 | .080 | 1.52 | 2.03 |
| Z ₁ | .180 | | 4.57 | |
| φW | ½-20 UNF-2A | | | |

Approx. Weight—4 oz. (114 g).

1. Basic dimensions of TO-94 and TO-83 are same except as noted.

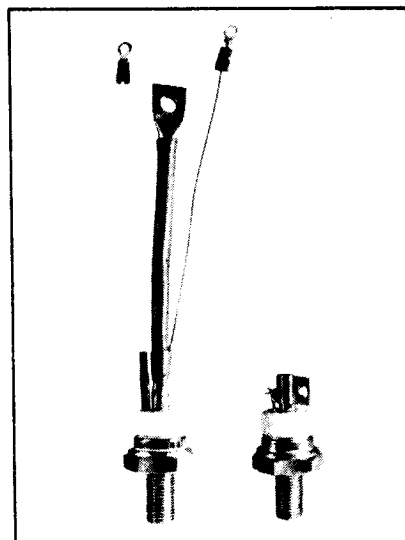

Features:

- Center fired di/damic
- High di/dt with soft gate control
- High frequency operation
- Sinusoidal waveform operation to 20 KHz
- Rectangular waveform operation to 20 KHz
- Low dynamic forward voltage drop
- Low switching losses at high frequency
- Lifetime Guarantee

Applications:

- Inverters for UPS
- Induction Heating
- AC Motor Control
- Switching power supplies
- Cycloconverters
- Choppers
- Crowbars

Ordering Information

| Type | Voltage | | Current | | Turn-off | | Gate-current | | Leads | | | |
|------|---|------|------------------------|------|-----------------------|------|----------------------|------|-------|------|-------|----|
| | V _{DRM} and V _{RRM} (V) | Code | I _{T(av)} (A) | Code | t _q (μsec) | Code | I _{GT} (ma) | Code | Case | Code | | |
| T507 | 100 | 01 | 80 | 80 | 10 | 8 | 150 | 4 | TO-94 | AQ | | |
| | 200 | 02 | | | 15 | 7 | | | | | | |
| | 300 | 03 | | | 20 | 6 | | | | | | |
| | 400 | 04 | | | 25 | 5 | | | | | | |
| | 500 | 05 | | | 30 | 4 | | | | | | |
| | 600 | 06 | | | 40 | 3 | | | | | | |
| | 700 | 07 | | | 50 | 2 | | | | | | |
| | 800 | 08 | | | φD | C | | | | | TO-83 | AB |
| | 900 | 08 | | | | | | | | | | |
| | 1000 | 10 | | | | | | | | | | |
| | 1100 | 11 | | | | | | | | | | |
| | 1200 | 12 | | | | | | | | | | |
| | 1400 | *14 | | | | | | | | | | |

Example

Obtain optimum device performance for your application by selecting proper Order Code.

Type T 507 rated at 80 A average with V_{DRM} = 1000V,
I_{GT} = 150 ma, t_q = 30 μ sec max. and flex leads—order as:

| Type | Voltage | Current | Turn Off | Gate Current | Leads |
|---------|---------|---------|----------|--------------|-------|
| T 5 0 7 | 1 0 | 8 0 | 5 | 4 | A Q |

**80A Avg.
(125 RMS)
Up to 1400 Volts
10-50 μ s**

**Fast Switching
SCR
T507_80**

Voltage

Blocking State Maximums @ ($T_J = 125^\circ\text{C}$)

| Symbol | 100 | 200 | 300 | 400 | 500 | 600 | 700 | 800 | 900 | 1000 | 1100 | 1200 | 1400 |
|---|------------------|-----|-----|-----|-----|-----|-----|-----|------|------|------|------|------|
| Repetitive peak forward blocking voltage, V_{DRM} | 100 | 200 | 300 | 400 | 500 | 600 | 700 | 800 | 900 | 1000 | 1100 | 1200 | 1400 |
| Repetitive peak reverse voltage, V_{RRM} | 100 | 200 | 300 | 400 | 500 | 600 | 700 | 800 | 900 | 1000 | 1100 | 1200 | 1400 |
| Non-repetitive transient peak reverse voltage, V_{RSM} $t \leq 5.0$ msec | 200 | 300 | 400 | 500 | 600 | 700 | 800 | 900 | 1000 | 1100 | 1200 | 1300 | 1500 |
| Forward leakage current, mA peak I_{DRM} | ←----- 15 -----> | | | | | | | | | | | | |
| Reverse leakage current, mA peak I_{RRM} | ←----- 15 -----> | | | | | | | | | | | | |

Current

Conducting State Maximums
($T_J = 125^\circ\text{C}$)

| Symbol | T507_80 |
|---|---------|
| RMS forward current, A $I_T(\text{rms})$ | 125 |
| Ave. forward current, A $I_T(\text{av})$ | 80 |
| One-half cycle surge current ^③ , A I_{TSM} | 1400 |
| I^2t for fusing (for times ≥ 8.3 ms) A ² sec I^2t | 8150 |
| Forward voltage drop at $I_{TM} = 500\text{A}$ and $T_J = 25^\circ\text{C}$, V V_{TM} | 3.2 |
| Min. repetitive di/dt ^{④⑤⑥} , A/ μ sec di/dt | 150 |

Switching

($T_J = 25^\circ\text{C}$)

| Symbol | |
|--|----------|
| Max. turn-off time, $I_T = 50\text{A}$, $T_J = 125^\circ\text{C}$, $di/dt = 5$ A/ μ sec, reapplied $dv/dt =$ $20\text{V}/\mu\text{sec}$ linear to $0.8 V_{DRM}$, μsec ^{⑦⑧} t_q | 10 to 50 |
| Typ. turn-on time, $I_T = 100\text{A}$, $V_D = 100\text{V}$, μsec t_{on} | 3.5 |
| Min. critical dv/dt , exponential to V_{DRM} , $T_J = 125^\circ\text{C}$, V/ μsec ^⑨ dv/dt | 200 |
| Min. di/dt non-repetitive, A/ μsec ^{⑩⑪⑫} di/dt | 800 |

Gate

Maximum Parameters
($T_J = 25^\circ\text{C}$)

| Symbol | |
|---|------|
| Gate current to trigger at $V_D = 12\text{V}$, mA I_{GT} | 150 |
| Gate voltage to trigger at $V_D = 12\text{V}$, V V_{GT} | 3 |
| Non-triggering gate voltage, $T_J = 125^\circ\text{C}$, and rated V_{DRM} , V V_{GDM} | 0.15 |
| Peak forward gate current, A I_{GTM} | 4 |
| Peak reverse gate voltage, V V_{GRM} | 5 |
| Peak gate power, Watts P_{GM} | 16 |
| Average gate power, Watts $P_{G(av)}$ | 3 |

Thermal and Mechanical

| Symbol | |
|--|-------------|
| Min., Max. oper. junction temp., $^\circ\text{C}$ T_J | -40 to +125 |
| Min., Max. storage temp., $^\circ\text{C}$ T_{stg} | -40 to +150 |
| Max. mounting torque, in lb. ⑬ | 130 |
| Max. Thermal resistance ⑭ | |
| Junction to case, $^\circ\text{C}/\text{Watt}$ $R_{\theta JC}$ | .28 |
| Case to sink, lubricated, $^\circ\text{C}/\text{Watt}$ $R_{\theta CS}$ | .12 |

- ① Consult recommended mounting procedures.
- ② Applies for zero or negative gate bias.
- ③ Per JEDEC RS-397, 5.2.2.1.
- ④ With recommended gate drive.
- ⑤ Higher dv/dt ratings available, consult factory.
- ⑥ Per JEDEC standard RS-397, 5.2.2.6.
- ⑦ For operation with antiparallel diode, consult factory.

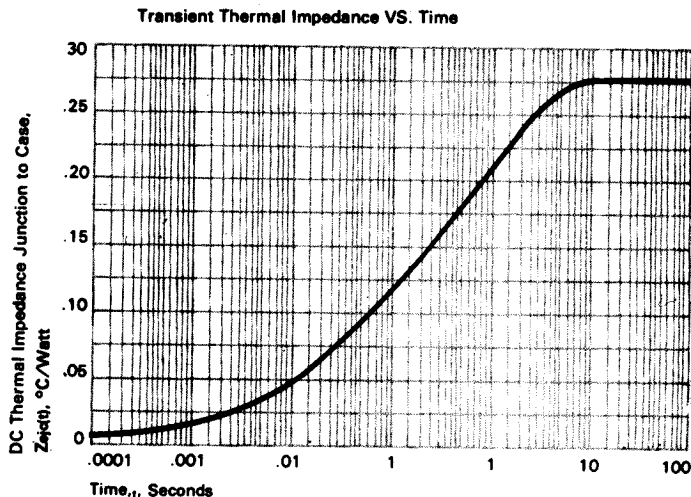
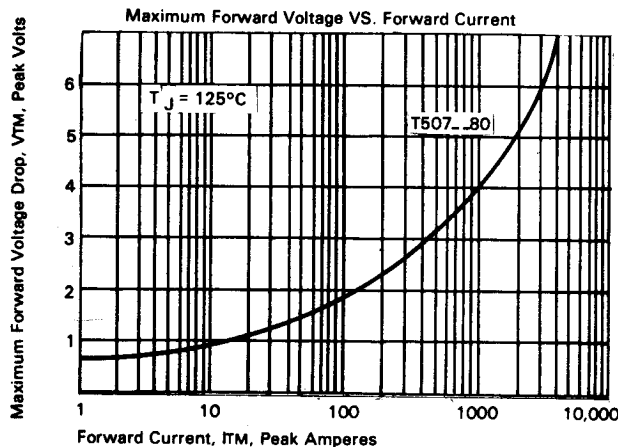

FAST SWITCHING THYRISTORS

Fast Switching SCR T507_80

80A Avg.
(125 RMS)
Up to 1400 Volts
10-50 μ s

Sinusoidal Current Data

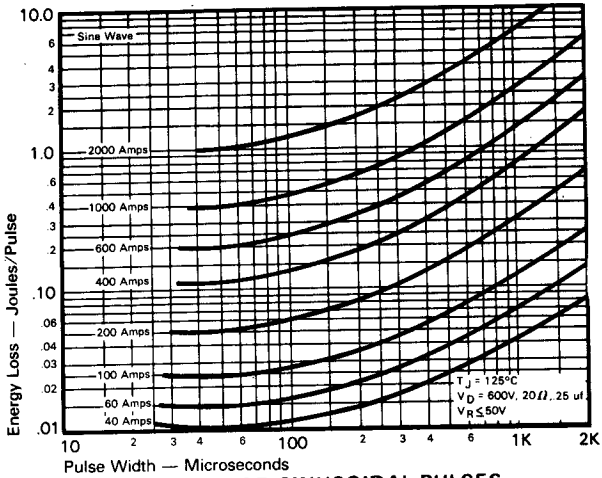

Trapezoidal Wave Current Data

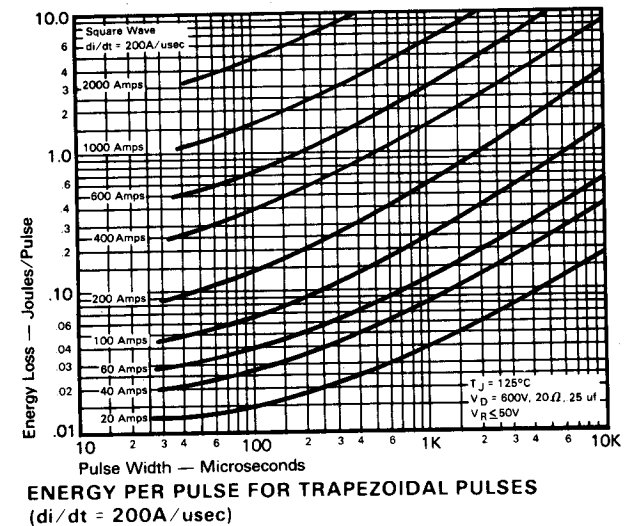
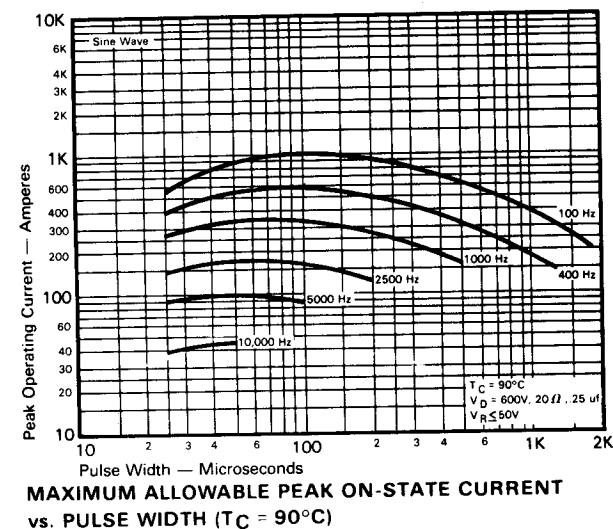
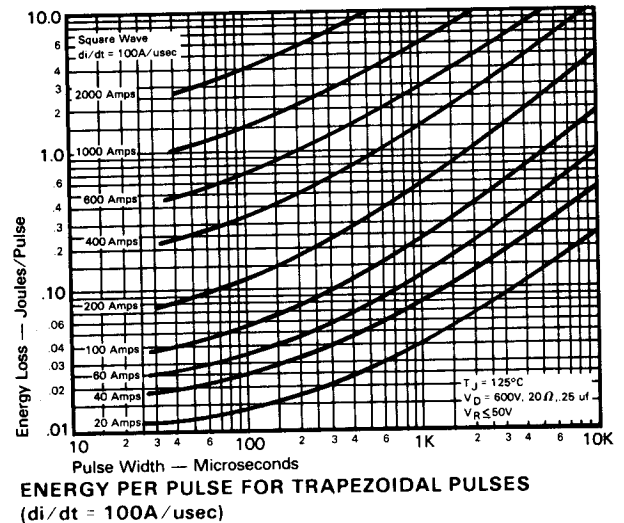
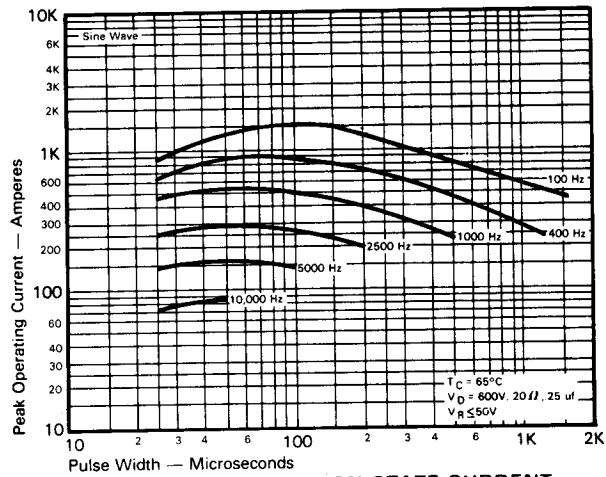
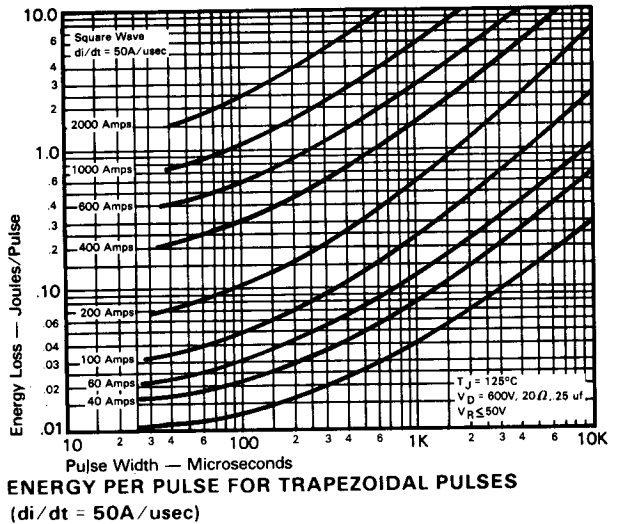

FAST SWITCHING THYRISTORS

**80A Avg.
(125 RMS)
Up to 1400 Volts
10-50 μ s**

**Fast Switching
SCR
T507_80**

**Trapezoidal Wave Current Data
($T_C = 65^\circ\text{C}$)**

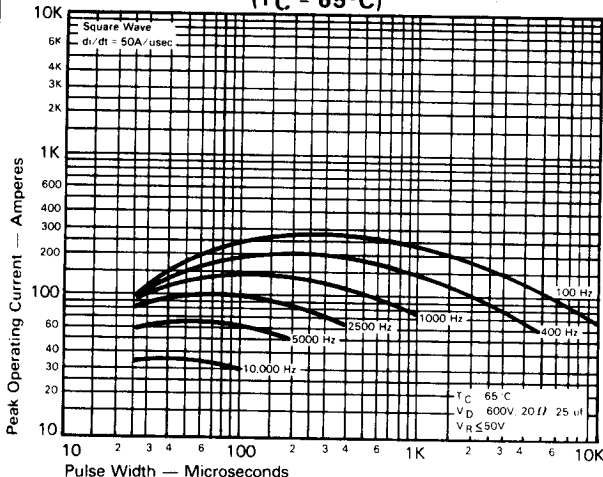

MAXIMUM ALLOWABLE PEAK ON-STATE CURRENT vs. PULSE WIDTH ($di/dt = 50A/usec$)

**Trapezoidal Wave Current Data
($T_C = 90^\circ\text{C}$)**

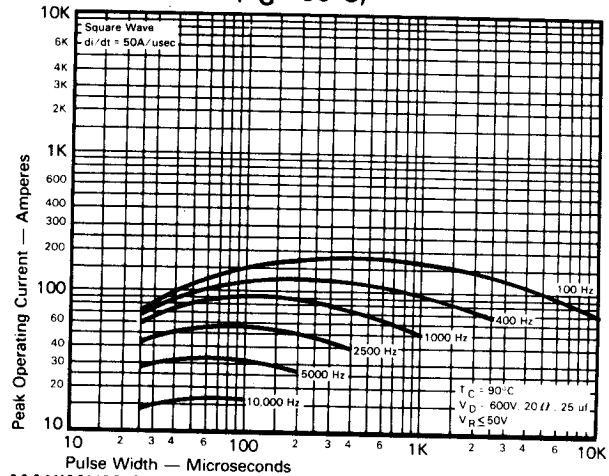

MAXIMUM ALLOWABLE PEAK ON-STATE CURRENT vs. PULSE WIDTH ($di/dt = 50A/usec$)

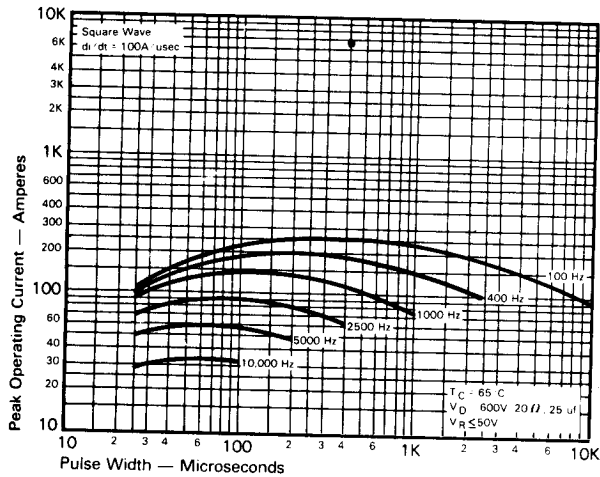

MAXIMUM ALLOWABLE PEAK ON-STATE CURRENT vs. PULSE WIDTH ($di/dt = 100A/usec$)

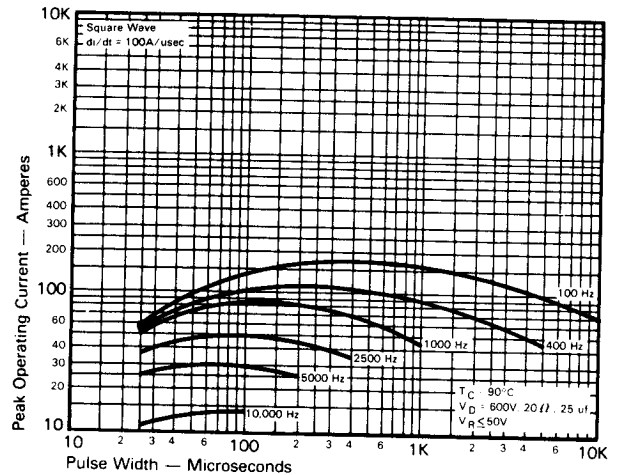

MAXIMUM ALLOWABLE PEAK ON-STATE CURRENT vs. PULSE WIDTH ($di/dt = 100A/usec$)

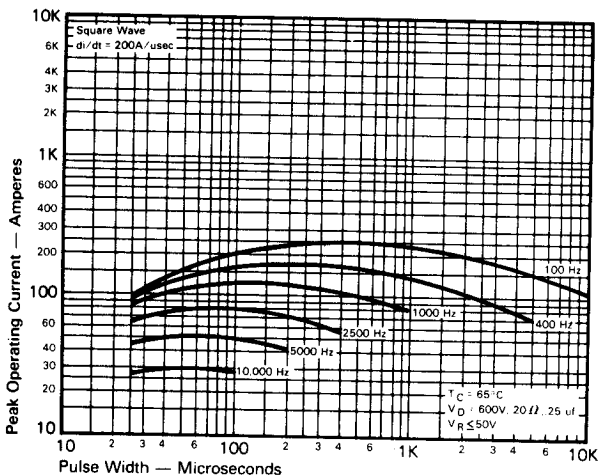

MAXIMUM ALLOWABLE PEAK ON-STATE CURRENT vs. PULSE WIDTH ($di/dt = 200A/usec$)

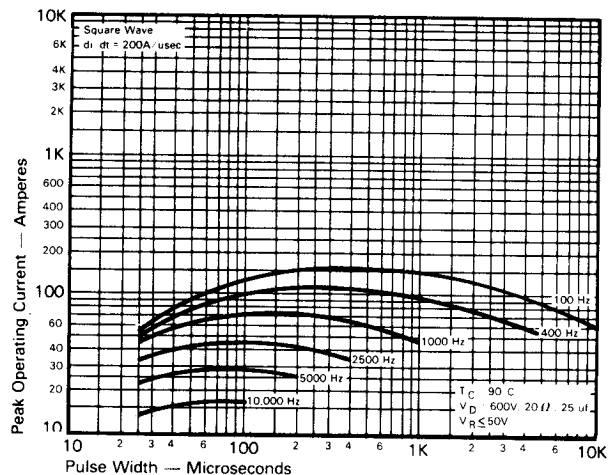

MAXIMUM ALLOWABLE PEAK ON-STATE CURRENT vs. PULSE WIDTH ($di/dt = 200A/usec$)

FAST SWITCHING THYRISTORS



CASE NUMBER T50
 NOMINAL DIMENSIONS

STRIKE DISTANCE = .44 INCH / 11.2 MM MIN.
 CREEPAGE DISTANCE = .44 INCH / 11.2 MM MIN.

| SYM. | A | B | C | D | E | F | G | H | J | K |
|--------|------|-----|------|------|------|-------|------|------|-------|------|
| INCHES | .81 | .34 | .98 | 1.58 | .89 | 6.12 | .48 | .266 | 7.44 | .146 |
| MM | 20.6 | 8.6 | 24.9 | 40.1 | 22.6 | 155.4 | 12.2 | 6.76 | 189.0 | 3.71 |

ALL DIMENSIONS ARE REFERENCE