

Powerex, Inc., 200 Hillis Street, Youngwood, Pennsylvania 15697-1800 (412) 925-7272
 Powerex, Europe, S.A. 428 Avenue G. Durand, BP107, 72003 Le Mans, France (43) 41.14.14

Fast Recovery Rectifier
1200 Amperes Average
3600 Volts

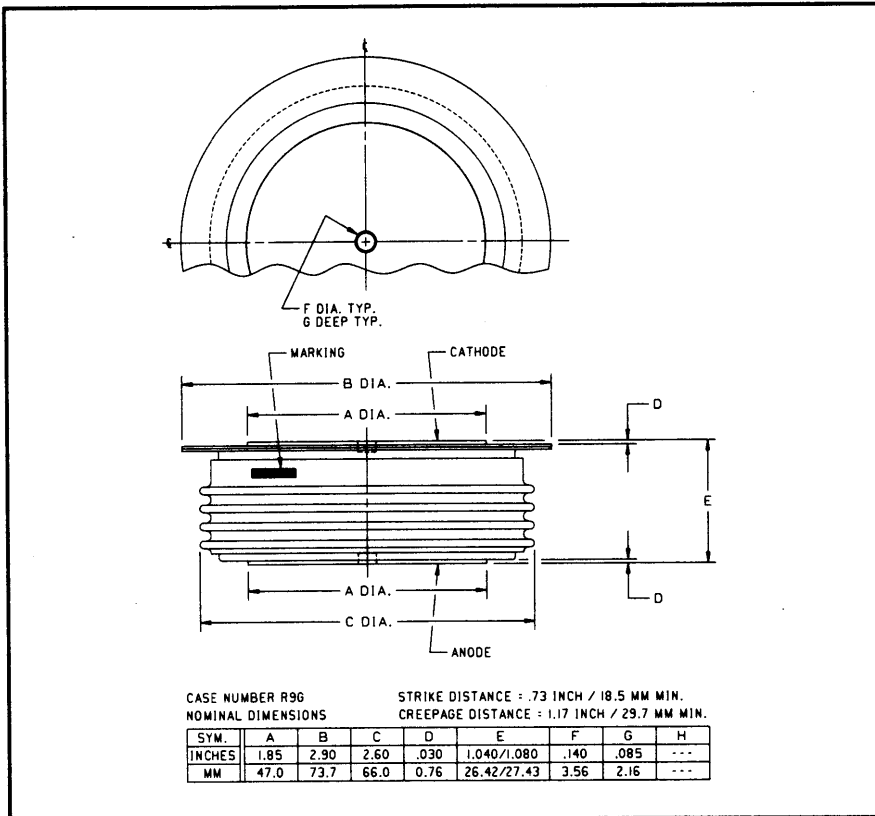

R9G2_12
Fast Recovery Rectifier
 1200 Amperes Average, 3600 Volts

R9G2_12 (Outline Drawing)

Ordering Information:

Select the complete part number you desire from the following table:

Type	Voltage		Current		Recovery Time		Leads	
	V _{RRM} (Volts)	Code	I _{F(av)} (A)	Code	t _{rr} (μsec)	Code	Case	Code
R9G2	400	04	1200	12	4.0	BS	R9G2	OO
	600	06						
	800	08						
	1000	10						
	1200	12						
	1400	14						
	1600	16						
	1800	18						
	2000	20						
	2200	22						
	2400	24						
	2600	26						
	2800	28						
	3000	30						
	3200	32						
	3400	34						
	3600	36						

Features:

- Fast Recovery Times
- Soft Recovery Characteristics
- High Surge Current Ratings
- Special Selection of t_{rr} or Q_{rr} available

Applications:

- Inverters
- Choppers
- Transmitters
- Free Wheeling Diode

Example: Type R9G2 rated at 1200A average with V_{RRM} = 3600V,
 Recovery Time = 4.0 μsec, order as:

Type	Voltage	Current	Time	Leads
R 9 G 2	3 6	1 2	BS	O O



Powerex, Inc., 200 Hillis Street, Youngwood, Pennsylvania 15697-1800 (412) 925-7272
 Powerex, Europe, S.A. 428 Avenue G. Durand, BP107, 72003 Le Mans, France (43) 41.14.14

R9G2_12

Fast Recovery Rectifier

1200 Amperes Average, 3600 Volts

Absolute Maximum Ratings

Characteristics	Symbol	R9G2_12	Units
RMS Forward Current	$I_{F(rms)}$	1900	Amperes
Average Forward Current	$I_{F(av)}$	1200	Amperes
One-half Cycle Surge Current	I_{FSM}	14000	Amperes
i^2t (for Fusing), Times \geq 8.3 milliseconds	i^2t	820000	A^2sec
Max. i^2t Package (for Times = 8.3 milliseconds)	i^2t	90×10^6	A^2sec
Storage Temperature	T_{stg}	-40 to +190	$^{\circ}C$
Operating Temperature	T_j	-40 to +150	$^{\circ}C$
Mounting Force		5000 to 6000	lbs

Electrical and Thermal Characteristics

Characteristics	Symbol	Test Conditions	R9G2_12	Units
Current - Conducting State Maximums				
Forward Voltage Drop	V_{FM}	$T_j = 25^{\circ}C, I_{FM} = 1500A$	2.30	Volts
Voltage - Blocking State Maximums				
Repetitive Peak Reverse Voltage (Rated Limit)	V_{RRM}		3600	Volts
Non-rep. Trans. Peak Rev. Voltage (Rated Limit)	V_{RSM}	$V \leq 5.0msec$	3800	Volts
Reverse Leakage Current, mA peak	I_{RRM}	T_j at max., $V_{RRM} = \text{Rated}$	75	mA
Switching				
Maximum Reverse Recovery Time	t_{rr}	$I_{FM} = 1500A, t_p = 190\mu sec,$ $di_F/dt = 25A/\mu sec, T_C = 25^{\circ}C$	4.0	μsec
Thermal				
Maximum Resistance, Junction to Case	$R_{\theta(j-c)}$		0.018	$^{\circ}C/Watt$
Maximum Resistance, Case to Sink (Lubricated)	$R_{\theta(c-s)}$		0.0075	$^{\circ}C/Watt$

Powerex, Inc., 200 Hillis Street, Youngwood, Pennsylvania 15697-1800 (412) 925-7272
 Powerex, Europe, S.A. 428 Avenue G. Durand, BP107, 72003 Le Mans, France (43) 41.14.14

R9G2_12
 Fast Recovery Rectifier
 1200 Amperes Average, 3600 Volts

Reverse Recovery Wave Form

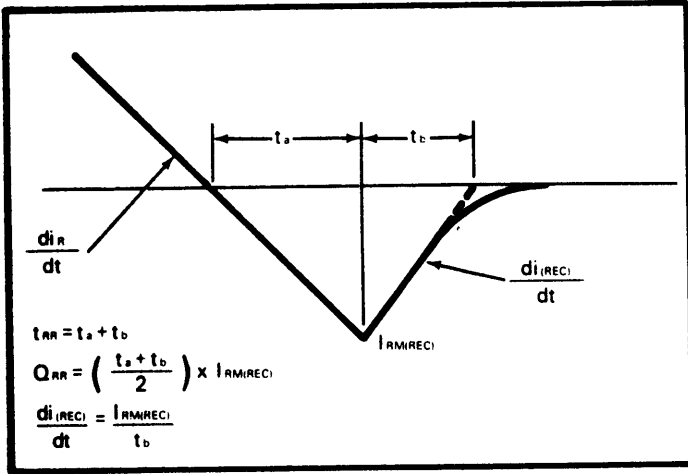

Typical Reverse Recovery Time vs. Rate of Current Fall

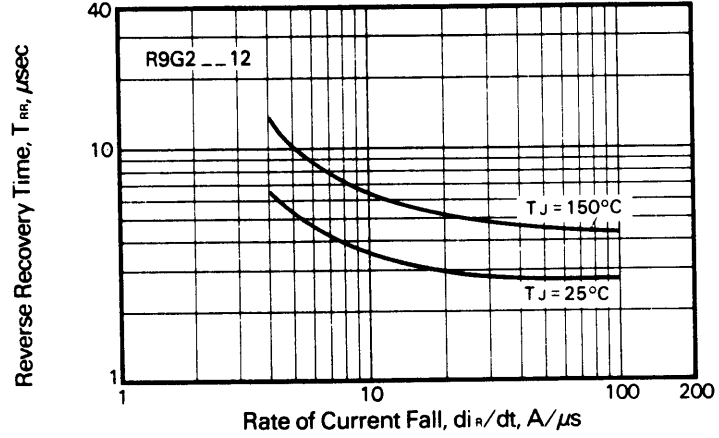

Typical Reverse Recovery Charge vs. Rate of Current Fall

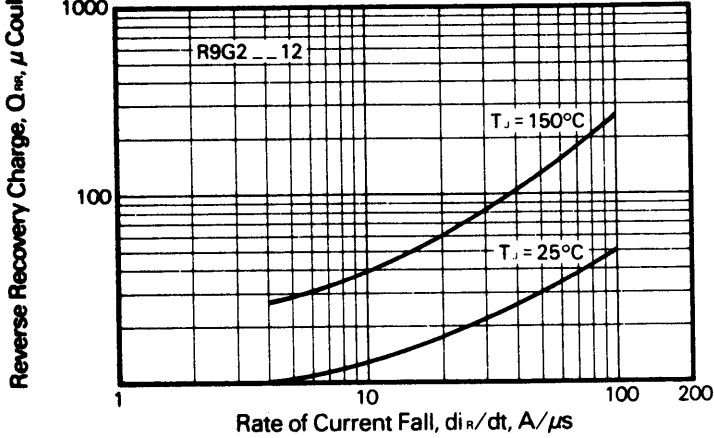

Typical Ratio of Current Recovery to Rate of Current Fall

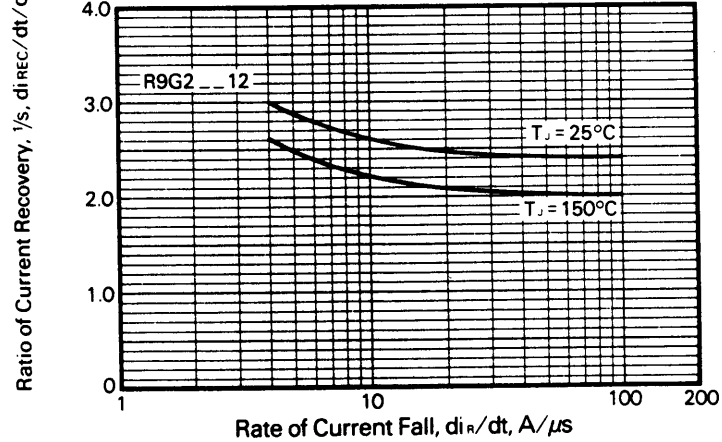

R9G2_12
Fast Recovery Rectifier
 1200 Amperes Average, 3600 Volts

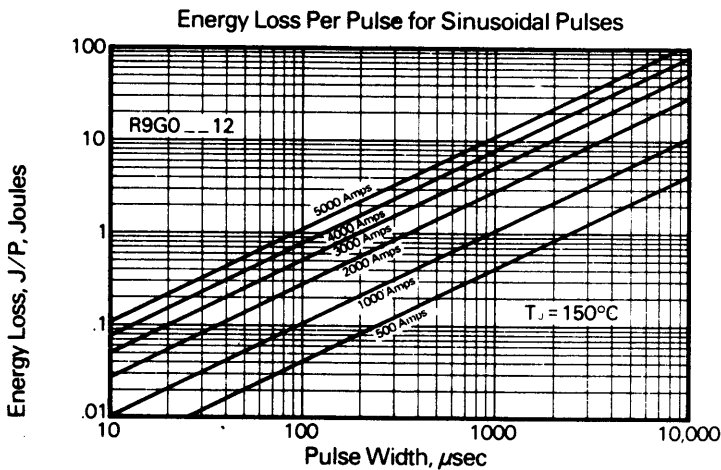
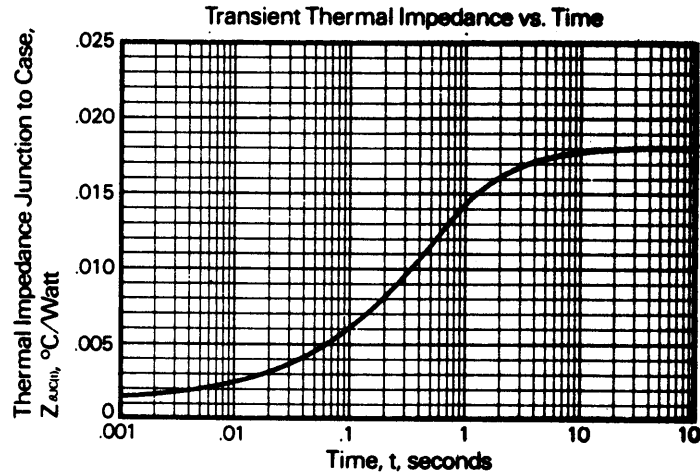
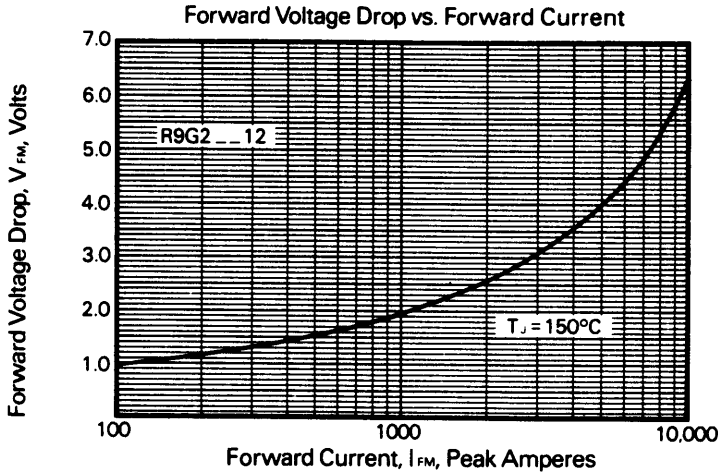

Calculation of Fast Recovery Diodes and Allowable Case Temperature

1. Conduction Losses
 $P_{av(cond)} = J/P \times F$
2. Reverse Recovery Losses (Approximate)
 $P_{av(sw)} = 1/4 \times V_R \times \frac{di_R}{dt} \times T_{rr}^2 \times \left(\frac{1/s}{1 + 1/s}\right)^2 \times F \times 1 \times 10^{-6}$
3. Maximum Allowable Case Temperature
 $T_{C(max)} = T_j - (P_{av(cond)} + P_{av(sw)} \times R_{\theta(j-c)})$
 Where:
 $P_{av(cond)}$ = Forward Conduction Power Loss in Watts
 $P_{av(sw)}$ = Reverse Recovery Power Loss in Watts
 J/P = Energy Loss per Pulse in Joules
 F = Frequency in Hertz
 V_R = Steady State Reverse Operating Voltage in Volts
 di_R/dt = Rate of Decay of Forward Current in Amperes/ μsec
 T_{rr} = Reverse Recovery Time in Microseconds
 $\frac{1}{"S"}$ = Ratio of Recovery di/dt ($\frac{di_F/dt}{di_R/dt}$)
 F = Operating Frequency in Hertz
 $T_{C(max)}$ = Maximum Allowable Case Temperature in $^\circ\text{C}$.
 T_j = Maximum Operating Junction Temperature in $^\circ\text{C}$.
 $R_{\theta(j-c)}$ = DC Junction to Case Thermal Impedance in $^\circ\text{C/Watt}$.