

Powerex, Inc., 200 Hillis Street, Youngwood, Pennsylvania 15697-1800 (412) 925-7272
 Powerex, Europe, S.A. 428 Avenue G. Durand, BP107, 72003 Le Mans, France (43) 41.14.14

General Purpose Rectifier

1200 Amperes Average
5400 Volts

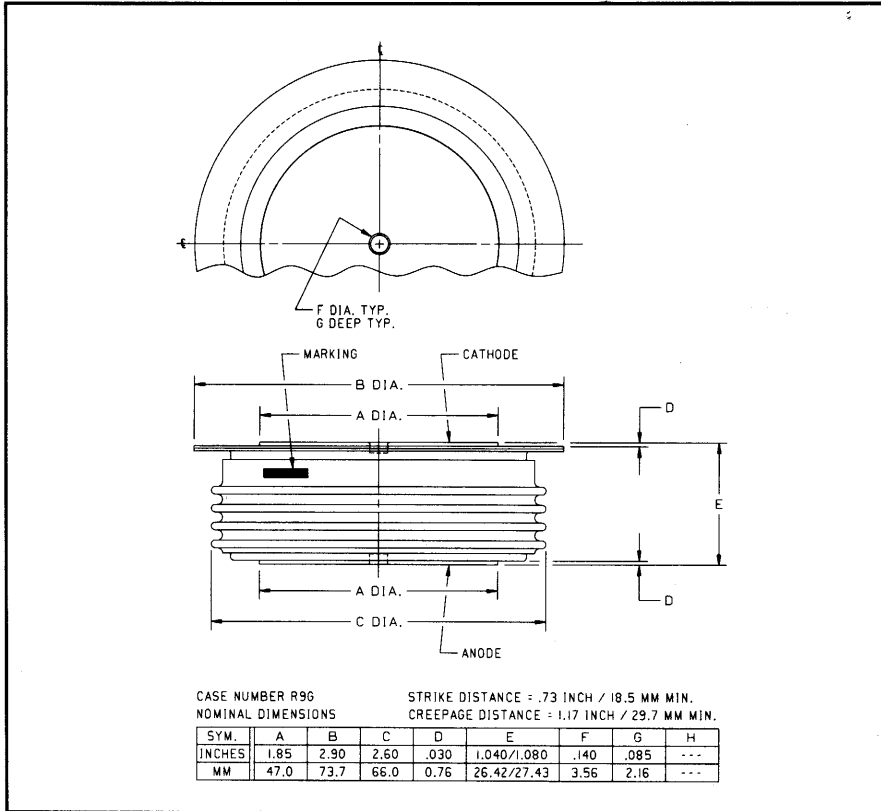

R9G0 1200A (Outline Drawing)

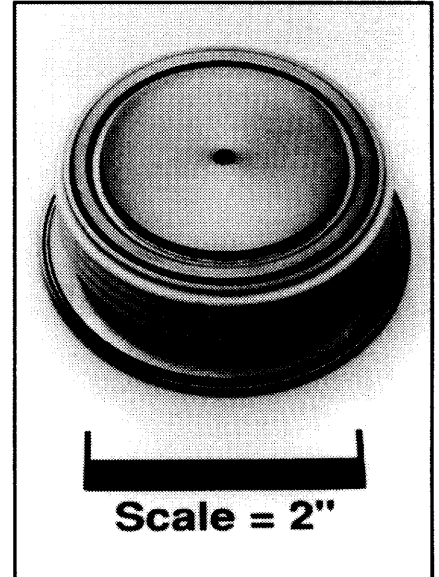

R9G0 1200A General Purpose Rectifier
 1200 Amperes Average, 5400 Volts

Description:

Powerex General Purpose Rectifiers are designed for high blocking voltage capability with low forward voltage to minimize conduction losses. These hermetic Pow-R-Disc devices can be mounted using commercially available clamps and heatsinks.

Features:

- Low Forward Voltage
- Low Thermal Impedance
- Hermetic Packaging
- Excellent Surge and I^2t Ratings

Applications:

- Power Supplies
- Motor Control
- Free Wheeling Diode
- Battery Chargers
- Resistance Welding

Ordering Information:

Select the complete 8 digit part number you desire from the table below.

Type	Voltage	Current	Typical Recovery Time
	V_{RRM} (Volts)	$I_T(av)$ (A)	t_{rr} (μ sec)
R9G0	10 through 54	12	XX
	1000V through 5400V	1200A	25 μ sec



Powerex, Inc., 200 Hillis Street, Youngwood, Pennsylvania 15697-1800 (412) 925-7272
Powerex, Europe, S.A. 426 Avenue G. Durand, BP107, 72003 Le Mans, France (43) 41.14.14

R9G0 1200A
General Purpose Rectifier
1200 Amperes Average, 5400 Volts

Absolute Maximum Ratings

Characteristics	Symbol	R9G0 1200A	Units
Non-repetitive Transient Peak Reverse Voltage	V_{RSM}	$V_{RRM} + 200V$	Volts
RMS Forward Current, $T_C = 102^\circ C$	$I_{F(rms)}$	1880	Amperes
Average Current 180° Sine Wave, $T_C = 102^\circ C$	$I_{F(av)}$	1200	Amperes
RMS Forward Current, $T_C = 55^\circ C$	$I_{F(rms)}$	2640	Amperes
Average Current 180° Sine Wave, $T_C = 55^\circ C$	$I_{F(av)}$	1680	Amperes
Peak One Cycle Surge Forward Current (Non-repetitive) 60Hz	I_{fsm}	16000	Amperes
Peak One Cycle Surge Forward Current (Non-repetitive) 50Hz	I_{fsm}	14600	Amperes
3 Cycle Surge Current	I_{fsm}	12000	Amperes
10 Cycle Surge Current	I_{fsm}	10000	Amperes
I^2t (for Fusing) for One Cycle, 60Hz	I^2t	1,100,000	A^2sec
Maximum I^2t of Package ($t = 8.3$ msec)	I^2t	90×10^6	A^2sec
Operating Temperature	T_j	-40 to +190°C	°C
Storage Temperature	T_{stg}	-40 to +190°C	°C
Approximate Weight		1	lb.
		454	g
Mounting Force		5000 to 6000	lb.
		2270 to 2700	kg.

R9G0 1200A

General Purpose Rectifier
 1200 Amperes Average, 5400 Volts

Electrical Characteristics, $T_j = 25^\circ\text{C}$ Unless Otherwise Specified

Characteristics	Symbol	Test Conditions	Min.	Typ.	Max.	Units
Peak Reverse Leakage Current	I_{RRM}	$T_j = 125^\circ\text{C}, V_R = V_{RRM}$			150	mA
Forward Voltage Drop	V_{FM}	$I_{FM} = 1500\text{A}, \text{Duty Cycle} < 0.1\%$			1.45	Volts
Threshold Voltage, Low-level	$V_{(TO)1}$	$T_j = 190^\circ\text{C}, I = 15\%, I_{T(av)}$ to $\pi I_{T(av)}$			1.07197	Volts
Slope Resistance, Low-level	r_{T1}				0.32357	m Ω
Threshold Voltage, High-level	$V_{(TO)2}$	$T_j = 190^\circ\text{C}, I = \pi I_{T(av)}$ to I_{TSM}			1.32168	Volts
Slope Resistance, High-level	r_{T2}				0.28547	m Ω
V_{TM} Coefficients, Low-level		$T_j = 190^\circ\text{C}, I = 15\% I_{T(av)}$ to $\pi I_{T(av)}$				$A_1 = 1.35256$ $B_1 = -0.07539$ $C_1 = 2.5757\text{E-}04$ $D_1 = 9.591\text{E-}03$
V_{TM} Coefficients, High-level		$T_j = 190^\circ\text{C}, I = \pi I_{T(av)}$ to I_{TSM}				$A_2 = -4.04314$ $B_2 = 0.74639$ $C_2 = 2.726\text{E-}04$ $D_2 = -0.01249$
Typical Reverse Recovery Time	t_{rr}	$T_C = 25^\circ\text{C}, I_{FM} = 1500\text{A},$ $di_F/dt = 25\text{A}/\mu\text{sec}, t_p = 190\mu\text{sec}$		25		μsec

Thermal Characteristics

Maximum Thermal Resistance, Double Sided Cooling						
Junction-to-Case	$R_{\theta(j-c)}$				0.020	$^\circ\text{C}/\text{W}$
Case-to-Sink	$R_{\theta(c-s)}$				0.0075	$^\circ\text{C}/\text{W}$



Powerex, Inc., 200 Hillis Street, Youngwood, Pennsylvania 15697-1800 (412) 925-7272
 Powerex, Europe, S.A. 428 Avenue G. Durand, BP107, 72003 Le Mans, France (43) 41.14.14

R9G0 1200A
 General Purpose Rectifier
 1200 Amperes Average, 5400 Volts

Maximum On-State Forward Voltage Drop
 ($T_J = 150^\circ\text{C}$)

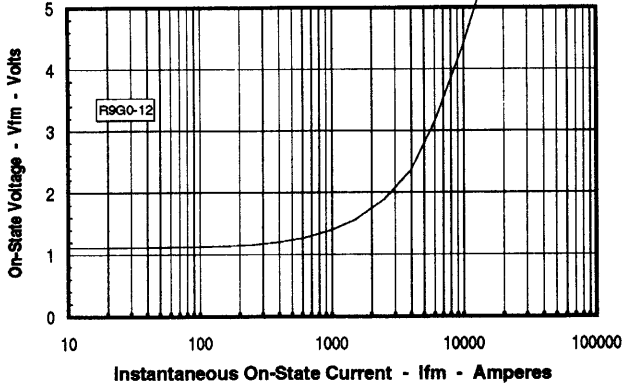

Maximum Transient Thermal Impedance
 (Junction to Case)

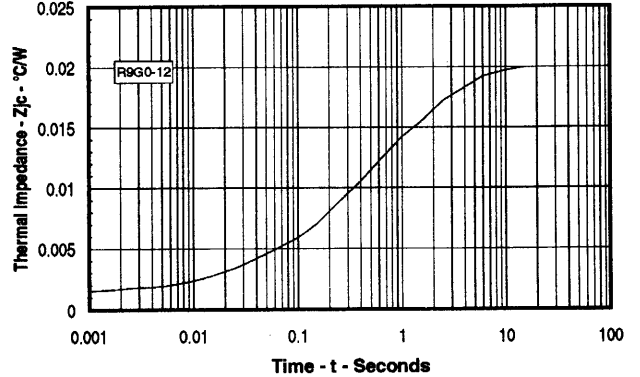

Maximum On-State Power Dissipation
 (Sinusoidal Waveform)

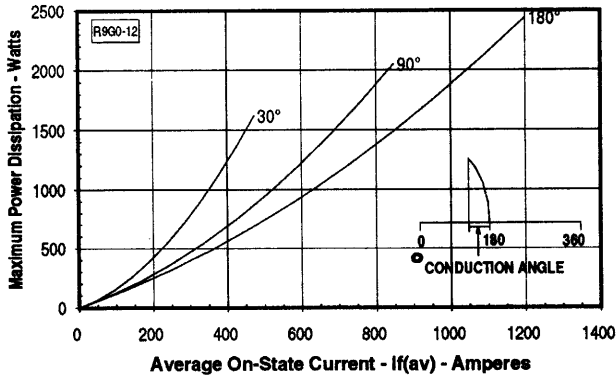

Maximum Allowable Case Temperature
 (Sinusoidal Waveform)

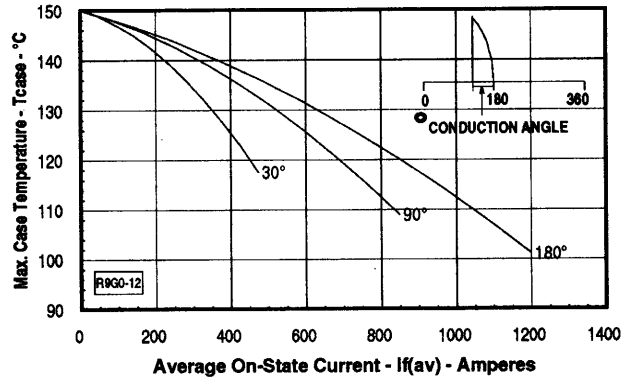

Maximum On-State Power Dissipation
 (Rectangular Waveform)

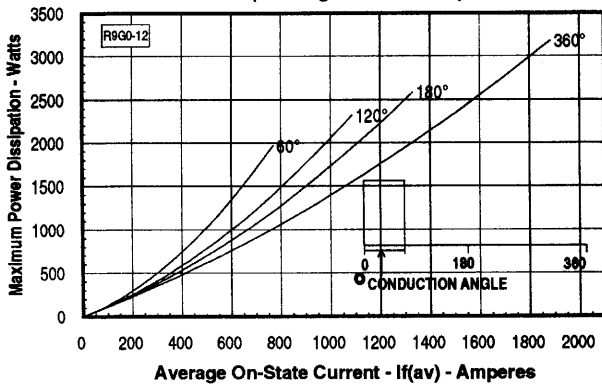

Maximum Allowable Case Temperature
 (Rectangular Waveform)

