

Powerex, Inc., 200 Hillis Street, Youngwood, Pennsylvania 15697-1800 (412) 925-7272
 Powerex, Europe, S.A. 428 Avenue G. Durand, BP107, 72003 Le Mans, France (43) 41.14.14

Fast Recovery Rectifier
 1000 Amperes Average
 1600 Volts

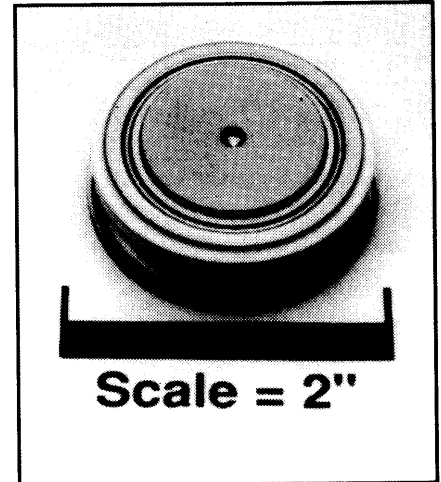
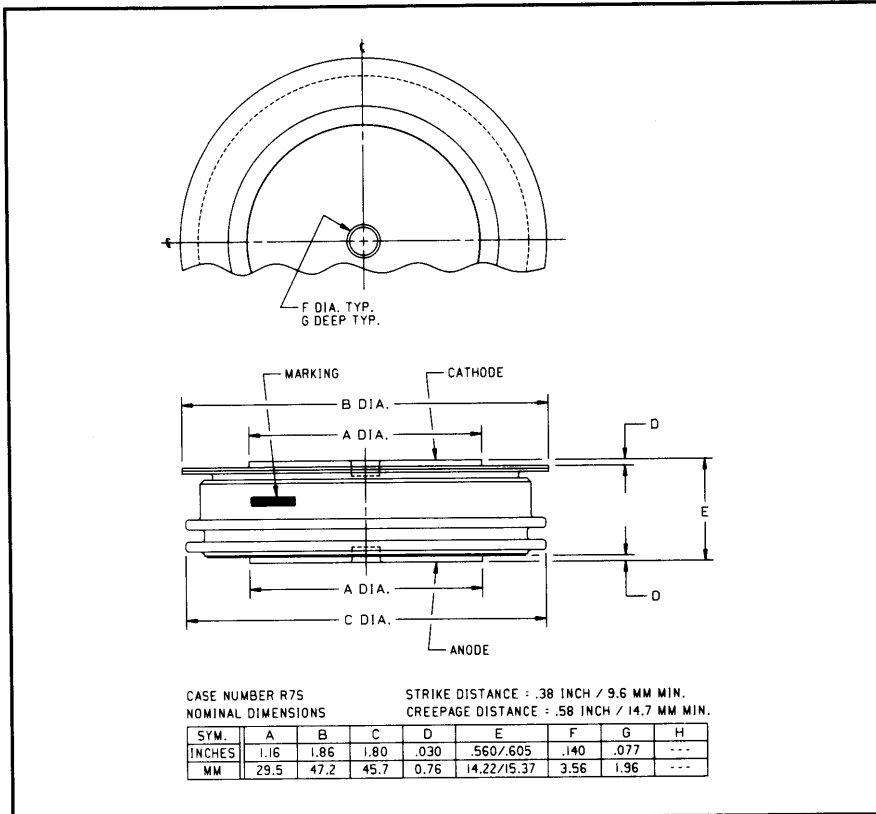

R7S2_10
 Fast Recovery Rectifier
 1000 Amperes Average, 1600 Volts

R7S2_10 (Outline Drawing)

Ordering Information:

Select the complete part number you desire from the following table:

Type	Voltage		Current		Recovery Time		Leads	
	V _{RRM} (Volts)	Code	I _{F(av)} (A)	Code	t _{rr} (μsec)	Code	Case	Code
R7S2	400	04	1000	10	2.0	ES	R7S	OO
	600	06						
	800	08						
	1000	10						
	1200	12						
	1400	14						
	1600	16						

Example: Type R7S2 rated at 1000A average with V_{RRM} = 1600V,
 Recovery Time = 2.0 μsec, order as:

Type	Voltage	Current	t _{rr}	Leads
R 7 S 2	1 2	1 0	ES	O O

Features:

- Fast Recovery Times
- Soft Recovery Characteristics
- High Surge Current Ratings
- Special Selection of t_{rr} and Q_{rr} available
- Low Thermal Impedance
- Low Profile Package

Applications:

- Inverters
- Choppers
- Transmitters
- Free Wheeling Diode

R7S2__10

Fast Recovery Rectifier

1000 Amperes Average, 1600 Volts

Absolute Maximum Ratings

Characteristics	Symbol	R7S2__10	Units
RMS Forward Current	$I_F(\text{rms})$	1550	Amperes
Average Forward Current	$I_F(\text{av})$	1000	Amperes
One-half Cycle Surge Current	I_{FSM}	11,000	Amperes
I^2t (for Fusing), Times = 8.3 milliseconds	I^2t	504000	$A^2\text{sec}$
Max. I^2t Package (for Times = 8.3 milliseconds)	I^2t	50×10^6	$A^2\text{sec}$
Storage Temperature	T_{stg}	-40 to +190	$^{\circ}\text{C}$
Operating Temperature	T_j	-40 to +150	$^{\circ}\text{C}$
Mounting Force		2000 to 2400	lbs

Electrical and Thermal Characteristics

Characteristics	Symbol	Test Conditions	R7S2__10	Units
Current - Conducting State Maximums				
Forward Voltage Drop	V_{FM}	$T_j = 25^{\circ}\text{C}, V_{IFM} = 1500\text{A}$	1.65	Volts
Voltage - Blocking State Maximums				
Repetitive Peak Reverse Voltage (Rated Limit)	V_{RRM}		1400	Volts
Non-rep. Trans. Peak Rev. Voltage (Rated Limit)	V_{RSM}	$t \leq 5.0\text{msec}$	1600	Volts
Reverse Leakage Current, mA peak	I_{RRM}	T_j at max., $V_{RRM} = \text{Rated}$	50	mA
Switching				
Maximum Reverse Recovery Time	t_{rr}	$I_{FM} = 1500, t_p = 190 \mu\text{sec},$ $di_F/dt = 25\text{A}/\mu\text{sec}, T_C = 25^{\circ}\text{C}$	2.0	μsec
Thermal				
Maximum Resistance, Junction to Case	$R_{\theta(j-c)}$		0.035	$^{\circ}\text{C}/\text{Watt}$
Maximum Resistance, Case to Sink (Lubricated)	$R_{\theta(c-s)}$		0.020	$^{\circ}\text{C}/\text{Watt}$

Powerex, Inc., 200 Hillis Street, Youngwood, Pennsylvania 15697-1800 (412) 925-7272
 Powerex, Europe, S.A. 428 Avenue G. Durand, BP107, 72003 Le Mans, France (43) 41.14.14

R7S2_10
Fast Recovery Rectifier
 1000 Amperes Average, 1600 Volts

Reverse Recovery Wave Form

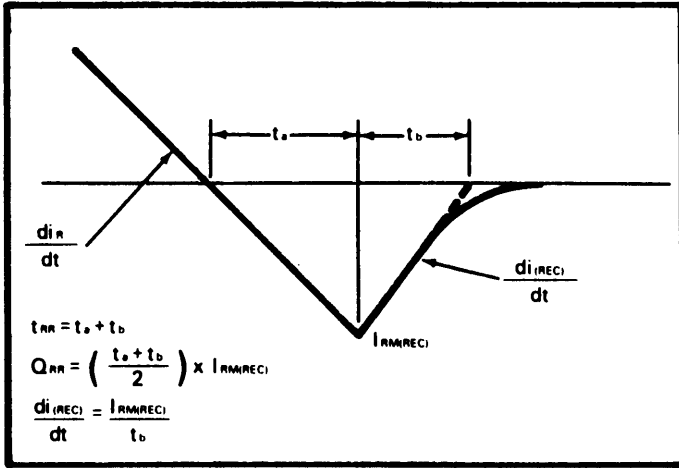

Typical Reverse Recovery Time Vs. Rate of Current Fall

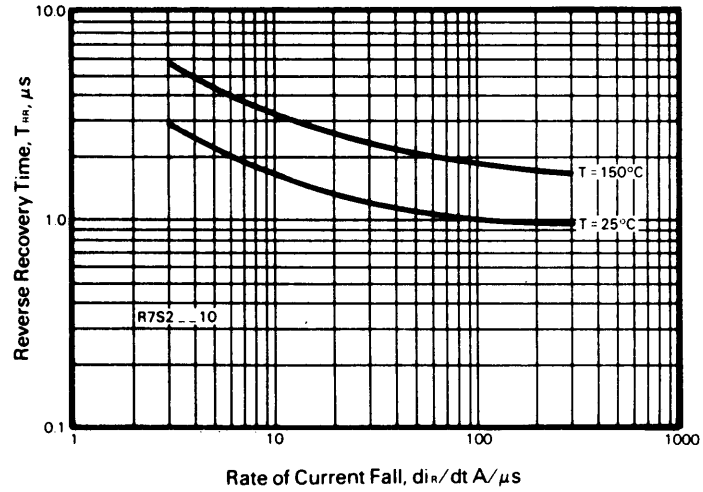

Typical Reverse Recovery Charge Vs. Rate of Current Fall

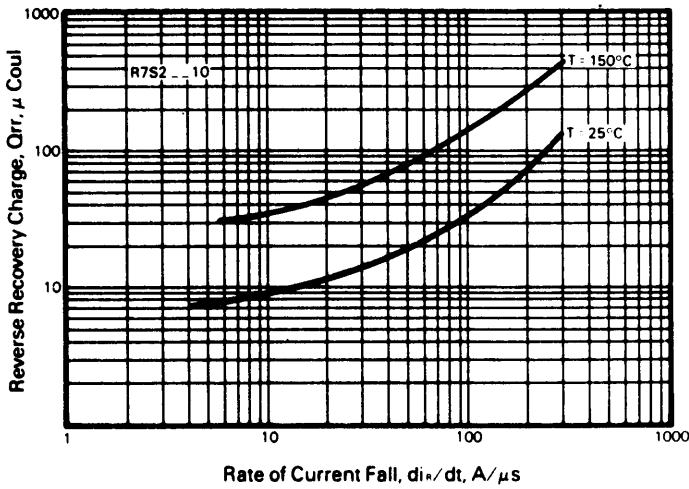

Typical Ratio of Current Recovery to Rate of Current Fall

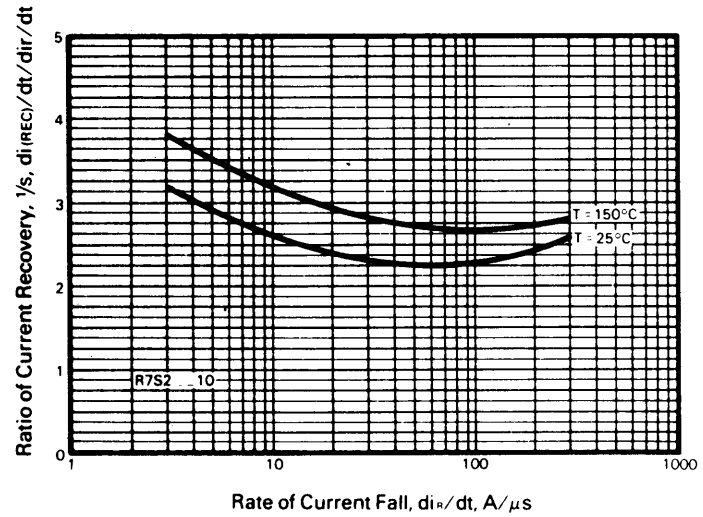

Powerex, Inc., 200 Hillis Street, Youngwood, Pennsylvania 15697-1800 (412) 925-7272
 Powerex, Europe, S.A. 428 Avenue G. Durand, BP107, 72003 Le Mans, France (43) 41.14.14

R7S2 _10

Fast Recovery Rectifier

1000 Amperes Average, 1600 Volts

Forward Current Vs. Forward Voltage Drop

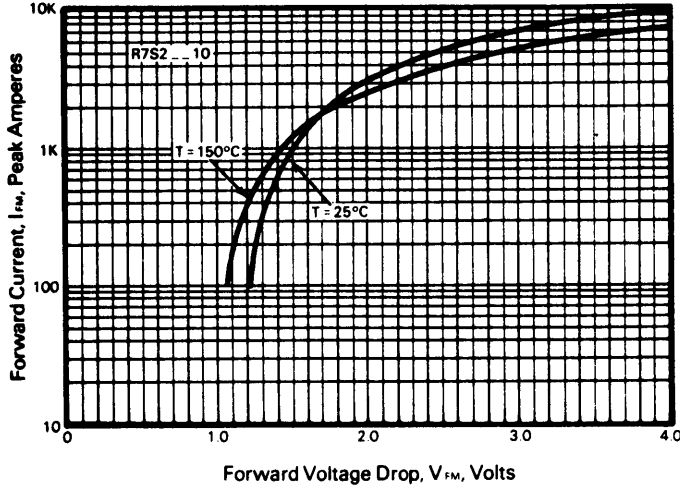

Transient Thermal Impedance Vs. Time

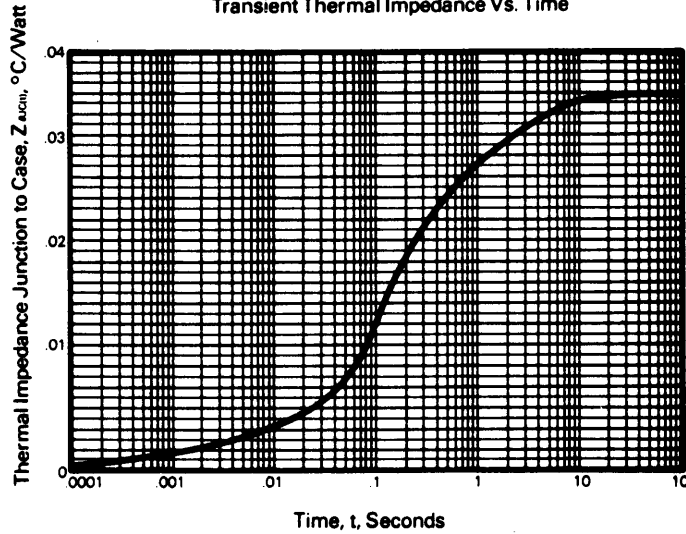

Energy Loss Per Pulse for Sinusoidal Pulses

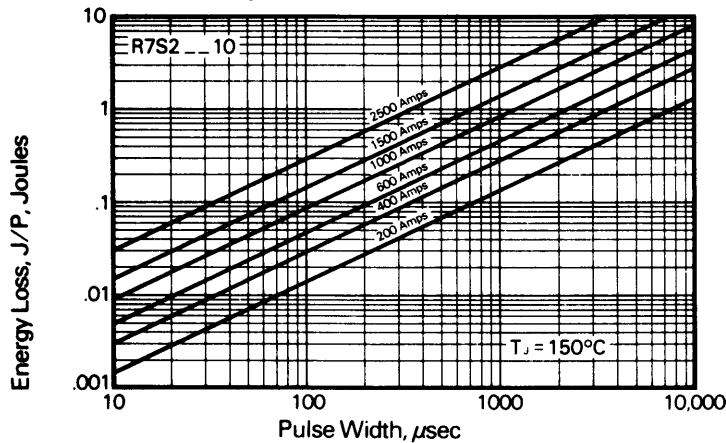

Calculation of Fast Recovery Diodes and Allowable Case Temperature

1. Conduction Losses

$$P_{av(cond)} = J/P \times F$$

2. Reverse Recovery Losses (Approximate)

$$P_{av(sw)} = 1/4 \times V_R \times \frac{di_R}{dt} \times T_{rr}^2 \times \left(\frac{1/s}{1 + 1/s} \right)^2 \times F \times 1 \times 10^{-6}$$

3. Maximum Allowable Case Temperature

$$T_{C(max)} = T_j - (P_{av(cond)} + P_{av(sw)} \times R_{\theta(j-c)})$$

Where:

$P_{av(cond)}$ = Forward Conduction Power Loss in Watts

$P_{av(sw)}$ = Reverse Recovery Power Loss in Watts

J/P = Energy Loss per Pulse in Joules

F = Frequency in Hertz

V_R = Steady State Reverse Operating Voltage in Volts

di_R/dt = Rate of Decay of Forward Current in Amperes/ μsec

T_{rr} = Reverse Recovery Time in Microseconds

$\frac{1}{"S"}$ = Ratio of Recovery $di/dt \left(\frac{di_F/dt}{di_R/dt} \right)$

F = Operating Frequency in Hertz

$T_{C(max)}$ = Maximum Allowable Case Temperature in $^\circ\text{C}$.

T_j = Maximum Operating Junction Temperature in $^\circ\text{C}$.

$R_{\theta(j-c)}$ = DC Junction to Case Thermal Impedance in $^\circ\text{C/Watt}$.