

Powerex, Inc., 200 Hillis Street, Youngwood, Pennsylvania 15697-1800 (412) 925-7272  
 Powerex, Europe, S.A. 428 Avenue G. Durand, BP107, 72003 Le Mans, France (43) 41.14.14

**General Purpose Rectifier**  
**600-1200 Amperes**  
**4400 Volts**

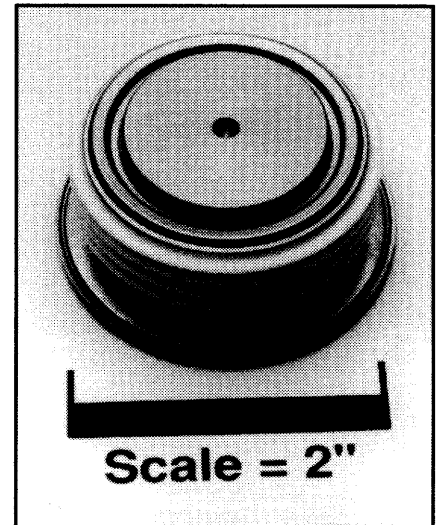
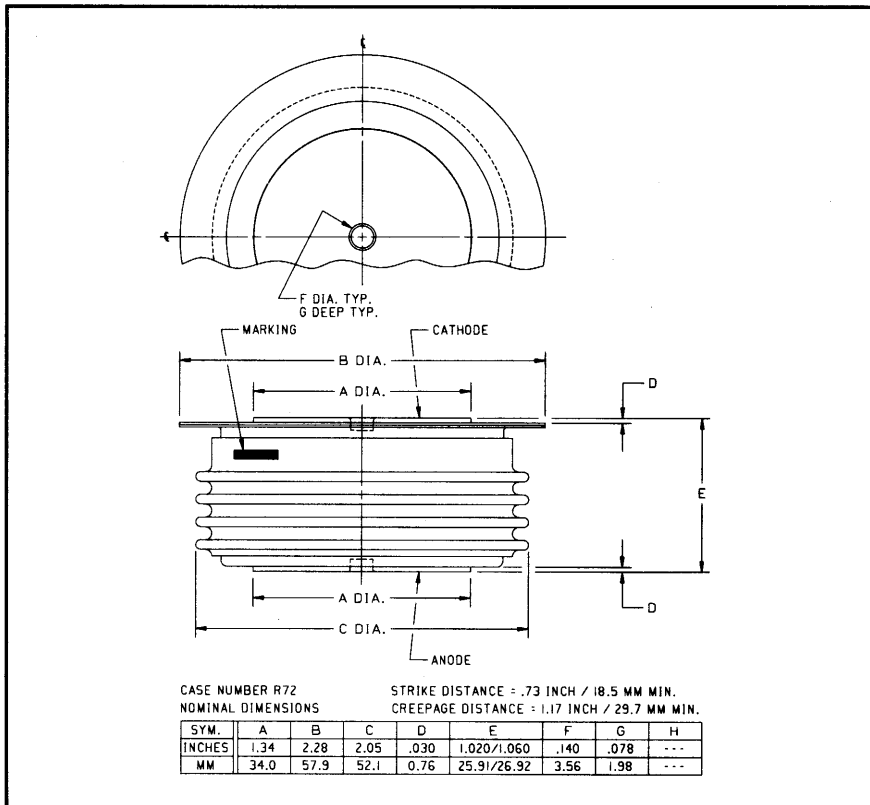

**R720**  
**General Purpose Rectifier**  
 600-1200 Amperes, 4400 Volts

R720 (Outline Drawing)

**Ordering Information:**

Select the complete part number you desire from the following table:

Type	Voltage		Current		Recovery Time		Recovery Time Circuit		Leads	
	$V_{RRM}$ (Volts)	Code	$I_{F(av)}$ (A)	Code	$t_{rr}$ ( $\mu$ sec)	Code	Circuit	Code	Case	Code
R720	100	01	600	06	13	X	JEDEC	X	R72	OO
	200	02								
	400	04	900	09	10					
	600	06								
	800	08	1200	12	7					
	1000	10			(Typical)					
	1200	12								
	1400	14								
	1600	16								
	1800	18								
	2000	20								
	2200	22								
	2400	24								
	2600	26								
	2800	28								
	3000	30								
	3500	35								
	4000	40								
	4400	44								

Example: Type R720 rated at 900A average with  $V_{RRM} = 2600V$

Type	Voltage	Current	Time	Circuit	Leads
R 7 2 0	2 6	0 9	X	X	O O

**Features:**

- High Surge Current Ratings
- High Rated Blocking Voltages
- Special Electrical Selection for Parallel and Series Operation
- Single or Double-sided Cooling
- Long Creepage & Strike Paths
- Hermetic Seal

**Applications:**

- Rectification
- Free Wheeling Diode
- Battery Chargers
- Resistance Welding



Powerex, Inc., 200 Hillis Street, Youngwood, Pennsylvania 15697-1800 (412) 925-7272  
 Powerex, Europe, S.A. 428 Avenue G. Durand, BP107, 72003 Le Mans, France (43) 41.14.14

**R720**  
**General Purpose Rectifier**  
 600-1200 Amperes, 4400 Volts

### Absolute Maximum Ratings

Characteristics	Symbol	R720_06	R720_09	R720_12	Units
RMS Forward Current	$I_F(\text{rms})$	945	1415	1885	Amperes
Average Forward Current	$I_F(\text{av})$	600	900	1200	Amperes
One-half Cycle Surge Current	$I_{FSM}$	7000	8500	12500	Amperes
3 Cycle Surge Current	$I_{FSM}$	5250	6350	9400	Amperes
10 Cycle Surge Current	$I_{FSM}$	4350	5300	7800	Amperes
$I^2t$ (for Fusing), Times = 8.3 milliseconds	$I^2t$	204000	301000	650700	$A^2\text{sec}$
Max. $I^2t$ of Package (t = 8.3ms)	$I^2t$	$80 \times 10^6$	$80 \times 10^6$	$80 \times 10^6$	$A^2\text{sec}$
Storage Temperature	$T_{stg}$	-65 to +200	-65 to +200	-65 to +200	$^{\circ}\text{C}$
Operating Temperature	$T_j$	Up to 1400V -65 to +200	1400V to 2200V -65 to +175	2200V to 4600V -65 to +150	$^{\circ}\text{C}$
Mounting Force		2000 to 2400	2000 to 2400	2000 to 2400	lbs

### Electrical and Thermal Characteristics

Characteristics	Symbol	Test Conditions	R720_06	R720_09	R720_12	Units
<b>Current - Conducting State Maximums</b>						
Forward Voltage Drop	$V_{FM}$	$T_j = 25^{\circ}\text{C}$ , $I_{FM} = 1500\text{A}$	2.15	1.60	1.20	Volts
<b>Voltage - Blocking State Maximums</b>						
Repetitive Peak Reverse Voltage (Rated Limit)	$V_{RRM}$		4400	2600	1600	Volts
Non-rep. Trans. Peak Rev. Voltage (Rated Limit)	$V_{RSM}$	$t \leq 5.0\mu\text{sec}$	4600	2800	1800	Volts
Reverse Leakage Current	$I_{RRM}$	$T_j$ at max., $V_{RRM}$ Rated	50	50	50	mA
<b>Switching</b>						
Typical Reverse Recovery Time	$t_{rr}$	$I_{FM} = 1500\text{A}$ , $t_p = 190\mu\text{sec}$ , $di_F/dt = 25\text{A/msec}$ , $T_C = 25^{\circ}\text{C}$	Up to 1400V 7	1400V to 2200V 10	2200V to 4600V 13	$\mu\text{sec}$
<b>Thermal</b>						
Maximum Resistance, Double-sided Cooling, Junction to Case	$R_{\theta(j-c)}$		0.055	0.055	0.055	$^{\circ}\text{C/Watt}$
Maximum Resistance, Case to Sink (Lubricated)	$R_{\theta(c-s)}$		0.02	0.02	0.02	$^{\circ}\text{C/Watt}$



Powerex, Inc., 200 Hillis Street, Youngwood, Pennsylvania 15697-1800 (412) 925-7272  
 Powerex, Europe, S.A. 428 Avenue G. Durand, BP107, 72003 Le Mans, France (43) 41.14.14

**R720**  
**General Purpose Rectifier**  
 600-1200 Amperes, 4400 Volts

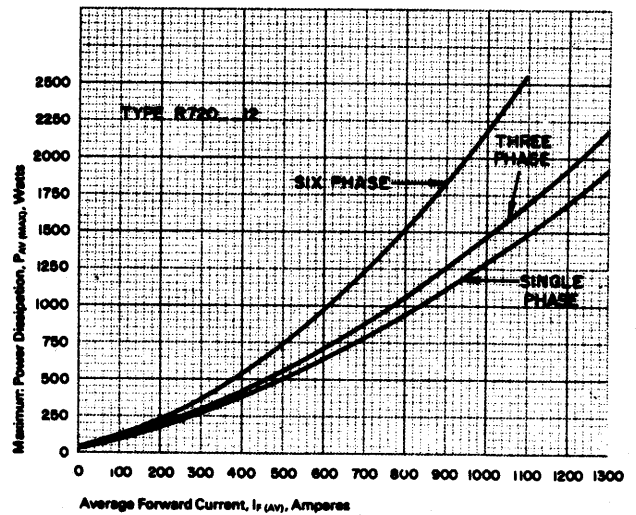
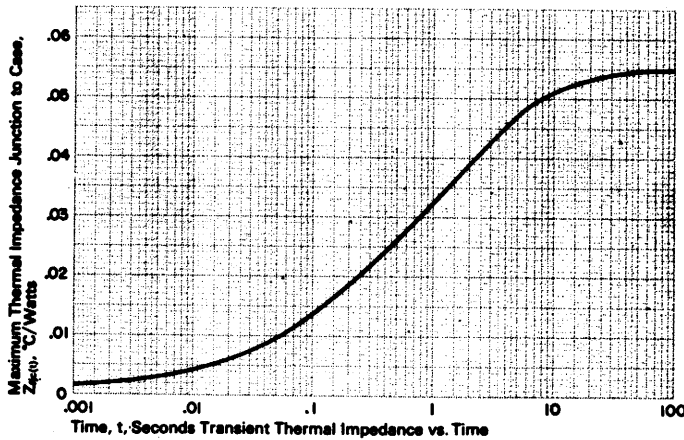
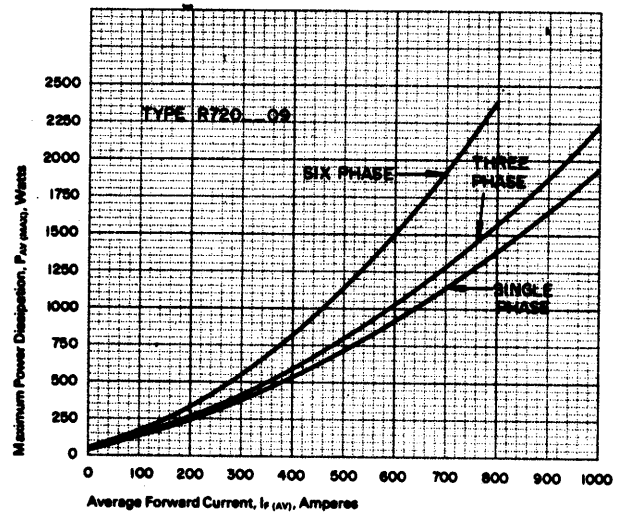
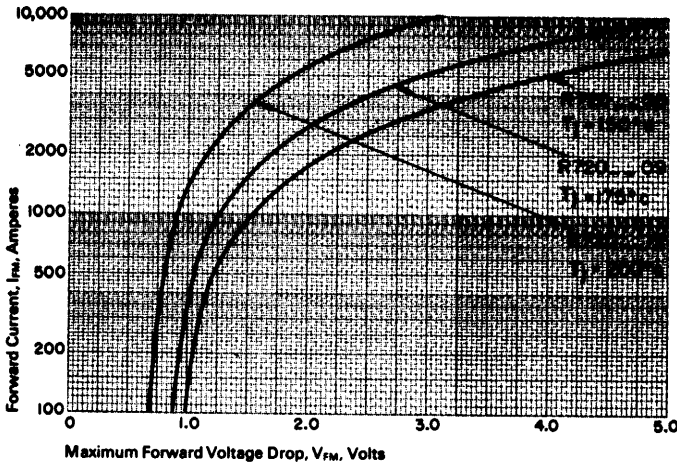
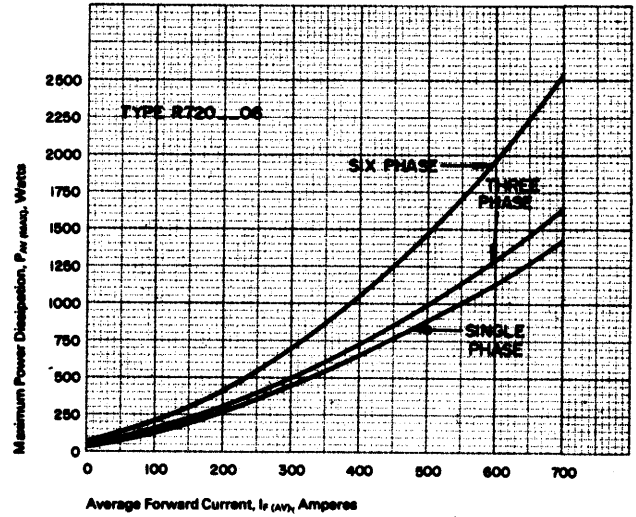
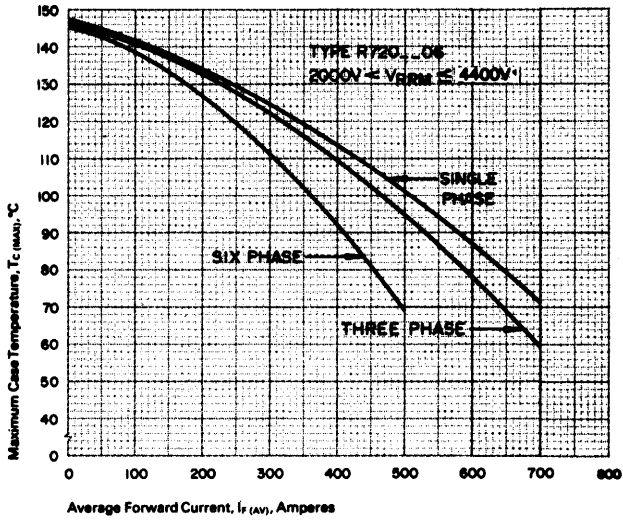

Powerex, Inc., 200 Hillis Street, Youngwood, Pennsylvania 15697-1800 (412) 925-7272  
 Powerex, Europe, S.A. 428 Avenue G. Durand, BP107, 72003 Le Mans, France (43) 41.14.14

**R720**  
**General Purpose Rectifier**  
 600-1200 Amperes, 4400 Volts

