

MITSUBISHI TRANSISTOR MODULES

# QM800HA-24B

HIGH POWER SWITCHING USE  
INSULATED TYPE

QM800HA-24B

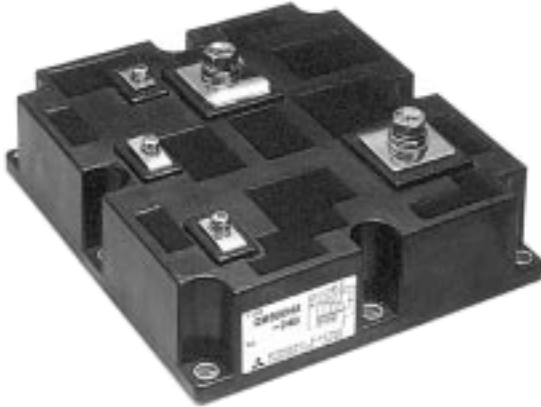

- **I<sub>C</sub>** Collector current ..... **800A**
- **V<sub>CEX</sub>** Collector-emitter voltage ..... **1200V**
- **h<sub>FE</sub>** DC current gain ..... **750**
- **Insulated Type**
- **UL Recognized**

Yellow Card No. E80276 (N)  
File No. E80271

## APPLICATION

AC motor controllers, UPS, CVCF, DC motor controllers, NC equipment, Welders

## OUTLINE DRAWING & CIRCUIT DIAGRAM

Dimensions in mm

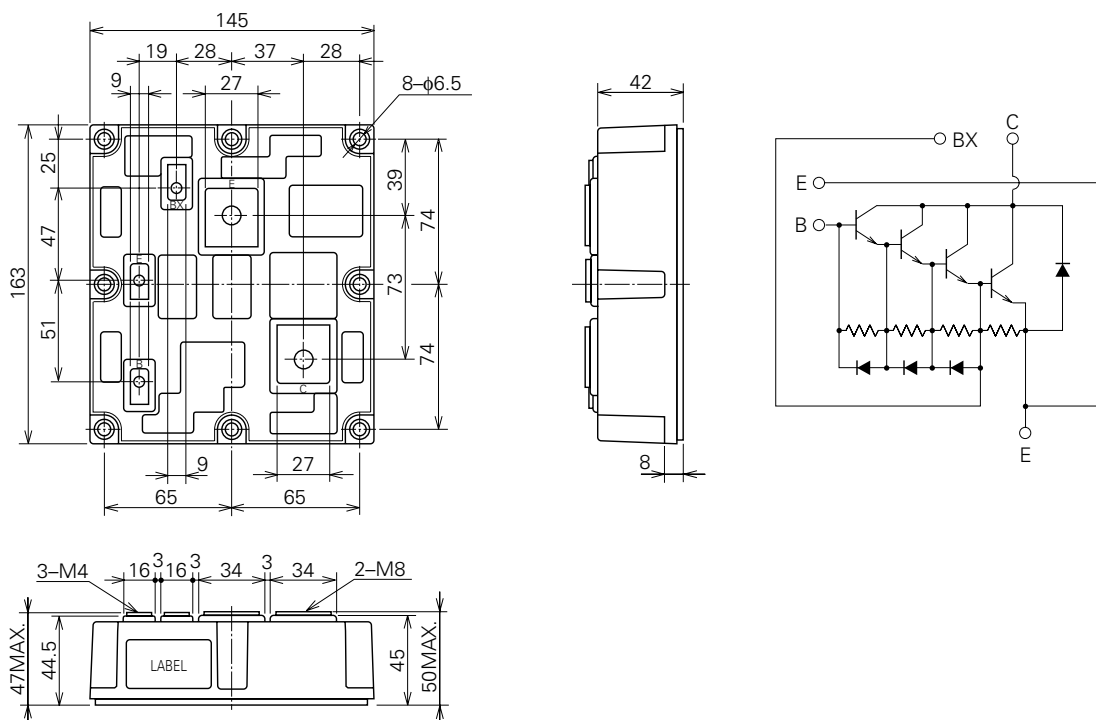

**QM800HA-24B**

**HIGH POWER SWITCHING USE  
INSULATED TYPE**

**ABSOLUTE MAXIMUM RATINGS** (T<sub>j</sub>=25°C, unless otherwise noted)

Symbol	Parameter	Conditions	Ratings	Unit
V <sub>CEX(SUS)</sub>	Collector-emitter voltage	I <sub>C</sub> =1A, V <sub>EB</sub> =2V	1200	V
V <sub>CEX</sub>	Collector-emitter voltage	V <sub>EB</sub> =2V	1200	V
V <sub>CBO</sub>	Collector-base voltage	Emitter open	1200	V
V <sub>EBO</sub>	Emitter-base voltage	Collector open	7	V
I <sub>C</sub>	Collector current	DC	800	A
-I <sub>C</sub>	Collector reverse current	DC (forward diode current)	800	A
P <sub>C</sub>	Collector dissipation	T <sub>C</sub> =25°C	5300	W
I <sub>B</sub>	Base current	DC	40	A
-I <sub>CSM</sub>	Surge collector reverse current (forward diode current)	Peak value of one cycle of 60Hz (half wave)	8000	A
T <sub>j</sub>	Junction temperature		-40~+150	°C
T <sub>stg</sub>	Storage temperature		-40~+125	°C
V <sub>iso</sub>	Isolation voltage	Charged part to case, AC for 1 minute	2500	V
—	Mounting torque	Main terminal screw M8	8.83~10.8	N·m
			90~110	kg·cm
		Mounting screw M6	1.96~2.94	N·m
			20~30	kg·cm
		B(E) terminal screw M4	0.98~1.47	N·m
			12~18	kg·cm
BX terminal screw M4	0.98~1.47	N·m		
	12~18	kg·cm		
—	Weight	Typical value	2100	g

**ELECTRICAL CHARACTERISTICS** (T<sub>j</sub>=25°C, unless otherwise noted)

Symbol	Parameter	Test conditions	Limits			Unit
			Min.	Typ.	Max.	
I <sub>C</sub> EX	Collector cutoff current	V <sub>CE</sub> =1200V, V <sub>EB</sub> =2V	—	—	8.0	mA
I <sub>C</sub> B	Collector cutoff current	V <sub>CB</sub> =1200V, Emitter open	—	—	8.0	mA
I <sub>E</sub> B	Emitter cutoff current	V <sub>EB</sub> =7V, Collector open	—	—	600	mA
V <sub>CE(sat)</sub>	Collector-emitter saturation voltage	I <sub>C</sub> =800A, I <sub>B</sub> =1.06A	—	—	4.0	V
V <sub>BE(sat)</sub>	Base-emitter saturation voltage		—	—	4.2	V
-V <sub>CEO</sub>	Collector-emitter reverse voltage	I <sub>C</sub> =-800A (diode forward voltage)	—	—	1.8	V
h <sub>FE</sub>	DC current gain	I <sub>C</sub> =800A, V <sub>CE</sub> =4.0V	750	—	—	—
t <sub>on</sub>	Switching time	V <sub>CC</sub> =600V, I <sub>C</sub> =800A, I <sub>B1</sub> =1.6A, -I <sub>B2</sub> =16A	—	—	2.5	μs
t <sub>s</sub>			—	—	20	μs
t <sub>f</sub>			—	—	5.0	μs
R <sub>th(j-c) Q</sub>	Thermal resistance (junction to case)	Transistor part	—	—	0.023	°C/W
R <sub>th(j-c) R</sub>		Diode part	—	—	0.12	°C/W
R <sub>th(c-f)</sub>	Contact thermal resistance (case to fin)	Conductive grease applied	—	—	0.01	°C/W

# QM800HA-24B

HIGH POWER SWITCHING USE  
INSULATED TYPE

## PERFORMANCE CURVES

**COMMON EMITTER OUTPUT CHARACTERISTICS (TYPICAL)**

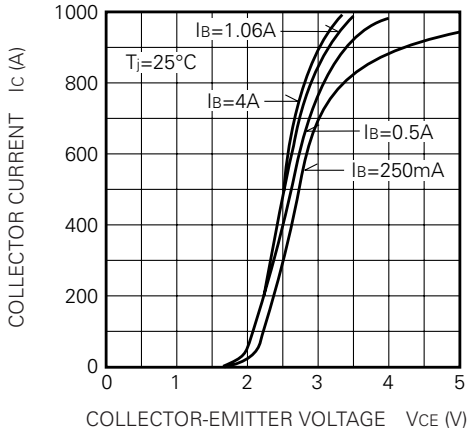

**DC CURRENT GAIN VS. COLLECTOR CURRENT (TYPICAL)**

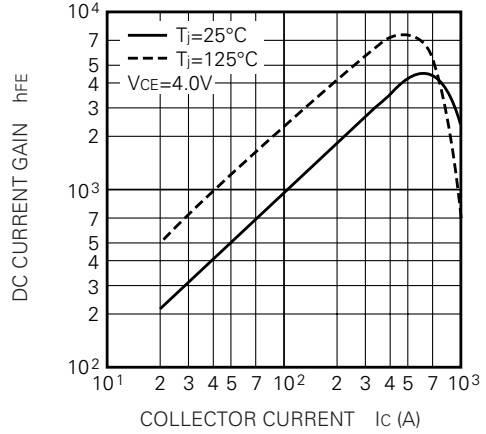

**COMMON EMITTER INPUT CHARACTERISTIC (TYPICAL)**

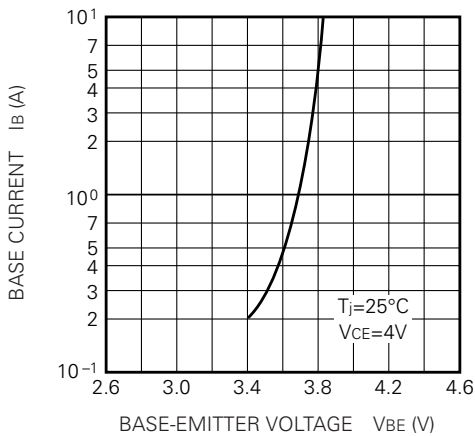

**SATURATION VOLTAGE CHARACTERISTICS (TYPICAL)**

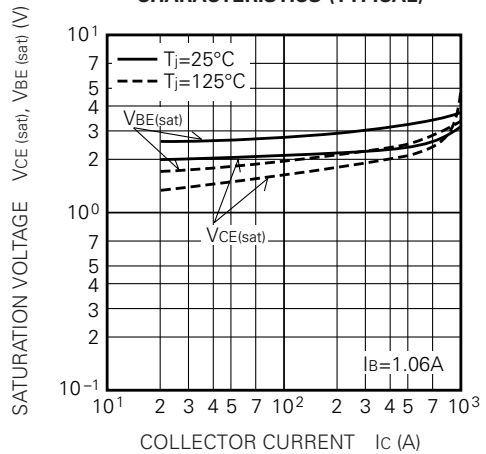

**COLLECTOR-EMITTER SATURATION VOLTAGE (TYPICAL)**

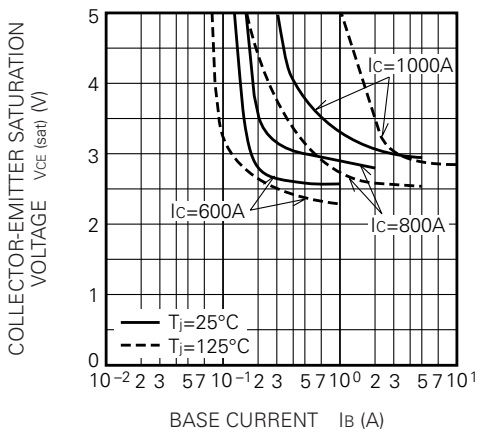

**REVERSE COLLECTOR CURRENT VS. COLLECTOR-EMITTER REVERSE VOLTAGE (DIODE FORWARD CHARACTERISTICS) (TYPICAL)**

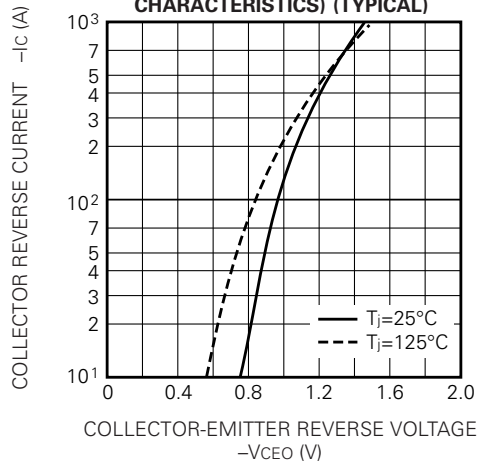

# QM800HA-24B

HIGH POWER SWITCHING USE  
INSULATED TYPE

---

## REVERSE BIAS SAFE OPERATING AREA

