

MITSUBISHI TRANSISTOR MODULES
QM50E2Y/E3Y-H

MEDIUM POWER SWITCHING USE
 INSULATED TYPE

QM50E2Y/E3Y-H



- **IC** Collector current **50A**
- **V_{CEX}** Collector-emitter voltage **600V**
- **h_{FE}** DC current gain **75**
- **Insulated Type**
- **UL Recognized**

Yellow Card No. E80276 (N)
 File No. E80271

APPLICATION

DC chopper, DC motor controllers, Inverters

OUTLINE DRAWING & CIRCUIT DIAGRAM

Dimensions in mm

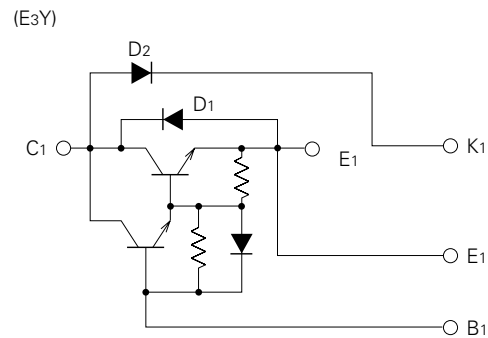
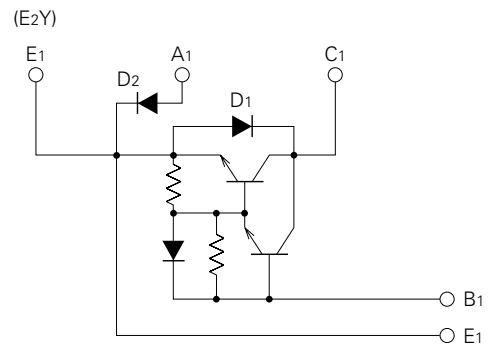
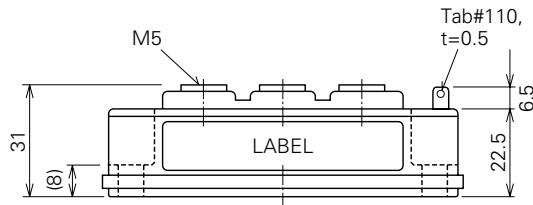
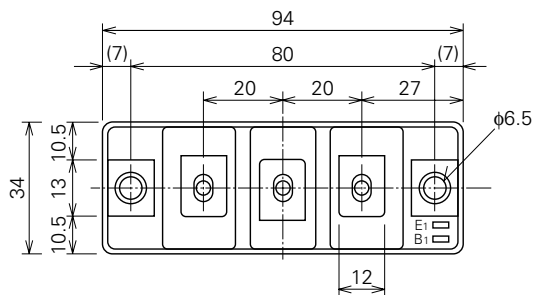

QM50E2Y/E3Y-H

**MEDIUM POWER SWITCHING USE
INSULATED TYPE**

ABSOLUTE MAXIMUM RATINGS (Transistor part including D1, $T_j=25^\circ\text{C}$)

| Symbol | Parameter | Conditions | Ratings | Unit |
|------------|---------------------------------------------------------|---------------------------------------------|---------|------|
| VCEX (SUS) | Collector-emitter voltage | $I_C=1\text{A}$, $V_{EB}=2\text{V}$ | 600 | V |
| VCEX | Collector-emitter voltage | $V_{EB}=2\text{V}$ | 600 | V |
| VCBO | Collector-base voltage | Emitter open | 600 | V |
| VEBO | Emitter-base voltage | Collector open | 7 | V |
| I_C | Collector current | DC | 50 | A |
| $-I_C$ | Collector reverse current | DC (forward diode current) | 50 | A |
| P_C | Collector dissipation | $T_C=25^\circ\text{C}$ | 310 | W |
| I_B | Base current | DC | 3 | A |
| $-I_{CSM}$ | Surge collector reverse current (forward diode current) | Peak value of one cycle of 60Hz (half wave) | 500 | A |

ABSOLUTE MAXIMUM RATINGS (Diode part (D2), $T_j=25^\circ\text{C}$)

| Symbol | Parameter | Conditions | Ratings | Unit |
|------------|----------------------------------------|---------------------------------------------|-------------------|----------------------|
| VRRM | Repetitive peak reverse voltage | | 600 | V |
| VRSM | Non-repetitive peak reverse voltage | | 720 | V |
| V_R (DC) | DC reverse voltage | | 480 | V |
| I_{DC} | DC current | DC circuit, resistive, inductive load | 50 | A |
| I_{FSM} | Surge (non-repetitive) forward current | Peak value of one cycle of 60Hz (half wave) | 1000 | A |
| I^2t | I^2t for fusing | Value for one cycle of surge current | 4.2×10^3 | A^2s |

ABSOLUTE MAXIMUM RATINGS (Common)

| Symbol | Parameter | Conditions | Ratings | Unit |
|-----------|----------------------|---------------------------------------|----------------|------------------|
| T_j | Junction temperature | | $-40 \sim 150$ | $^\circ\text{C}$ |
| T_{stg} | Storage temperature | | $-40 \sim 125$ | $^\circ\text{C}$ |
| V_{iso} | Isolation voltage | Charged part to case, AC for 1 minute | 2500 | V |
| — | Mounting torque | Main terminal screw M5 | 1.47~1.96 | N·m |
| | | | 15~20 | kg·cm |
| | | Mounting screw M6 | 1.96~2.94 | N·m |
| | | | 20~30 | kg·cm |
| — | Weight | Typical value | 210 | g |

ELECTRICAL CHARACTERISTICS (Transistor part including D1, $T_j=25^\circ\text{C}$)

| Symbol | Parameter | Test conditions | Limits | | | Unit |
|----------------|------------------------------------------|----------------------------------------------------------------------|--------|------|------|---------------------------|
| | | | Min. | Typ. | Max. | |
| I_{CEX} | Collector cutoff current | $V_{CE}=600\text{V}$, $V_{EB}=2\text{V}$ | — | — | 1.0 | mA |
| I_{CBO} | Collector cutoff current | $V_{CB}=600\text{V}$, Emitter open | — | — | 1.0 | mA |
| I_{EBO} | Emitter cutoff current | $V_{EB}=7\text{V}$ | — | — | 200 | mA |
| $V_{CE(sat)}$ | Collector-emitter saturation voltage | $I_C=50\text{A}$, $I_B=0.65\text{A}$ | — | — | 2.0 | V |
| $V_{BE(sat)}$ | Base-emitter saturation voltage | | — | — | 2.5 | V |
| $-V_{CEO}$ | Collector-emitter reverse voltage | $-I_C=50\text{A}$ (diode forward voltage) | — | — | 1.75 | V |
| h_{FE} | DC current gain | $I_C=50\text{A}$, $V_{CE}=2\text{V}/5\text{V}$ | 75/100 | — | — | — |
| t_{on} | Switching time | $V_{CC}=300\text{V}$, $I_C=50\text{A}$, $I_{B1}=-I_{B2}=1\text{A}$ | — | — | 1.5 | μs |
| t_s | | | — | — | 12 | μs |
| t_f | | | — | — | 3.0 | μs |
| $R_{th(j-c)Q}$ | Thermal resistance (junction to case) | Transistor part | — | — | 0.4 | $^\circ\text{C}/\text{W}$ |
| $R_{th(j-c)R}$ | | Diode part | — | — | 1.3 | $^\circ\text{C}/\text{W}$ |
| $R_{th(c-f)}$ | Contact thermal resistance (case to fin) | Conductive grease applied | — | — | 0.15 | $^\circ\text{C}/\text{W}$ |

QM50E2Y/E3Y-H

**MEDIUM POWER SWITCHING USE
INSULATED TYPE**

ELECTRICAL CHARACTERISTICS (Diode part (D2), $T_j=25^\circ\text{C}$)

| Symbol | Parameter | Test conditions | Limits | | | Unit |
|---------------|---------------------------------|------------------------------------------------------------------------------------------|--------|------|------|---------------------------|
| | | | Min. | Typ. | Max. | |
| I_{RRM} | Repetitive peak reverse current | $V_R=V_{RRM}, T_j=150^\circ\text{C}$ | — | — | 5.0 | mA |
| V_{FM} | Forward voltage | $I_F=50\text{A}$ | — | — | 1.5 | V |
| t_{rr} | Reverse recovery time | $I_F=50\text{A}, di/dt=-100\text{A}/\mu\text{s}, V_R=300\text{V}, T_j=150^\circ\text{C}$ | — | — | 0.9 | μs |
| Q_{rr} | Reverse recovery charge | | — | — | 20 | μC |
| $R_{th(j-c)}$ | Thermal resistance | Junction to case | — | — | 0.65 | $^\circ\text{C}/\text{W}$ |
| $R_{th(c-f)}$ | Contact thermal resistance | Conductive grease applied (case to fin) | — | — | 0.15 | $^\circ\text{C}/\text{W}$ |

PERFORMANCE CURVES

COMMON EMITTER OUTPUT CHARACTERISTICS (TYPICAL)

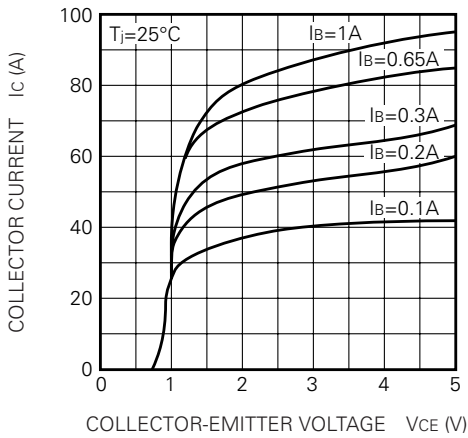

DC CURRENT GAIN VS. COLLECTOR CURRENT (TYPICAL)

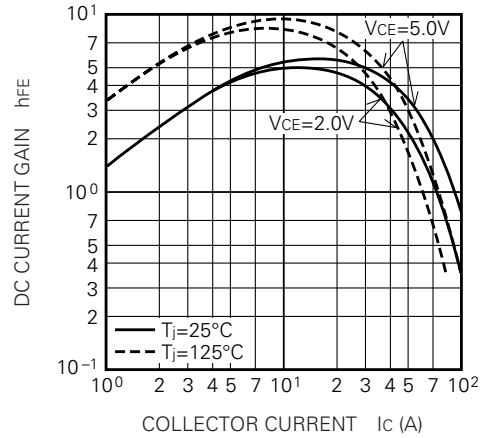

COMMON EMITTER INPUT CHARACTERISTIC (TYPICAL)

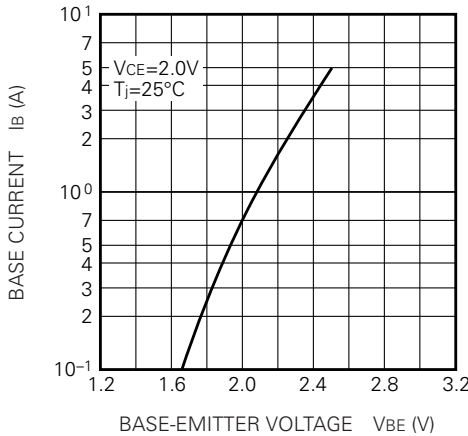

SATURATION VOLTAGE CHARACTERISTICS (TYPICAL)

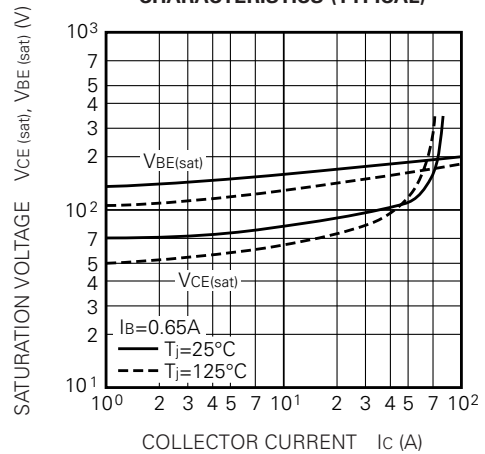

QM50E2Y/E3Y-H

HIGH POWER SWITCHING USE
INSULATED TYPE

COLLECTOR-EMITTER SATURATION VOLTAGE (TYPICAL)

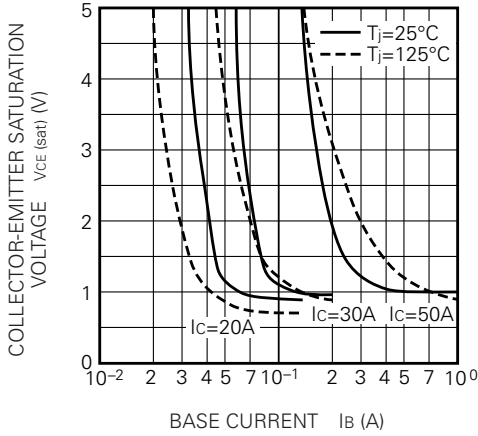

SWITCHING TIME VS. COLLECTOR CURRENT (TYPICAL)

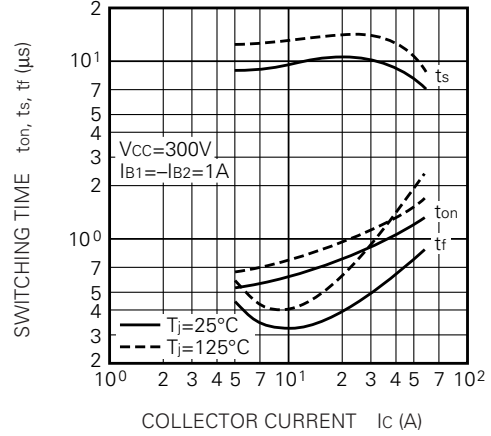

SWITCHING TIME VS. BASE CURRENT (TYPICAL)

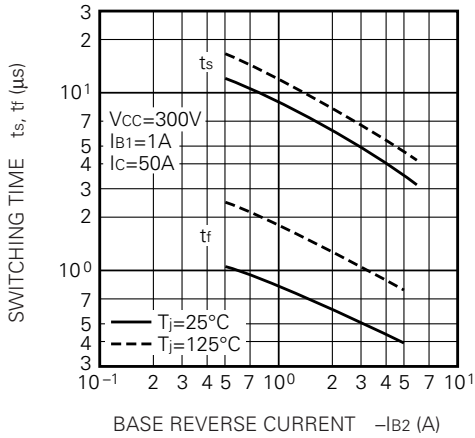

REVERSE BIAS SAFE OPERATING AREA

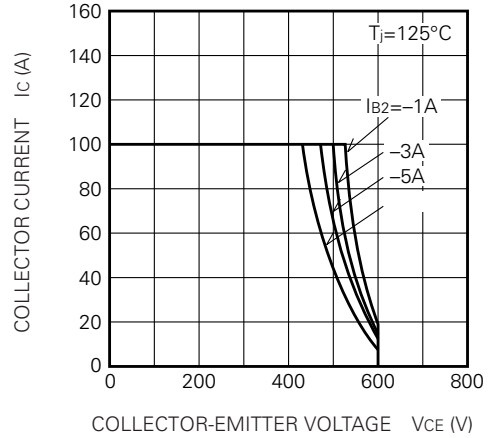

FORWARD BIAS SAFE OPERATING AREA

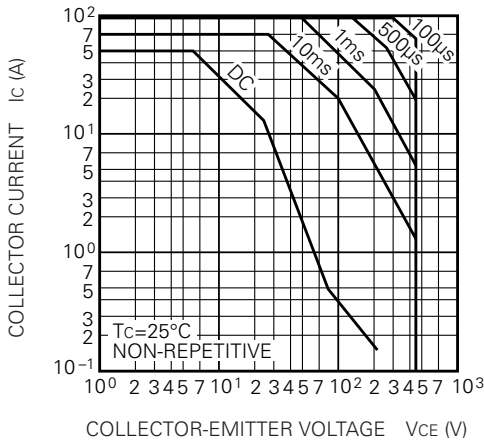

DERATING FACTOR OF F. B. S. O. A.

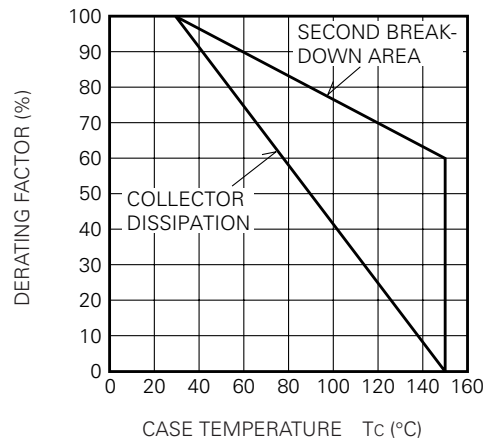

QM50E2Y/E3Y-H

MEDIUM POWER SWITCHING USE
INSULATED TYPE

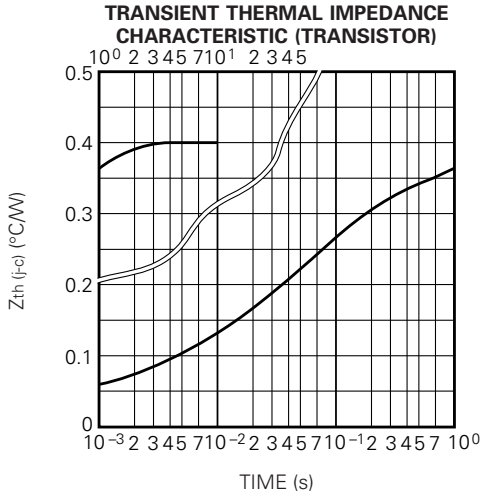

PERFORMANCE CURVES (Diode part (D1))

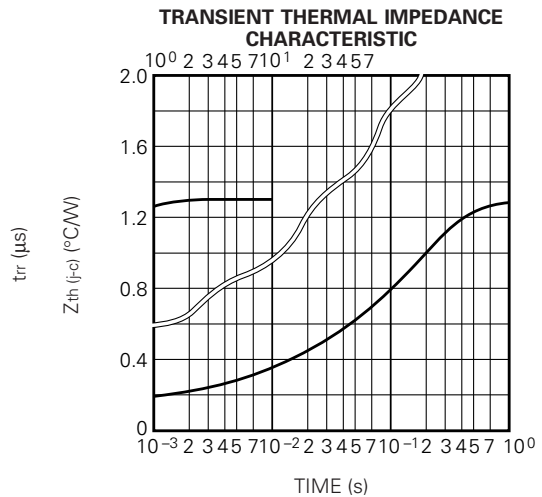
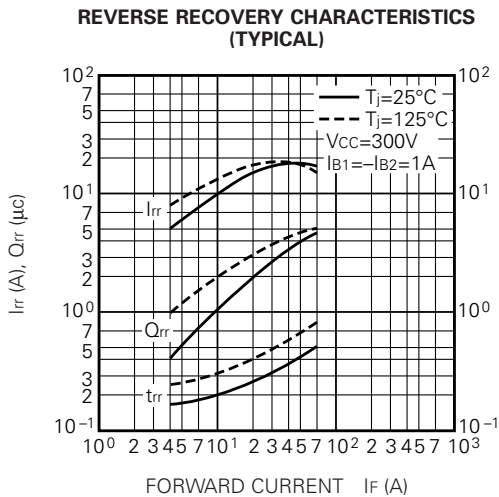
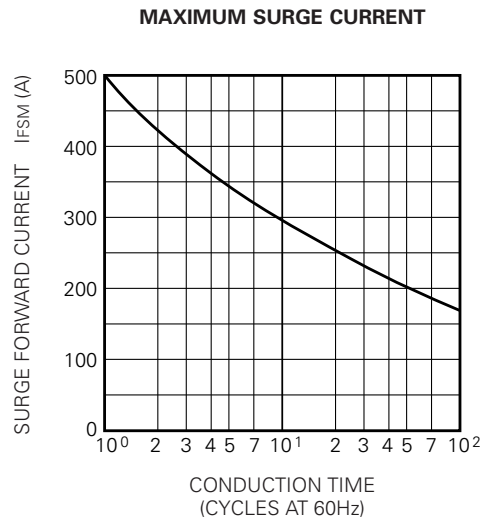
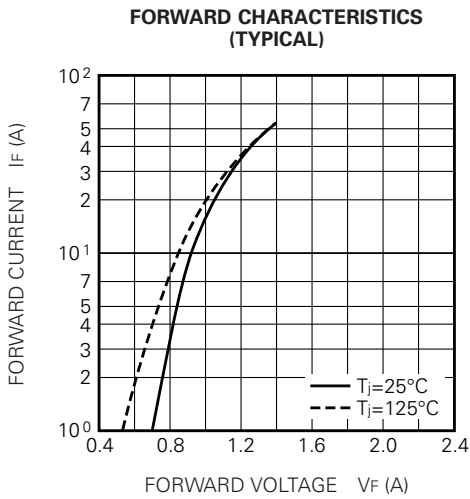

QM50E2Y/E3Y-H

MEDIUM POWER SWITCHING USE
INSULATED TYPE

PERFORMANCE CURVES (Diode part (D2))

MAXIMUM FORWARD CHARACTERISTIC

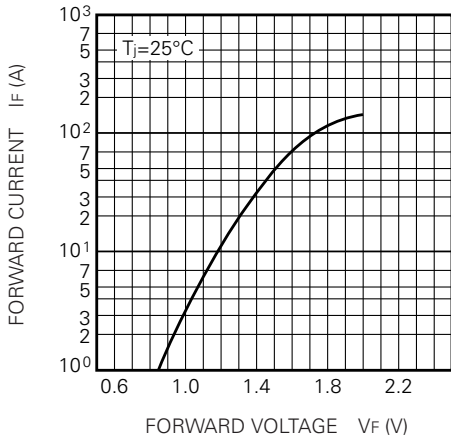

TRANSIENT THERMAL IMPEDANCE CHARACTERISTIC

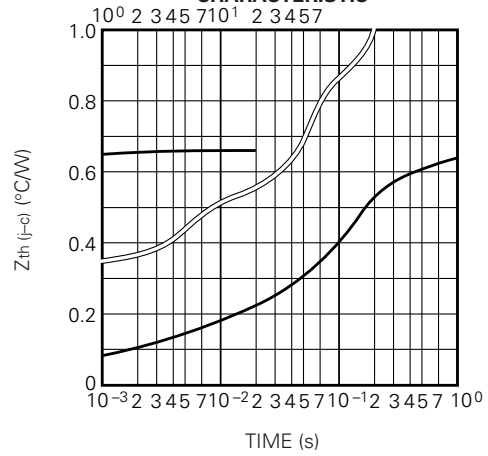

MAXIMUM SURGE CURRENT

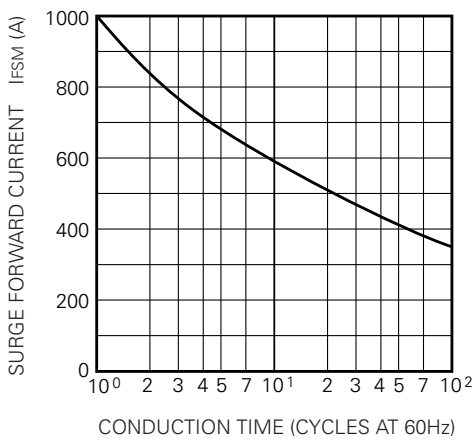

REVERSE RECOVERY CHARACTERISTICS (VS. IF) (TYPICAL)

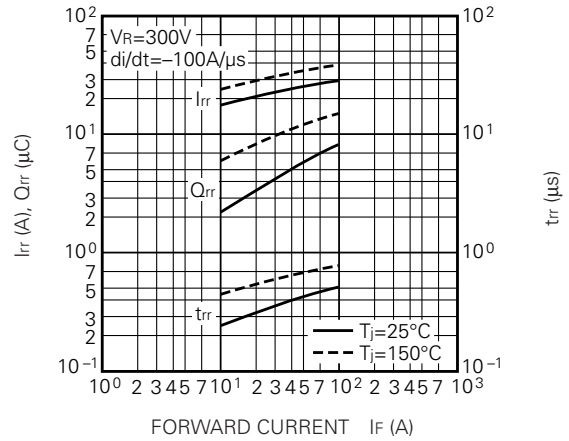

REVERSE RECOVERY CHARACTERISTICS (VS. di/dt) (TYPICAL)

