

# QM400HA-H

HIGH POWER SWITCHING USE  
INSULATED TYPE

QM400HA-H



- **IC** Collector current ..... **400A**
- **VCEX** Collector-emitter voltage ..... **600V**
- **hFE** DC current gain ..... **750**
- **Insulated Type**
- **UL Recognized**

Yellow Card No. E80276 (N)

File No. E80271

## APPLICATION

AC motor controllers, UPS, DC motor controllers, NC equipment

## OUTLINE DRAWING & CIRCUIT DIAGRAM

Dimensions in mm

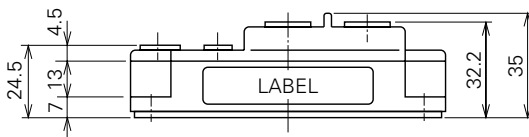
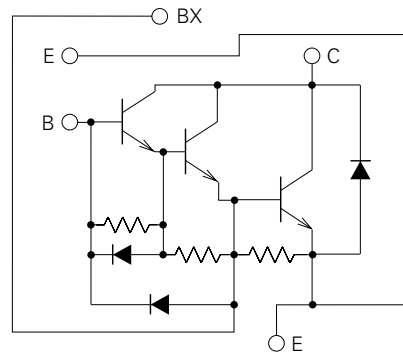
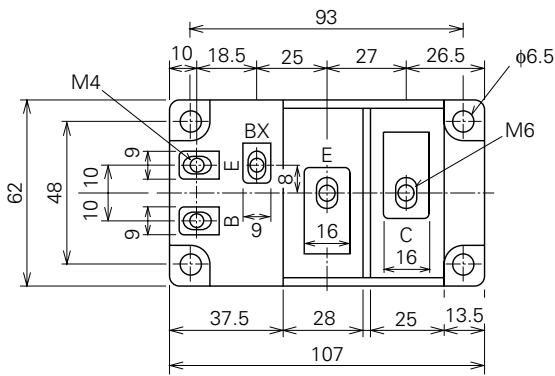

**QM400HA-H**

**HIGH POWER SWITCHING USE  
INSULATED TYPE**

**ABSOLUTE MAXIMUM RATINGS** (T<sub>j</sub>=25°C, unless otherwise noted)

Symbol	Parameter	Conditions	Ratings	Unit
V <sub>CEX (SUS)</sub>	Collector-emitter voltage	I <sub>C</sub> =1A, V <sub>EB</sub> =2V	600	V
V <sub>CEX</sub>	Collector-emitter voltage	V <sub>EB</sub> =2V	600	V
V <sub>CBO</sub>	Collector-base voltage	Emitter open	600	V
V <sub>EBO</sub>	Emitter-base voltage	Collector open	7	V
I <sub>C</sub>	Collector current	DC	400	A
-I <sub>C</sub>	Collector reverse current	DC (forward diode current)	400	A
P <sub>C</sub>	Collector dissipation	T <sub>C</sub> =25°C	1500	W
I <sub>B</sub>	Base current	DC	10	A
-I <sub>CSM</sub>	Surge collector reverse current (forward diode current)	Peak value of one cycle of 60Hz (half wave)	4000	A
T <sub>j</sub>	Junction temperature		-40~+150	°C
T <sub>stg</sub>	Storage temperature		-40~+125	°C
V <sub>iso</sub>	Isolation voltage	Charged part to case, AC for 1 minute	2500	V
—	Mounting torque	Main terminal screw M6	1.96~2.94	N·m
			20~30	kg·cm
		Mounting screw M6	1.96~2.94	N·m
			20~30	kg·cm
		B(E) terminal screw M4	0.98~1.47	N·m
		10~15	kg·cm	
		BX terminal screw M4	0.98~1.47	N·m
			10~15	kg·cm
—	Weight	Typical value	640	g

**ELECTRICAL CHARACTERISTICS** (T<sub>j</sub>=25°C, unless otherwise noted)

Symbol	Parameter	Test conditions	Limits			Unit
			Min.	Typ.	Max.	
I <sub>CEX</sub>	Collector cutoff current	V <sub>CE</sub> =600V, V <sub>EB</sub> =2V	—	—	5.0	mA
I <sub>CBO</sub>	Collector cutoff current	V <sub>CB</sub> =600V, Emitter open	—	—	5.0	mA
I <sub>EBO</sub>	Emitter cutoff current	V <sub>EB</sub> =7V	—	—	400	mA
V <sub>CE (sat)</sub>	Collector-emitter saturation voltage	I <sub>C</sub> =400A, I <sub>B</sub> =0.53A	—	—	2.5	V
V <sub>BE (sat)</sub>	Base-emitter saturation voltage		—	—	3.5	V
-V <sub>CEO</sub>	Collector-emitter reverse voltage	-I <sub>C</sub> =400A (diode forward voltage)	—	—	1.8	V
h <sub>FE</sub>	DC current gain	I <sub>C</sub> =400A, V <sub>CE</sub> =2.5V	750	—	—	—
t <sub>on</sub>	Switching time	V <sub>CC</sub> =300V, I <sub>C</sub> =400A, I <sub>B1</sub> =0.8A, -I <sub>B2</sub> =8A	—	—	3.0	μs
t <sub>s</sub>			—	—	10	μs
t <sub>f</sub>			—	—	35	μs
R <sub>th (j-c) Q</sub>			Thermal resistance (junction to case)	Transistor part	—	—
R <sub>th (j-c) R</sub>	Diode part	—		—	0.25	°C/W
R <sub>th (c-f)</sub>	Contact thermal resistance (case to fin)	Conductive grease applied	—	—	0.04	°C/W

# QM400HA-H

HIGH POWER SWITCHING USE  
INSULATED TYPE

## PERFORMANCE CURVES

**COMMON EMITTER OUTPUT CHARACTERISTICS (TYPICAL)**

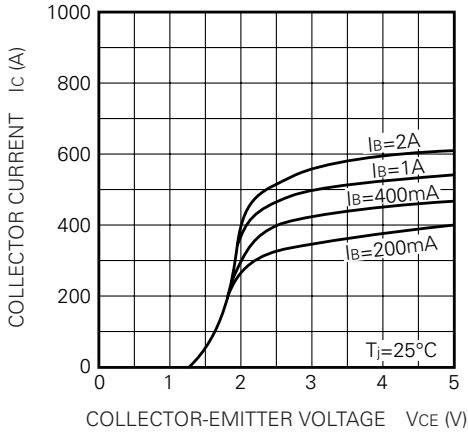

**DC CURRENT GAIN VS. COLLECTOR CURRENT (TYPICAL)**

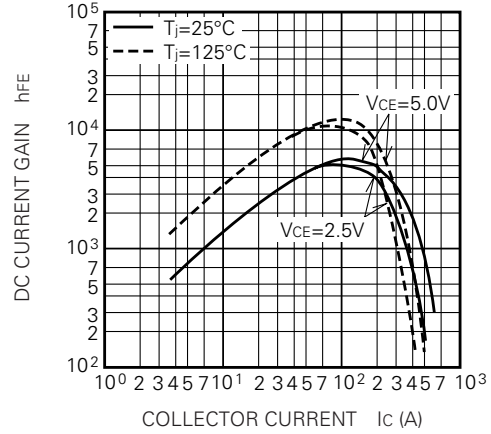

**COMMON EMITTER INPUT CHARACTERISTIC (TYPICAL)**

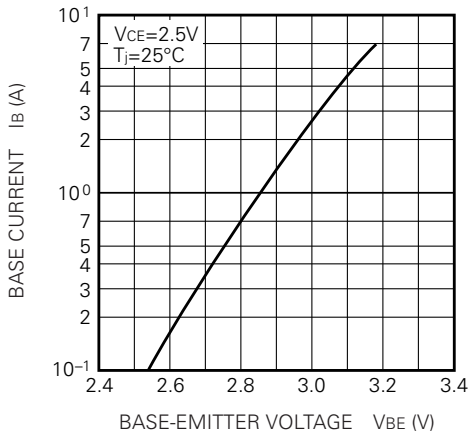

**SATURATION VOLTAGE CHARACTERISTICS (TYPICAL)**

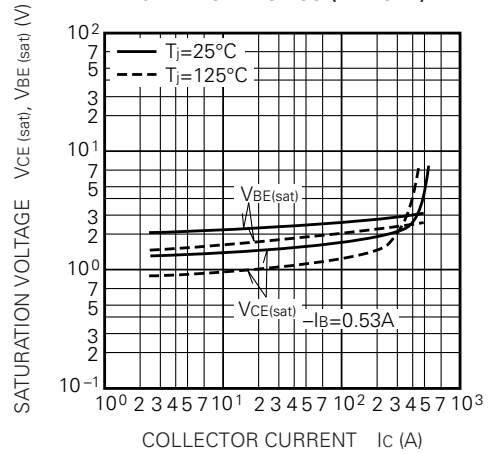

**COLLECTOR-EMITTER SATURATION VOLTAGE (TYPICAL)**

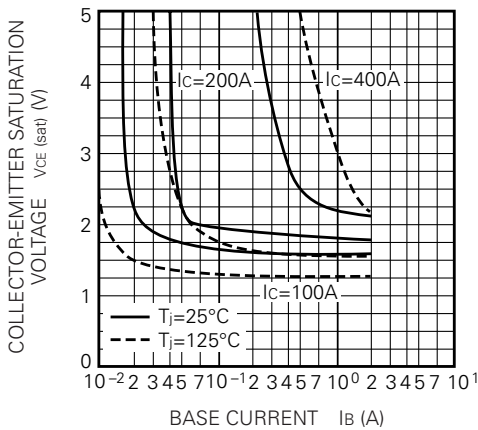

**SWITCHING TIME VS. COLLECTOR CURRENT (TYPICAL)**

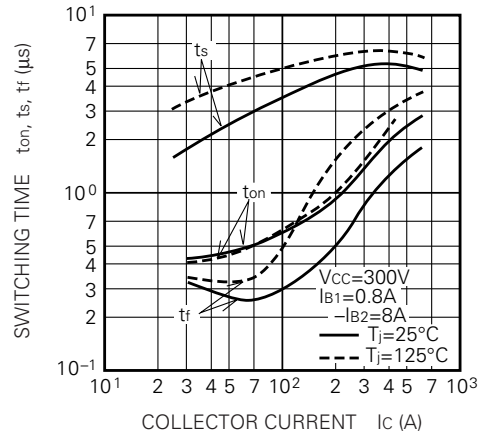

**QM400HA-H**

**HIGH POWER SWITCHING USE  
INSULATED TYPE**

**SWITCHING TIME VS. BASE CURRENT (TYPICAL)**

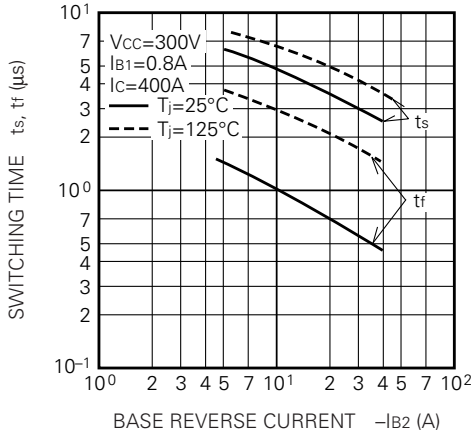

**REVERSE BIAS SAFE OPERATING AREA**

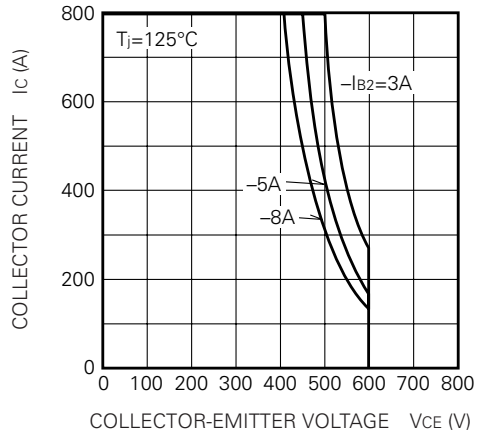

**FORWARD BIAS SAFE OPERATING AREA**

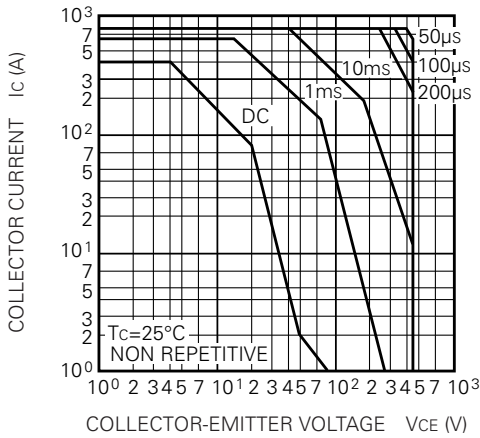

**DERATING FACTOR OF F. B. S. O. A.**

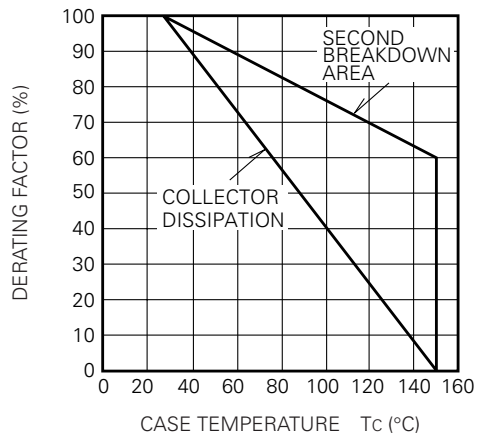

**TRANSIENT THERMAL IMPEDANCE CHARACTERISTIC (TRANSISTOR)**

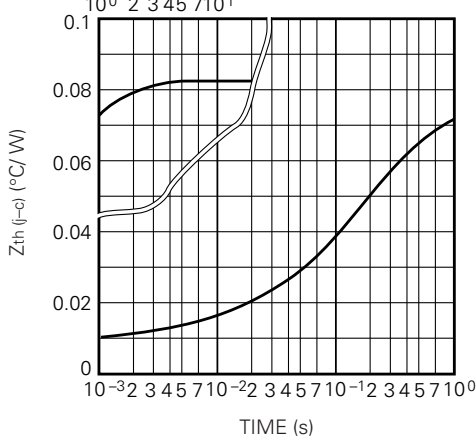

**REVERSE COLLECTOR CURRENT VS. COLLECTOR-EMITTER REVERSE VOLTAGE (DIODE FORWARD CHARACTERISTICS) (TYPICAL)**

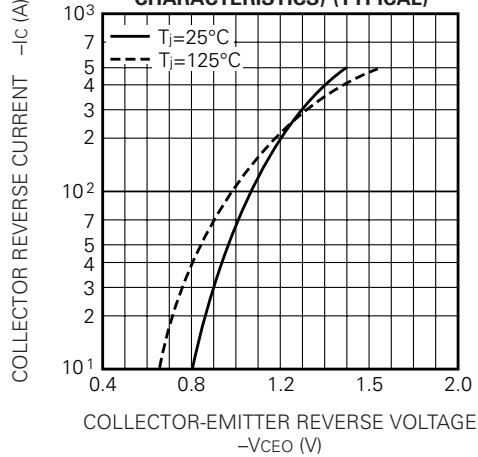

# QM400HA-H

HIGH POWER SWITCHING USE  
INSULATED TYPE

**RATED SURGE COLLECTOR REVERSE CURRENT  
(DIODE FORWARD SURGE CURRENT)**

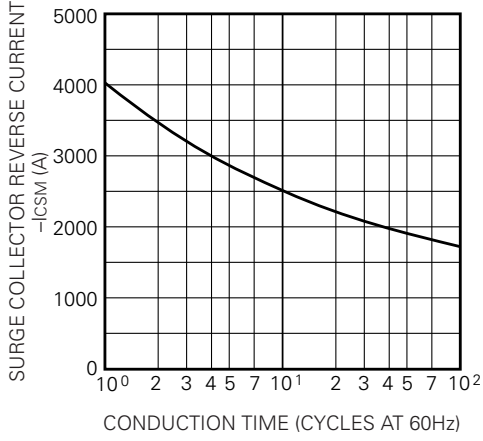

**TRANSIENT THERMAL IMPEDANCE  
CHARACTERISTIC (DIODE)**

