

MITSUBISHI TRANSISTOR MODULES  
**QM30E2Y/E3Y-H**

MEDIUM POWER SWITCHING USE  
 INSULATED TYPE

QM30E2Y/E3Y-H



- **IC** Collector current ..... **30A**
- **VCEX** Collector-emitter voltage ..... **600V**
- **hFE** DC current gain ..... **75**
- **Insulated Type**
- **UL Recognized**

Yellow Card No. E80276 (N)  
 File No. E80271

**APPLICATION**

DC chopper, DC motor controllers, Inverters

**OUTLINE DRAWING & CIRCUIT DIAGRAM**

Dimensions in mm

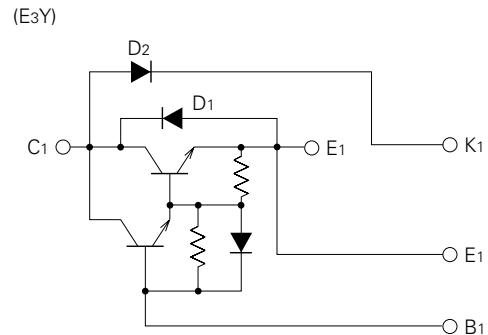
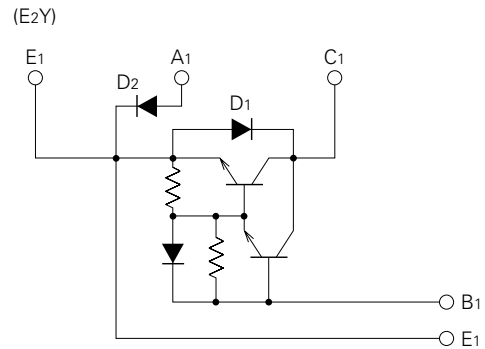
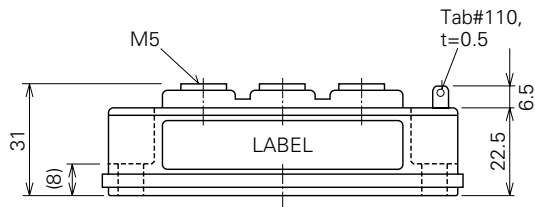
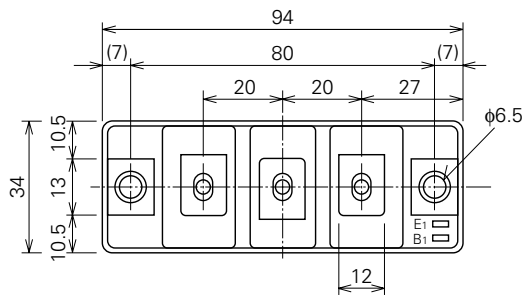

**QM30E2Y/E3Y-H**

**MEDIUM POWER SWITCHING USE  
INSULATED TYPE**

**ABSOLUTE MAXIMUM RATINGS** (Transistor part including D1,  $T_j=25^\circ\text{C}$ )

Symbol	Parameter	Conditions	Ratings	Unit
VCEX (SUS)	Collector-emitter voltage	$I_C=1\text{A}$ , $V_{EB}=2\text{V}$	600	V
VCEX	Collector-emitter voltage	$V_{EB}=2\text{V}$	600	V
VCBO	Collector-base voltage	Emitter open	600	V
VEBO	Emitter-base voltage	Collector open	7	V
$I_C$	Collector current	DC	30	A
$-I_C$	Collector reverse current	DC (forward diode current)	30	A
PC	Collector dissipation	$T_c=25^\circ\text{C}$	250	W
$I_B$	Base current	DC	1.8	A
$-I_{CSM}$	Surge collector reverse current (forward diode current)	Peak value of one cycle of 60Hz (half wave)	300	A

**ABSOLUTE MAXIMUM RATINGS** (Diode part (D2),  $T_j=25^\circ\text{C}$ )

Symbol	Parameter	Conditions	Ratings	Unit
VRRM	Repetitive peak reverse voltage		600	V
VRSM	Non-repetitive peak reverse voltage		720	V
VR (DC)	DC reverse voltage		480	V
$I_{DC}$	DC current	DC circuit, resistive, inductive load	30	A
$I_{FSM}$	Surge (non-repetitive) forward current	Peak value of one cycle of 60Hz (half wave)	600	A
$I^2t$	$I^2t$ for fusing	Value for one cycle of surge current	$1.5 \times 10^3$	$\text{A}^2\text{s}$

**ABSOLUTE MAXIMUM RATINGS** (Common)

Symbol	Parameter	Conditions	Ratings	Unit
$T_j$	Junction temperature		$-40 \sim 150$	$^\circ\text{C}$
$T_{stg}$	Storage temperature		$-40 \sim 125$	$^\circ\text{C}$
$V_{iso}$	Isolation voltage	Charged part to case, AC for 1 minute	2500	V
—	Mounting torque	Main terminal screw M5	1.47~1.96	N·m
			15~20	kg·cm
		Mounting screw M6	1.96~2.94	N·m
			20~30	kg·cm
—	Weight	Typical value	210	g

**ELECTRICAL CHARACTERISTICS** (Transistor part including D1,  $T_j=25^\circ\text{C}$ )

Symbol	Parameter	Test conditions	Limits			Unit
			Min.	Typ.	Max.	
$I_{CEX}$	Collector cutoff current	$V_{CE}=600\text{V}$ , $V_{EB}=2\text{V}$	—	—	1.0	mA
$I_{CBO}$	Collector cutoff current	$V_{CB}=600\text{V}$ , Emitter open	—	—	1.0	mA
$I_{EBO}$	Emitter cutoff current	$V_{EB}=7\text{V}$	—	—	200	mA
$V_{CE(sat)}$	Collector-emitter saturation voltage	$I_C=30\text{A}$ , $I_B=0.4\text{A}$	—	—	2.0	V
$V_{BE(sat)}$	Base-emitter saturation voltage		—	—	2.5	V
$-V_{CEO}$	Collector-emitter reverse voltage	$-I_C=30\text{A}$ (diode forward voltage)	—	—	1.85	V
hFE	DC current gain	$I_C=30\text{A}$ , $V_{CE}=2\text{V}/5\text{V}$	75/100	—	—	—
$t_{on}$	Switching time	$V_{CC}=300\text{V}$ , $I_C=30\text{A}$ , $I_{B1}=-I_{B2}=0.6\text{A}$	—	—	1.5	$\mu\text{s}$
$t_s$			—	—	12	$\mu\text{s}$
$t_f$			—	—	3.0	$\mu\text{s}$
$R_{th(j-c)Q}$	Thermal resistance (junction to case)	Transistor part	—	—	0.5	$^\circ\text{C}/\text{W}$
$R_{th(j-c)R}$		Diode part	—	—	2.0	$^\circ\text{C}/\text{W}$
$R_{th(c-f)}$	Contact thermal resistance (case to fin)	Conductive grease applied	—	—	0.15	$^\circ\text{C}/\text{W}$

# QM30E2Y/E3Y-H

MEDIUM POWER SWITCHING USE  
INSULATED TYPE

## ELECTRICAL CHARACTERISTICS (Diode part (D2), $T_j=25^\circ\text{C}$ )

Symbol	Parameter	Test conditions	Limits			Unit
			Min.	Typ.	Max.	
$I_{RRM}$	Repetitive peak reverse current	$V_R=V_{RRM}, T_j=150^\circ\text{C}$	—	—	5.0	mA
$V_{FM}$	Forward voltage	$I_F=30\text{A}$	—	—	1.5	V
$t_{rr}$	Reverse recovery time	$I_F=30\text{A}, di/dt=-60\text{A}/\mu\text{s}, V_R=600\text{V}, T_j=150^\circ\text{C}$	—	—	0.9	$\mu\text{s}$
$Q_{rr}$	Reverse recovery charge		—	—	15	$\mu\text{C}$
$R_{th(j-c)}$	Thermal resistance	Junction to case	—	—	1.3	$^\circ\text{C}/\text{W}$
$R_{th(c-f)}$	Contact thermal resistance	Conductive grease applied (case to fin)	—	—	0.15	$^\circ\text{C}/\text{W}$

## PERFORMANCE CURVES

**COMMON EMITTER OUTPUT CHARACTERISTICS (TYPICAL)**

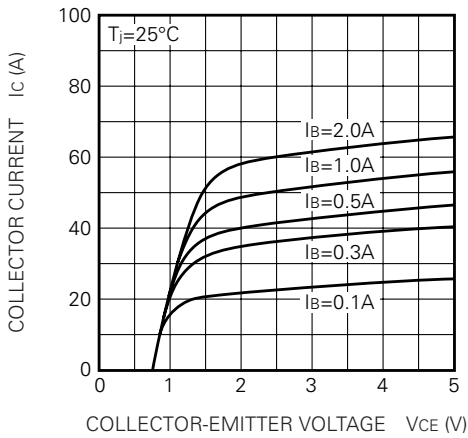

**DC CURRENT GAIN VS. COLLECTOR CURRENT (TYPICAL)**

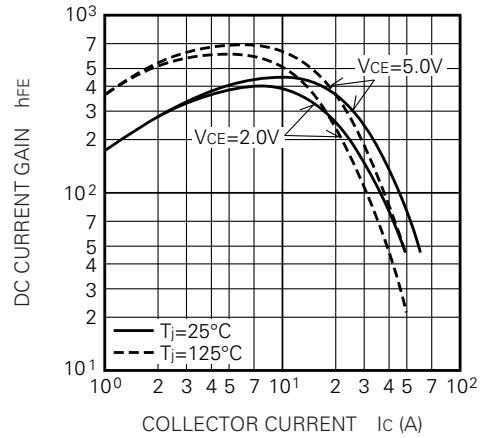

**COMMON EMITTER INPUT CHARACTERISTIC (TYPICAL)**

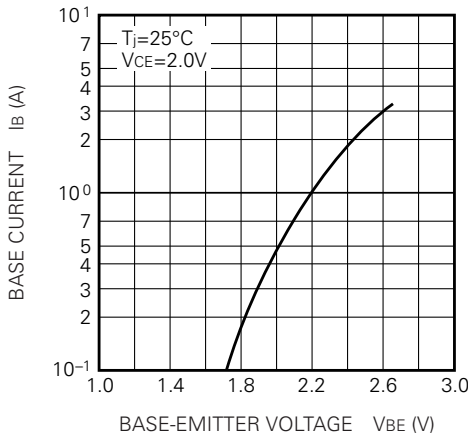

**SATURATION VOLTAGE CHARACTERISTICS (TYPICAL)**

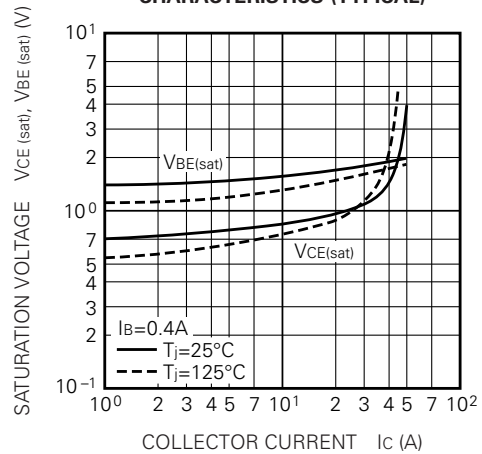

**QM30E2Y/E3Y-H**

MEDIUM POWER SWITCHING USE  
INSULATED TYPE

**COLLECTOR-EMITTER SATURATION VOLTAGE (TYPICAL)**

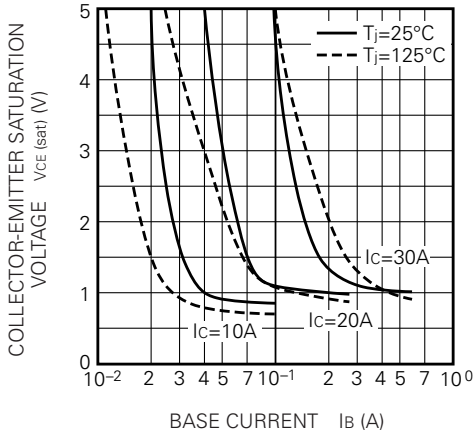

**SWITCHING TIME VS. COLLECTOR CURRENT (TYPICAL)**

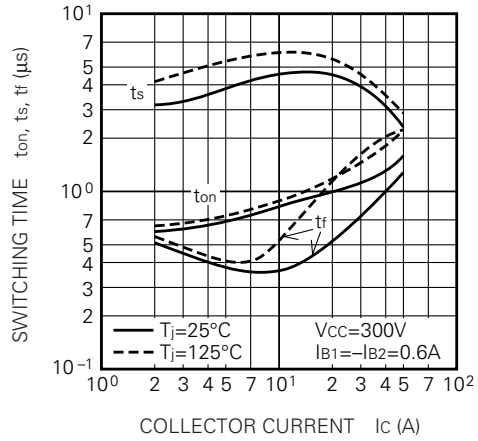

**SWITCHING TIME VS. BASE CURRENT (TYPICAL)**

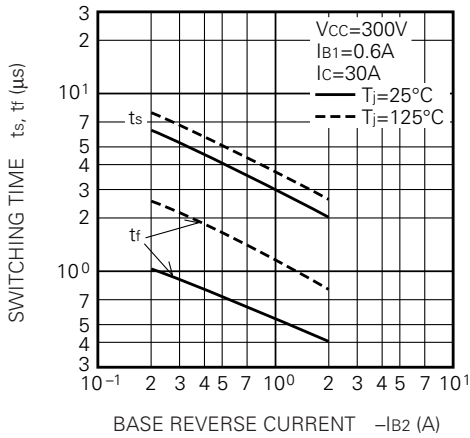

**REVERSE BIAS SAFE OPERATING AREA**

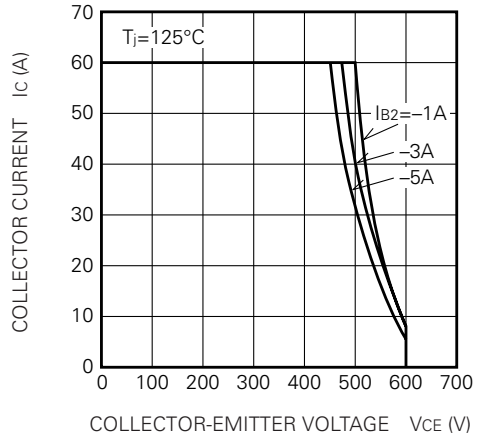

**FORWARD BIAS SAFE OPERATING AREA**

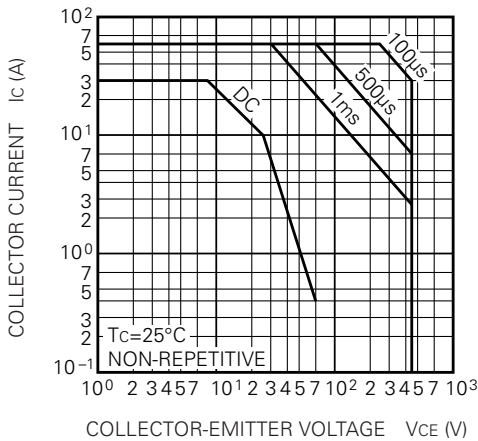

**DERATING FACTOR OF F. B. S. O. A.**

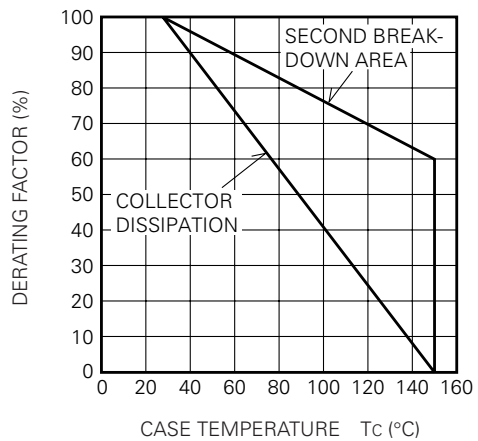

# QM30E2Y/E3Y-H

MEDIUM POWER SWITCHING USE  
INSULATED TYPE

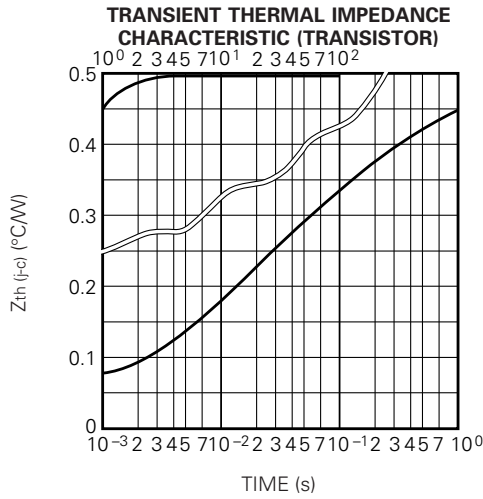

## PERFORMANCE CURVES (Diode part (D1))

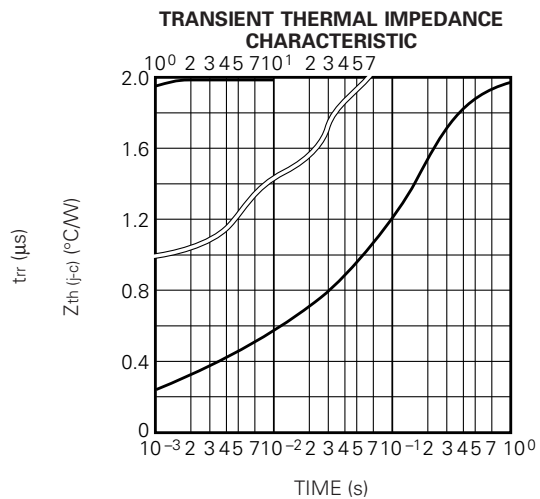
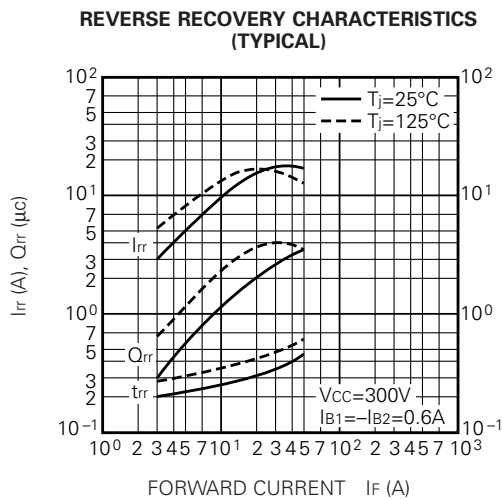
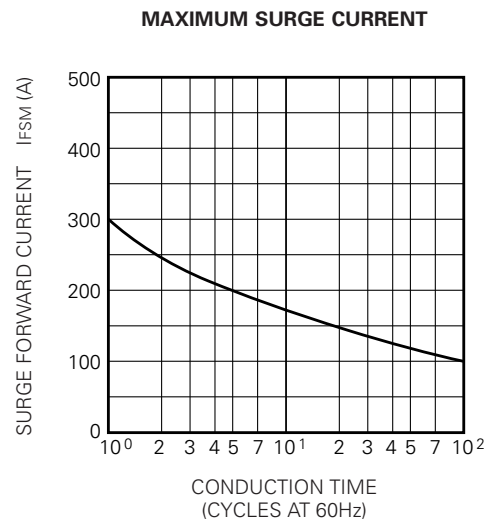
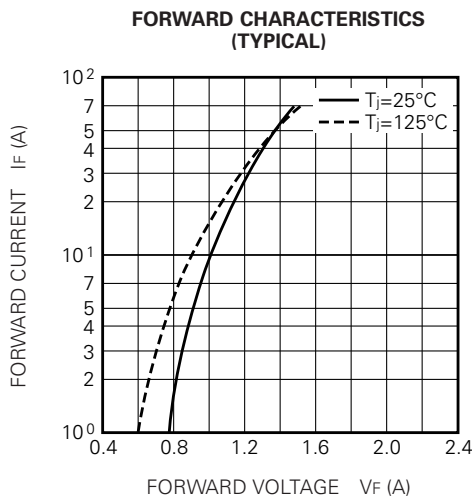

# QM30E2Y/E3Y-H

MEDIUM POWER SWITCHING USE  
INSULATED TYPE

## PERFORMANCE CURVES (Diode part (D2))

MAXIMUM FORWARD CHARACTERISTIC

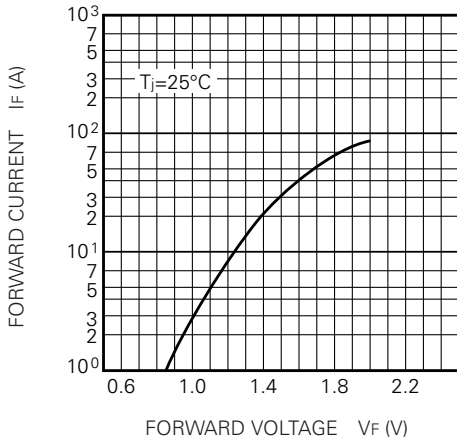

TRANSIENT THERMAL IMPEDANCE CHARACTERISTIC

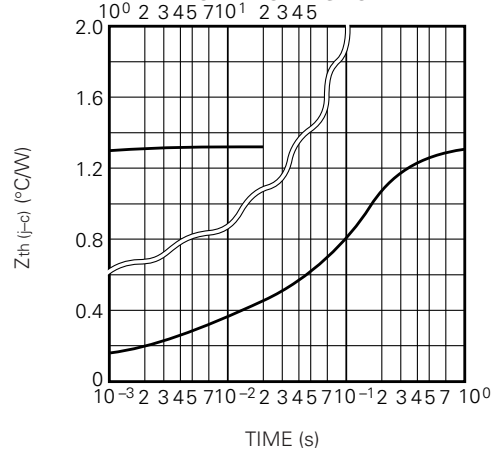

MAXIMUM SURGE CURRENT

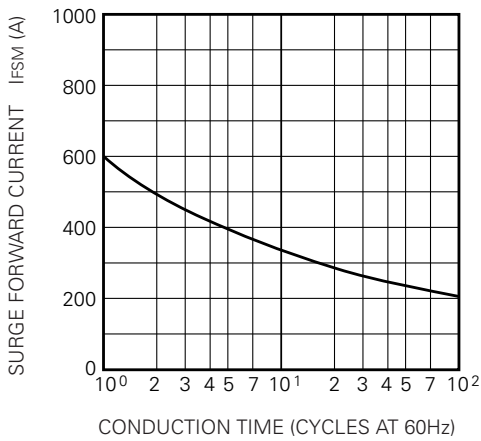

REVERSE RECOVERY CHARACTERISTICS (VS. IF) (TYPICAL)

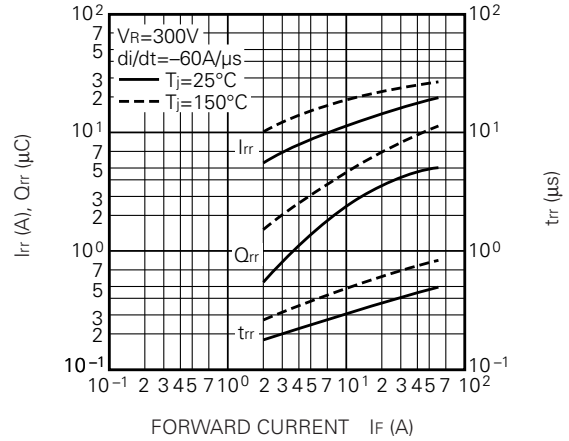

REVERSE RECOVERY CHARACTERISTICS (VS. di/dt) (TYPICAL)

