

# QM30CY-H

MEDIUM POWER SWITCHING USE  
INSULATED TYPE

## QM30CY-H



- **IC** Collector current ..... **30A**
- **VCEX** Collector-emitter voltage ..... **600V**
- **hFE** DC current gain ..... **75**
- **Insulated Type**
- **UL Recognized**

Yellow Card No. E80276 (N)  
File No. E80271

## APPLICATION

UPS, CVCF

## OUTLINE DRAWING & CIRCUIT DIAGRAM

Dimensions in mm

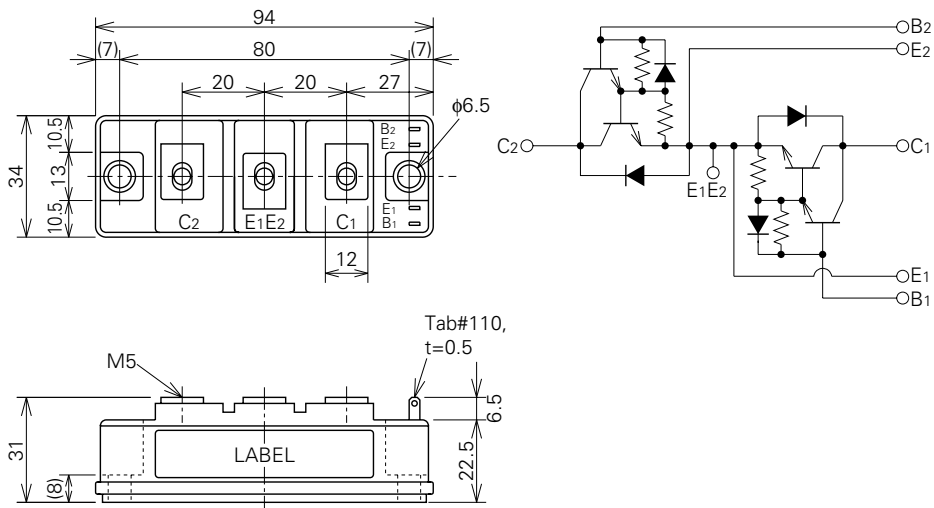

**QM30CY-H**

**MEDIUM POWER SWITCHING USE  
INSULATED TYPE**

**ABSOLUTE MAXIMUM RATINGS** (Tj=25°C, unless otherwise noted)

| Symbol     | Parameter   | Conditions                                  | Ratings   | Unit  |
|------------|---|---|-----------|-------|
| VCEX (SUS) | Collector-emitter voltage                               | IC=1A, VEB=2V                               | 600       | V     |
| VCEX       | Collector-emitter voltage                               | VEB=2V                                      | 600       | V     |
| VCBO       | Collector-base voltage                                  | Emitter open                                | 600       | V     |
| VEBO       | Emitter-base voltage                                    | Collector open                              | 7         | V     |
| IC         | Collector current                                       | DC  | 30        | A     |
| -IC        | Collector reverse current                               | DC (forward diode current)                  | 30        | A     |
| PC         | Collector dissipation                                   | Tc=25°C                                     | 250       | W     |
| IB         | Base current  | DC  | 1.8       | A     |
| -ICSM      | Surge collector reverse current (forward diode current) | Peak value of one cycle of 60Hz (half wave) | 300       | A     |
| Tj         | Junction temperature                                    |   | -40~+150  | °C    |
| Tstg       | Storage temperature                                     |   | -40~+125  | °C    |
| Viso       | Isolation voltage                                       | Charged part to case, AC for 1 minute       | 2500      | V     |
| —          | Mounting torque   | Main terminal screw M5                      | 1.47~1.96 | N·m   |
|            |   |   | 15~20     | kg·cm |
|            |   | Mounting screw M6                           | 1.96~2.94 | N·m   |
|            |   |   | 20~30     | kg·cm |
| —          | Weight  | Typical value                               | 210       | g     |

**ELECTRICAL CHARACTERISTICS** (Tj=25°C, unless otherwise noted)

| Symbol      | Parameter                                | Test conditions                            | Limits |      |      | Unit |
|-------------|--|--|--------|------|------|------|
|             |  |  | Min.   | Typ. | Max. |      |
| ICEX        | Collector cutoff current                 | VCE=600V, VEB=2V                           | —      | —    | 1.0  | mA   |
| ICBO        | Collector cutoff current                 | VCB=600V, Emitter open                     | —      | —    | 1.0  | mA   |
| IEBO        | Emitter cutoff current                   | VEB=7V                                     | —      | —    | 200  | mA   |
| VCE (sat)   | Collector-emitter saturation voltage     | IC=30A, IB=0.4A                            | —      | —    | 2.0  | V    |
| VBE (sat)   | Base-emitter saturation voltage          |  | —      | —    | 2.5  | V    |
| -VCEO       | Collector-emitter reverse voltage        | -IC=30A (diode forward voltage)            | —      | —    | 1.85 | V    |
| hFE         | DC current gain                          | IC=30A, VCE=2V/5V                          | 75/100 | —    | —    | —    |
| ton         | Switching time                           | VCC=300V, IC=30A, IB1=-IB2=0.6A            | —      | —    | 1.5  | µs   |
| ts          |  |  | —      | —    | 12   | µs   |
| tf          |  |  | —      | —    | 3.0  | µs   |
| Rth (j-c) Q | Thermal resistance (junction to case)    | Transistor part (per 1/2 module)           | —      | —    | 0.5  | °C/W |
| Rth (j-c) R |  | Diode part (per 1/2 module)                | —      | —    | 2.0  | °C/W |
| Rth (c-f)   | Contact thermal resistance (case to fin) | Conductive grease applied (per 1/2 module) | —      | —    | 0.15 | °C/W |

**QM30CY-H**

MEDIUM POWER SWITCHING USE  
INSULATED TYPE

**PERFORMANCE CURVES**

**COMMON EMITTER OUTPUT CHARACTERISTICS (TYPICAL)**

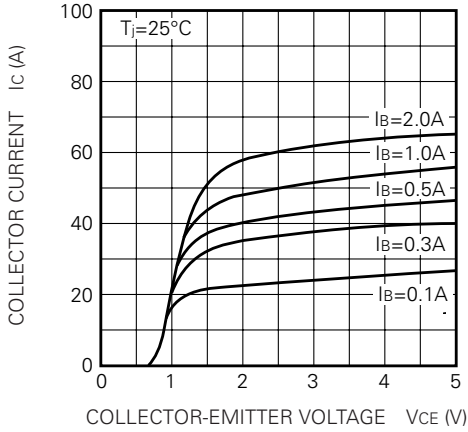

**DC CURRENT GAIN VS. COLLECTOR CURRENT (TYPICAL)**

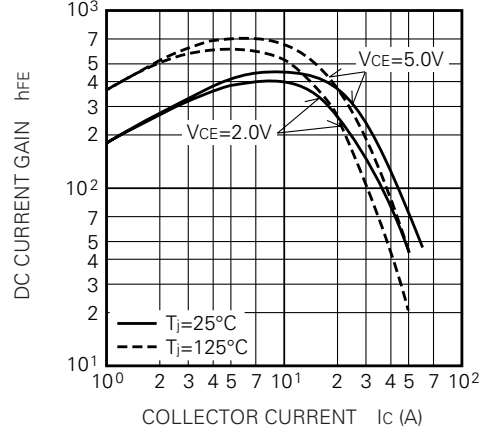

**COMMON EMITTER INPUT CHARACTERISTIC (TYPICAL)**

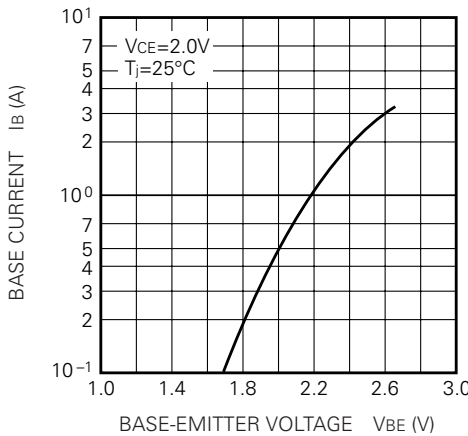

**SATURATION VOLTAGE CHARACTERISTICS (TYPICAL)**

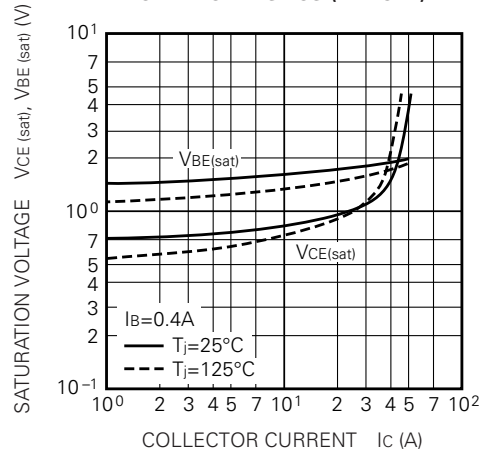

**COLLECTOR-EMITTER SATURATION VOLTAGE (TYPICAL)**

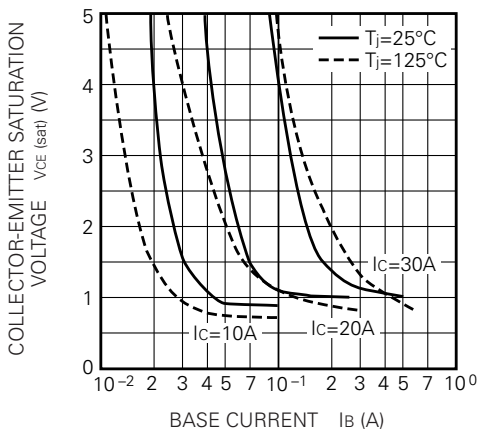

**SWITCHING TIME VS. COLLECTOR CURRENT (TYPICAL)**

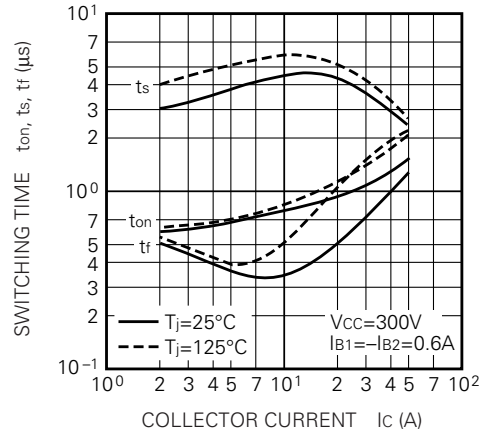

QM30CY-H

MEDIUM POWER SWITCHING USE  
INSULATED TYPE

SWITCHING TIME VS. BASE CURRENT (TYPICAL)

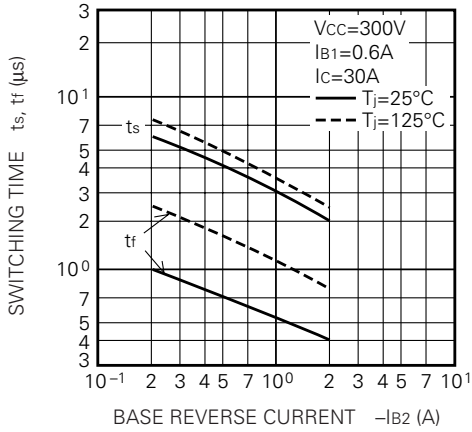

REVERSE BIAS SAFE OPERATING AREA

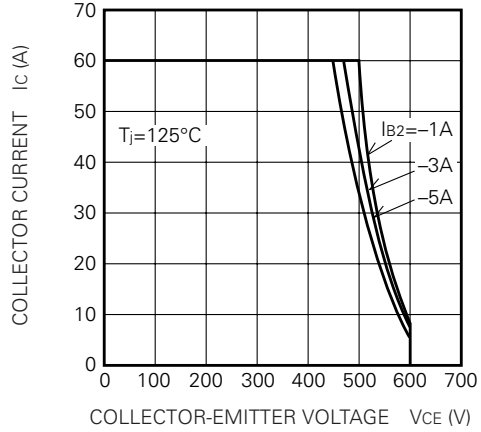

FORWARD BIAS SAFE OPERATING AREA

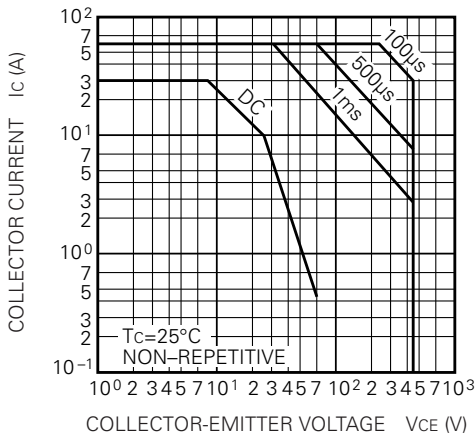

DERATING FACTOR OF F. B. S. O. A.

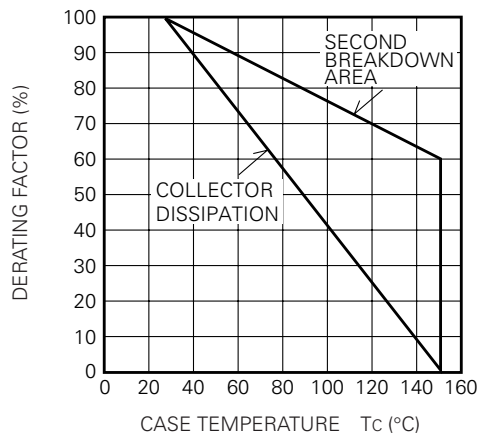

TRANSIENT THERMAL IMPEDANCE CHARACTERISTIC (TRANSISTOR)

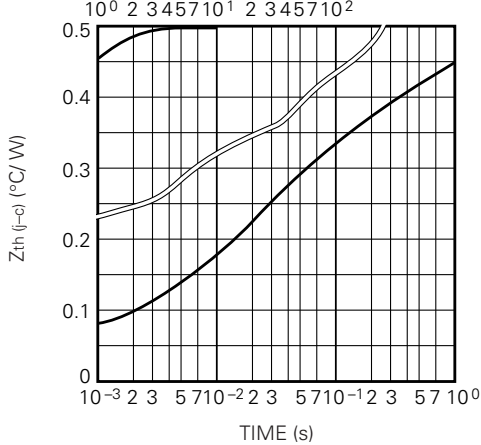

REVERSE COLLECTOR CURRENT VS. COLLECTOR-EMITTER REVERSE VOLTAGE (DIODE FORWARD CHARACTERISTICS) (TYPICAL)

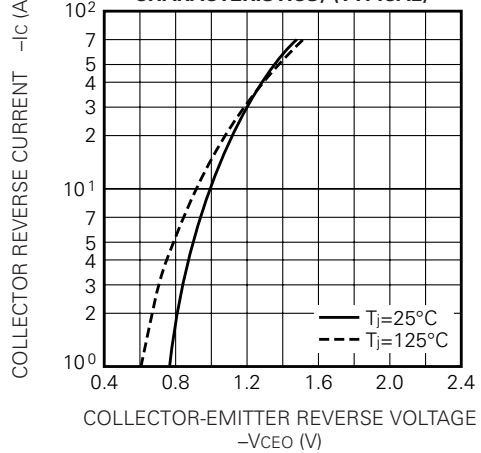

**QM30CY-H**

MEDIUM POWER SWITCHING USE  
INSULATED TYPE

**RATED SURGE COLLECTOR REVERSE CURRENT  
(DIODE FORWARD SURGE CURRENT)**

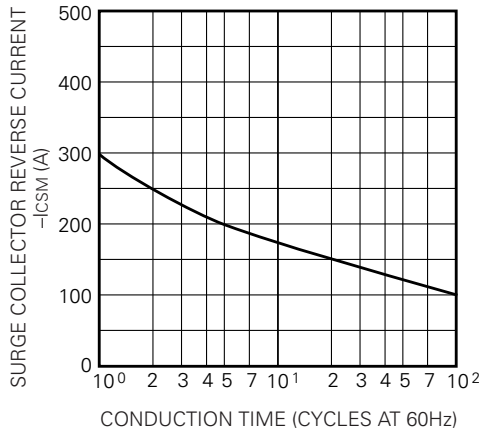

**REVERSE RECOVERY CHARACTERISTICS  
OF FREE-WHEEL DIODE (TYPICAL)**

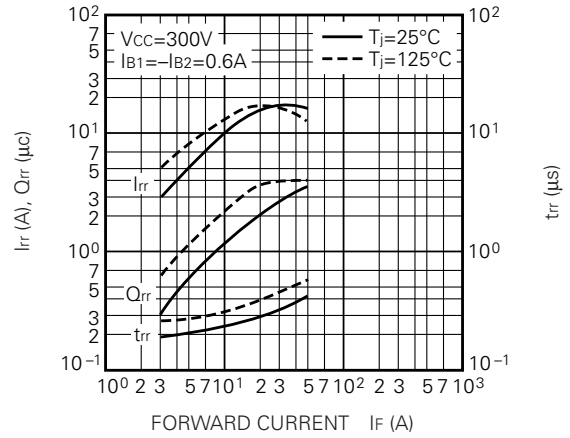

**TRANSIENT THERMAL IMPEDANCE  
CHARACTERISTIC (DIODE)**

