

Silicon Carbide MOSFET Module 100 Amperes/1200 Volts

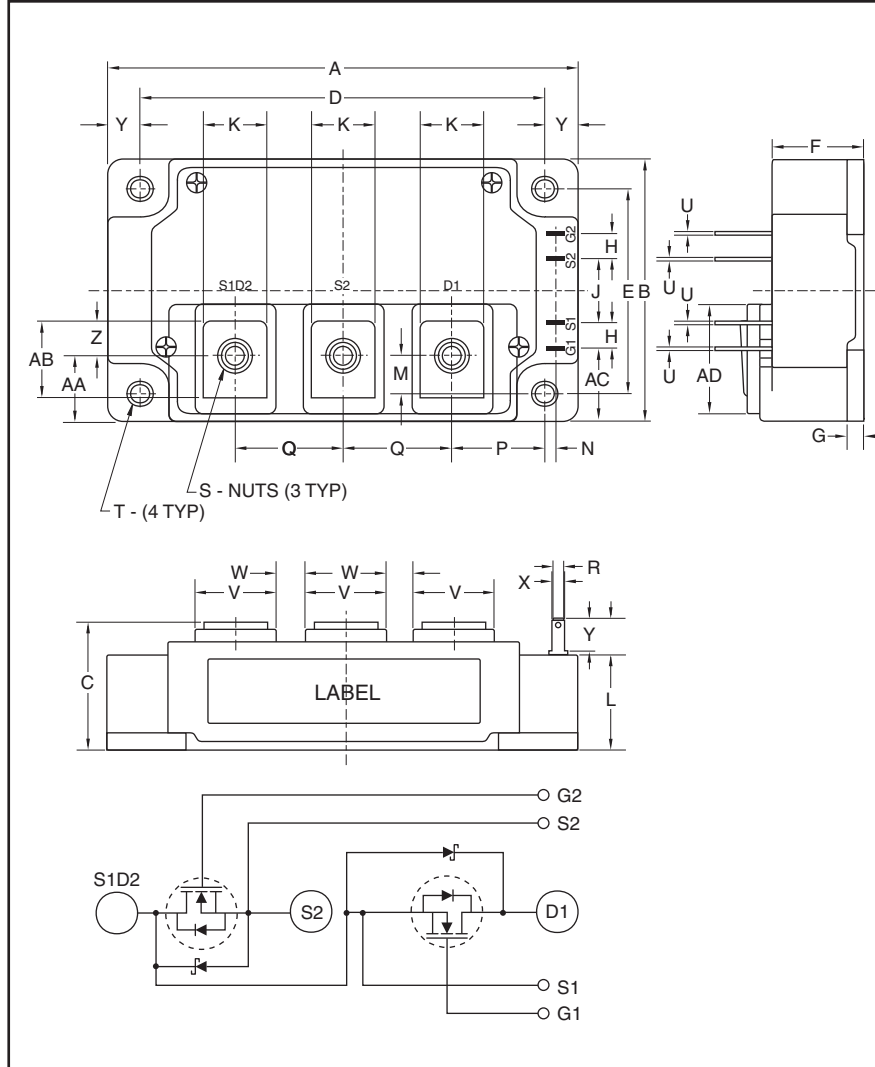

Description:

Powerex Silicon Carbide MOSFET Modules are designed for use in high frequency application. Each module consists of two MOSFET Silicon Carbide Transistors in half-bridge configuration with each transistor having a reverse connected fast recovery free-wheel silicon carbide Schottky diode. All components and interconnects are isolated from the heat sinking baseplate, offering simplified system assembly and thermal management.

Features:

- Junction Temperature - 200°C
- Silicon Carbide Chips
- Industry Leading RDS(on)
- High Speed Switching
- Low Switching Losses
- Low Capacitance
- Low Drive Requirement
- Fast 100A Free Wheeling Schottky Diode
- High Power Density
- Isolated Baseplate
- Aluminum Nitride Ceramic

Applications:

- High Frequency Power Supply
- High Efficiency Inverter
- High Temperature Environment

Outline Drawing and Circuit Diagram

Dimensions	Inches	Millimeters
A	4.25	108.0
B	2.44	62.0
C	1.14+0.04/-0.01	29.0+1.0/-0.5
D	3.66±0.01	93.0±0.25
E	1.88±0.01	48.0±0.25
F	0.67	17.0
G	0.16	4.0
H	0.24	6.0
J	0.59	15.0
K	0.55	14.0
L	0.87	22.0
M	0.33	8.5
N	0.10	2.5
P	0.85	21.5

Dimensions	Inches	Millimeters
Q	0.98	25.0
R	0.11	2.8
S	M6 Metric	M6
T	0.26 Dia.	Dia. 6.5
U	0.02	0.5
V	0.71	18.0
W	0.28	7.0
X	0.16	4.0
Y	0.3	7.5
Z	0.325	8.25
AA	0.624	15.85
AB	0.709	18.0
AC	0.69	17.5
AD	1.012	25.7

QJD1210007
Silicon Carbide MOSFET Module
 100 Amperes/1200 Volts

Absolute Maximum Ratings, $T_j = 25\text{ }^\circ\text{C}$ unless otherwise specified

Ratings	Symbol	QJD1210007	Units
Drain-Source Voltage (G-S Short)	V_{DSS}	1200	Volts
Gate-Source Voltage	V_{GSS}	-5 / +20	Volts
Drain Current (Continuous) at $T_C = 150\text{ }^\circ\text{C}$	I_D	100	Amperes
Drain Current (Pulsed)*	$I_{D(pulse)}$	250	Amperes
Maximum Power Dissipation ($T_C = 25\text{ }^\circ\text{C}$, $T_j < 175\text{ }^\circ\text{C}$)	P_D	880	Watts
Junction Temperature	T_j	-40 to 200	$^\circ\text{C}$
Storage Temperature	T_{stg}	-40 to 150	$^\circ\text{C}$
Mounting Torque, M6 Main Terminal Screws	—	40	in-lb
Mounting Torque, M6 Mounting Screws	—	40	in-lb
Module Weight (Typical)	—	400	Grams
V Isolation Voltage	V_{RMS}	3000	Volts

MOSFET Characteristics, $T_j = 25\text{ }^\circ\text{C}$ unless otherwise specified

Characteristics	Symbol	Test Conditions	Min.	Typ.	Max.	Units
Drain-Source Breakdown Voltage	$V_{(BR)DSS}$	$I_D = 50\mu\text{A}$, $V_{GS} = 0$	1200	—	—	Volts
Zero Gate Voltage Drain Current**	I_{DSS}	$V_{GS} = 0$, $V_{DS} = 1200\text{V}$	—	0.5	50	μA
Zero Gate Voltage Drain Current**	I_{DSS}	$V_{GS} = 0$, $V_{DS} = 1200\text{V}$, $T_j = 175\text{ }^\circ\text{C}$	—	50	—	μA
Gate Leakage Current	I_{GSS}	$V_{DS} = 0$, $V_{GS} = 20\text{V}$	—	—	500	nA
Gate Threshold Voltage	$V_{GS(th)}$	$V_{DS} = V_{GS}$, $I_D = 5\text{mA}$	1.5	2.0	2.5	Volts
		$V_{DS} = V_{GS}$, $I_D = 5\text{mA}$, $T_j = 175\text{ }^\circ\text{C}$	—	1.1	—	Volts
Drain-Source On Resistance	$R_{DS(on)}$	$I_D = 100\text{A}$, $V_{GS} = 20\text{V}$	—	15	25	m Ω
		$I_D = 100\text{A}$, $V_{GS} = 20\text{V}$, $T_j = 175\text{ }^\circ\text{C}$	—	20	32	m Ω
Gate to Source Charge	Q_{gs}	$V_{DD} = 800\text{V}$, $I_D = 100\text{A}$	—	140	—	nC
Gate to Drain Charge	Q_{gd}	$V_{DD} = 800\text{V}$, $I_D = 100\text{A}$	—	220	—	nC
Total Gate Charge	Q_G	$V_{CC} = 800\text{V}$, $I_C = 100\text{A}$, $V_{GS} = -5/20\text{V}$	—	500	—	nC
Body Diode Forward Voltage	V_{SD}	$I_F = 100\text{A}$, $V_{GS} = -5\text{V}$	—	4.3	—	Volts
Input Capacitance	C_{iss}		—	10.2	—	nF
Output Capacitance	C_{oss}	$V_{GS} = 0$, $V_{DS} = 800\text{V}$, $f = 1\text{MHz}$	—	1.0	—	nF
Reverse Transfer Capacitance	C_{rss}		—	0.1	—	nF
Turn-on Delay Time	$t_{d(on)}$	$V_{DD} = 800\text{V}$, $I_D = 100\text{A}$,	—	—	TBD	ns
Rise Time	t_r	$V_{GS} = 0/20\text{V}$,	—	—	TBD	ns
Turn-off Delay Time	$t_{d(off)}$	$R_G = 10\Omega$,	—	—	TBD	μs
Fall Time	t_f	$R_L = 856\mu\text{H}$	—	—	TBD	ns

* Pulse width and repetition rate should be such that device junction temperature (T_j) does not exceed $T_{j(max)}$ rating.

**Total module leakage includes MOSFET leakage plus reverse Schottky diode leakage.

QJD1210007
Silicon Carbide MOSFET Module
 100 Amperes/1200 Volts

Reverse Schottky Diode Characteristics, $T_j = 25^\circ\text{C}$ unless otherwise specified

Characteristics	Symbol	Test Conditions	Min.	Typ.	Max.	Units
Diode Forward Voltage	V_{FM}	$I_F = 100\text{A}, V_{GS} = -5\text{V}$	—	1.6	2.0	Volts
		$I_F = 100\text{A}, V_{GS} = -5\text{V}, T_j = 175^\circ\text{C}$	—	2.5	3.2	Volts
Diode Reverse Current	I_R	$V_R = 1200\text{V}$	—	320	2000	μA
		$V_R = 1200, T_j = 150^\circ\text{C}$	—	560	10000	μA
Diode Capacitive Charge	Q_C	$V_R = 1200\text{V}, I_F = 100\text{A}, di/dt = 4000\text{A}/\mu\text{s}$	—	800	—	nC

Thermal and Mechanical Characteristics, $T_j = 25^\circ\text{C}$ unless otherwise specified

Characteristics	Symbol	Test Conditions	Min.	Typ.	Max.	Units
Thermal Resistance, Junction-to-Case	$R_{th(j-c)}$	MOSFET Part	—	0.17	—	$^\circ\text{C}/\text{W}$
Thermal Resistance, Junction-to-Case	$R_{th(j-c)}$	Diode Part	—	0.14	—	$^\circ\text{C}/\text{W}$
Contact Thermal Resistance	$R_{th(c-s)}$	Per 1/2 Module, Thermal Grease Applied	—	0.04	—	$^\circ\text{C}/\text{W}$

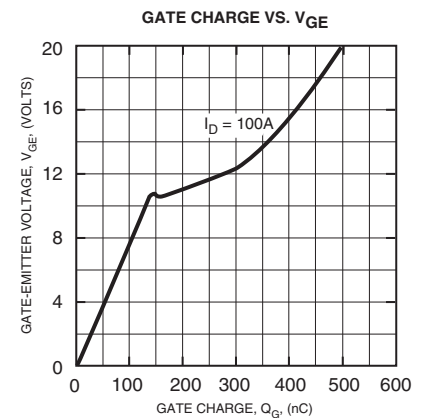
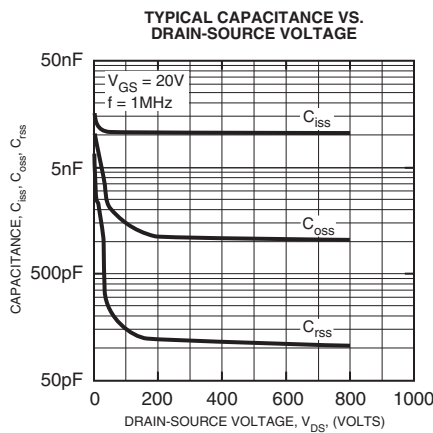
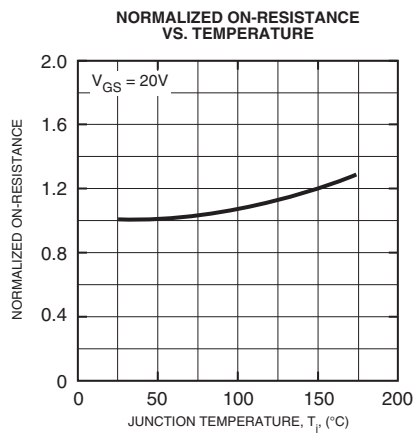
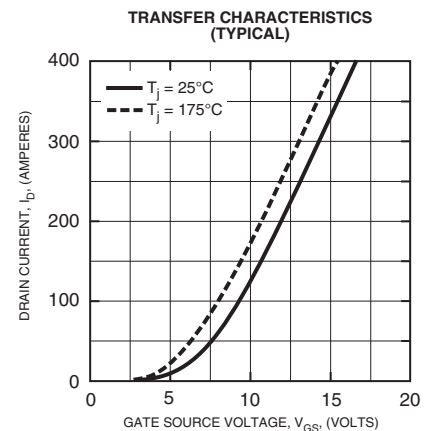
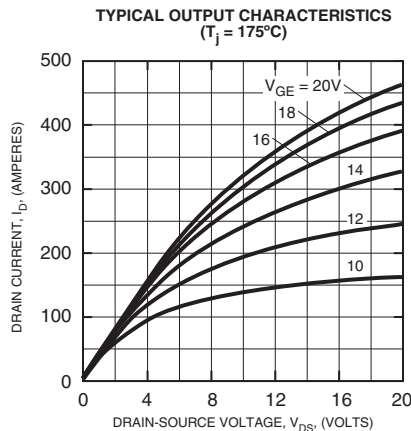
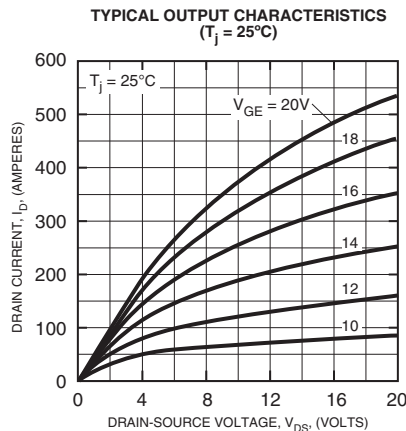

QJD1210007
Silicon Carbide MOSFET Module
 100 Amperes/1200 Volts

FREE-WHEEL SCHOTTKY DIODE FORWARD CHARACTERISTICS (TYPICAL)

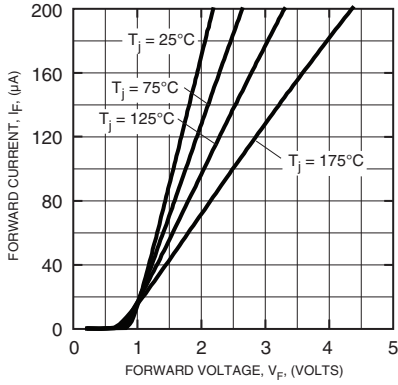

FREE-WHEEL SCHOTTKY DIODE REVERSE CHARACTERISTICS (TYPICAL)

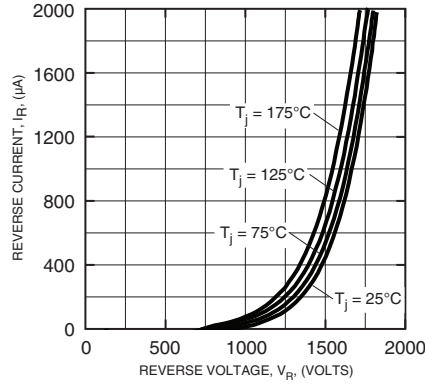

TRANSIENT THERMAL IMPEDANCE CHARACTERISTICS (MOSFET)

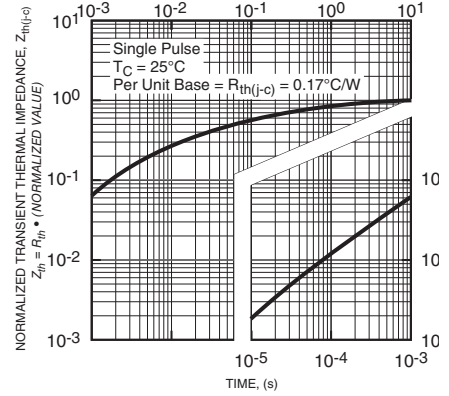

TRANSIENT THERMAL IMPEDANCE CHARACTERISTICS (FWD)

