

**Description:**

The Powerex POW-R-PAK™ is a configurable IGBT based power assembly that may be used as a converter, chopper, half or full bridge, or three phase inverter for motor control, power supply, UPS or other power conversion applications.

The power assembly is mounted on a forced air-cooled heatsink and features state-of-the-art Powerex F-series trench gate IGBTs with low conduction and switching losses for high efficiency operation. The POW-R-PAK™ includes a low inductance laminated bus structure, optically isolated gate drive interfaces, isolated gate drive power supplies, and a DC-link capacitor bank. The control board provides a simple user interface along with built-in protection features including overvoltage, undervoltage lockout, overcurrent, overtemperature, and short circuit detection.

Depending on application characteristics the POW-R-PAK™ is suitable for operation with DC bus voltages up to 800VDC and switching frequencies above 20kHz.

**Schematic****Features:**

- High performance IGBT inverter bridge
- Integrated gate drive with fault monitoring & protection
- System status / troubleshooting LEDs to verify or monitor proper operation
- Isolated gate drive power supplies
- Low inductance laminated bus
- Output current measurement & feedback
- Superior short circuit detection & shoot through prevention

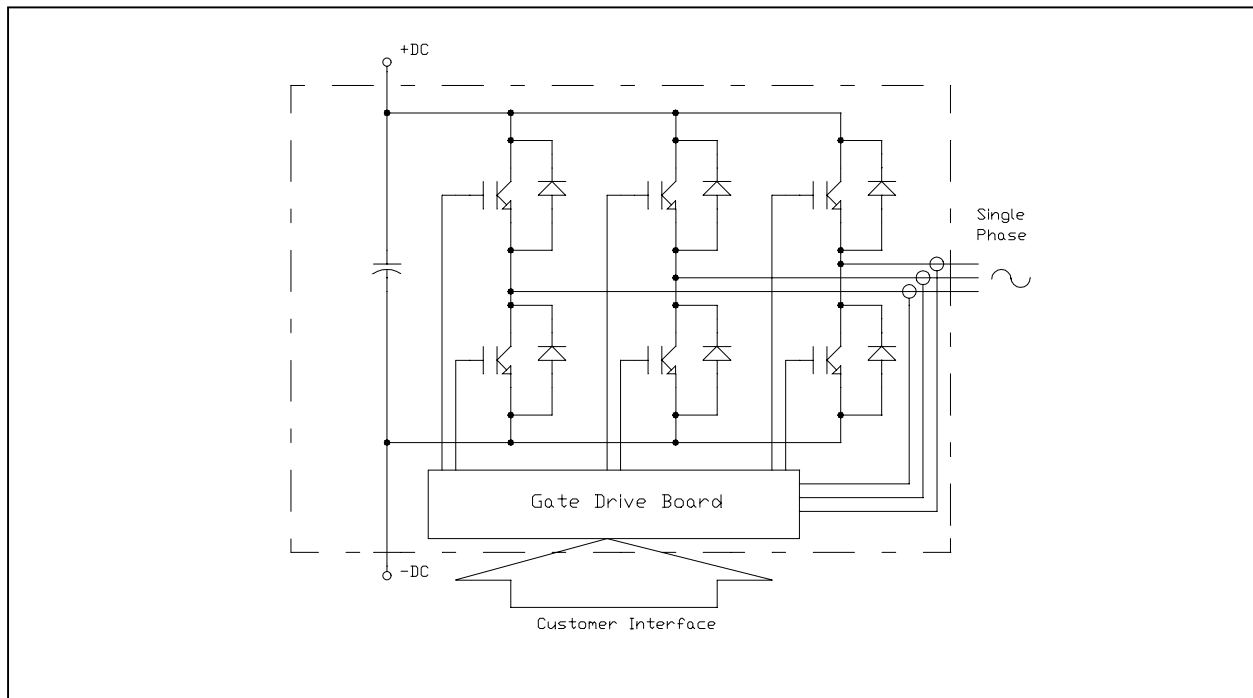

**Absolute Maximum Ratings,  $T_j = 25^\circ\text{C}$  unless otherwise specified**

General	Symbol		Units
IGBT Junction Temperature	$T_j$	-40 to +150	$^\circ\text{C}$
Storage Temperature	$T_{stg}$	-40 to +125	$^\circ\text{C}$
Operating Temperature	$T_{op}$	-25 to +85	$^\circ\text{C}$
Voltage Applied to DC terminals	$V_{CC}$	800	Volts
Isolation Voltage, AC 1 minute, 60Hz sinusoidal	$V_{iso}$	2500	Volts
<b>IGBT Inverter</b>			
Collector Current ( $T_c = 25^\circ\text{C}$ )	$I_C$	225	Amperes
Peak Collector Current ( $T_j < 150^\circ\text{C}$ )	$I_{CM}$	450	Amperes
Emitter Current	$I_E$	225	Amperes
Peak Emitter Current	$I_{EM}$	450	Amperes
Maximum Collector Dissipation ( $T_j < 150^\circ\text{C}$ )	$P_c$	1350	Watts
<b>Gate Drive Board</b>			
Unregulated +24V Power Supply		30	Volts
Regulated +15V Power Supply		18	Volts
PWM Signal Input Voltage		20	Volts
Fault Output Supply Voltage		30	Volts
Fault Output Current		50	mA

**IGBT Inverter Electrical Characteristics,  $T_j = 25^\circ\text{C}$  unless otherwise specified**

Characteristics	Symbol	Test Conditions	Min	Typ	Max	Units
Collector Cutoff Current	$I_{CES}$	$V_{CE} = V_{CES}, V_{GE} = 0V$	-	-	1	mA
Collector – Emitter Saturation Voltage	$V_{CE(sat)}$	$I_C = 225A, T_j = 25^\circ\text{C}$	-	1.8	2.4	Volts
		$I_C = 225A, T_j = 125^\circ\text{C}$	-	1.9	-	Volts
Emitter – Collector Voltage	$V_{EC}$	$I_E = 225A$	-	-	3.2	Volts
Inductive Load Switching Times	$t_{d(on)}$		-	-	100	ns
	$t_r$		-	-	50	ns
	$t_{d(off)}$	$V_{CC} = 600V$ $I_C = 225A$	-	-	400	ns
	$t_f$	$V_{GE} = 15V$ $R_G = 4.2\Omega$	-	-	300	ns
Diode Reverse Recovery Time	$t_{rr}$		-	-	150	ns
Diode Reverse Recovery Charge	$Q_{rr}$		-	3.1	-	$\mu\text{C}$
DC Link Capacitance				3300		$\mu\text{F}$

**Gate Drive Board Electrical Characteristics**

Characteristics	Min	Typ	Max	Units
Unregulated +24V Power Supply	20	24	30	Volts
Regulated +15V Power Supply	14.4	15	18	Volts
PWM Input On Threshold	12	15		Volts
PWM Input Off Threshold		0	2	Volts
Output Overcurrent Trip		337.5		Amperes
Overtemperature Trip	96	98	100	°C
Overvoltage Trip		920		Volts
DC Link Voltage Feedback	See Figure Below			Volts
Heatsink Temperature Feedback	See Figure Below			Volts
Output Current Feedback	See Figure Below			Volts

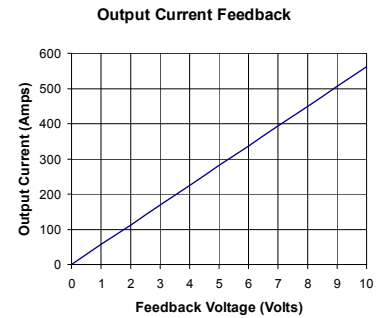

**Thermal and Mechanical Characteristics**

Characteristics	Symbol	Test Conditions	Min	Typ	Max	Units
IGBT Thermal Resistance, Junction to Case	$R_{th(j-c)Q}$	Per IGBT ½ module	-	0.19	0.28	°C/W
FWD Thermal Resistance, Junction to Case	$R_{th(j-c)D}$	Per FWD ½ module			0.47	°C/W
Contact Thermal Resistance	$R_{th(c-f)}$		-	0.045	-	°C/W
Heatsink Thermal Resistance	$R_{th(f-a)}$	1000 LFM airflow		0.040		°C/W
Mounting Torque, AC terminals				75	90	in-lb
Mounting Torque, DC terminals				130	150	in-lb
Mounting Torque, Mounting plate				130	150	in-lb
Weight				21		lb

**Gate Drive Board Interface Signal Definitions**

Pin	Signal Name	Description
1	Shield	Connected to circuit ground
2	PWM -	0-15 V signal controlling the duty cycle of - IGBT
3	Phase Error <sup>1</sup>	Open collector output, external pull-up resistor required LOW = No Error; Floating = Phase overcurrent or short circuit
4	PWM +	0-15 V signal controlling the duty cycle of + IGBT
5	Overtemp <sup>1</sup>	Open collector output, external pull-up resistor required LOW = No Error; Floating = heatsink overtemp
6	24 VDC input power <sup>2</sup>	20 – 30 VDC input voltage range
7	24 VDC input power <sup>2</sup>	20 – 30 VDC input voltage range
8	15 VDC input power <sup>2</sup>	14.4 – 18 VDC input voltage range
9	15 VDC input power <sup>2</sup>	14.4 – 18 VDC input voltage range
10	GND	Ground reference for 15 and 24 VDC inputs
11	GND	Ground reference for 15 and 24 VDC inputs
12	Heatsink Temperature	Analog voltage representation of heatsink temperature
13	GND <sup>3</sup>	Ground reference for analog signals
14	I <sub>out</sub>	Analog voltage representation of output current
15 <sup>4</sup>	GND <sup>3</sup>	Ground reference for analog signals
16 <sup>4</sup>	DC Link Voltage	Analog voltage representation of DC link voltage

**Notes:**

1. Open collectors can be pulled up to 30 V max and sink 50mA continuous.
2. Do not connect a 15 VDC and 24 VDC source to the unit at the same time, use one or the other.
3. GND signals to be used for analog feedback signals, i.e. twisted pair with I<sub>out</sub>
4. Optional outputs for DC link voltage feedback

**Gate Drive Board Interface Connector**

Description	Symbol	Type	Manufacturer
<b>With DC Link Voltage Feedback Option</b>			
Gate Drive Board Interface Header	J1	0.100" x 0.100" latching header, 16 pin	3M# 3408-6002 or equivalent
Recommended Mating Socket	-	0.100" x 0.100" IDC socket, 16 pin	3M# 3452-7600 or equivalent
Recommended Strain Relief	-	Plastic strain relief	3M# 3448-3014 or equivalent
<b>Without DC Link Voltage Feedback Option</b>			
Gate Drive Board Interface Header	J1	0.100" x 0.100" latching header, 14 pin	3M# 3314-6002 or equivalent
Recommended Mating Socket	-	0.100" x 0.100" IDC socket, 14 pin	3M# 3385-7600 or equivalent
Recommended Strain Relief	-	Plastic strain relief	3M# 3448-3014 or equivalent

Performance Curves

Effective Output Current vs. Carrier Frequency (Typical)

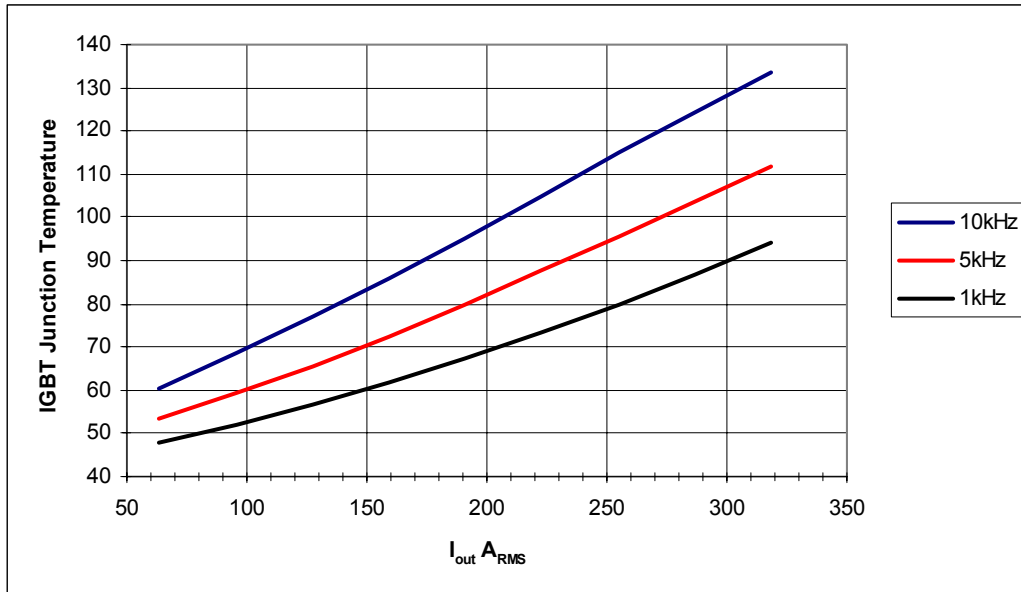

Condition	Symbol	Value	Units
Ambient Temperature	$T_A$	40	°C
DC Bus Voltage	$V_{CC}$	600	Volts
Load Power Factor	$\cos \phi$	0.8	
IGBT Saturation Voltage	$V_{CE(sat)}$	Typical @ $T_J = 125^\circ\text{C}$	Volts
IGBT Switching Loss	$E_{SW}$	Typical @ $T_J = 125^\circ\text{C}$	mJ
Airflow	-	1000	LFM
Switching Conditions	3 phase PWM, 60Hz sinusoidal output		

**Mechanical Drawing**

