

PM75RVA060

FLAT-BASE TYPE
INSULATED PACKAGE

PM75RVA060



FEATURE

- 3φ 75A, 600V Current-sense IGBT for 20kHz switching
- 30A, 600V Current-sense regenerative brake IGBT
- Monolithic gate drive & protection logic
- Detection, protection & status indication circuits for over-current, short-circuit, over-temperature & under-voltage
- Acoustic noise-less 7.5kW class inverter application
- UL Recognized
Yellow Card No. E80276(N)
File No. E80271

APPLICATION

General purpose inverter, servo drives and other motor controls

PACKAGE OUTLINES

Dimensions in mm

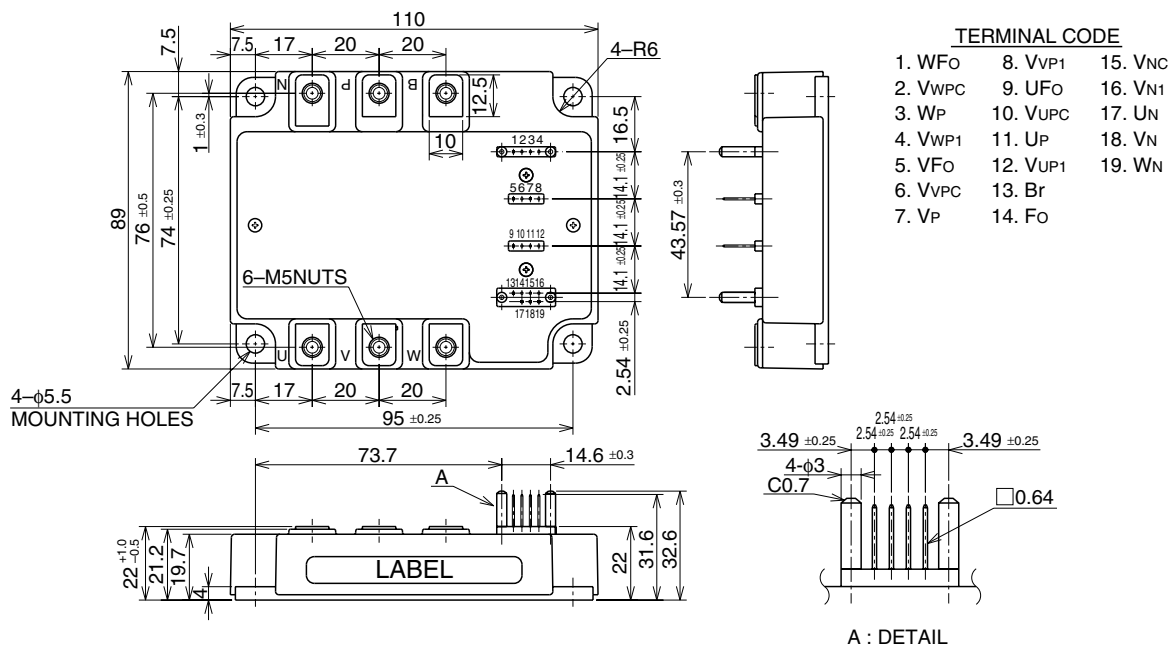

PM75RVA060

FLAT-BASE TYPE
INSULATED PACKAGE

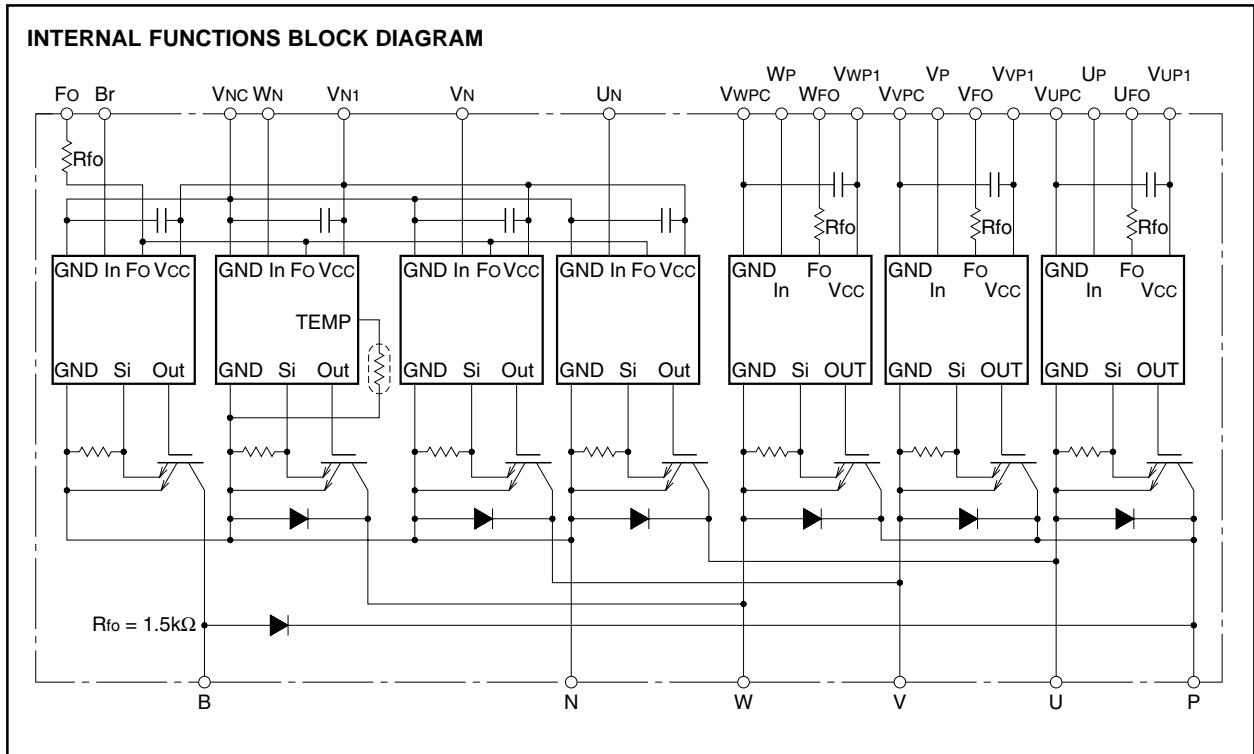

MAXIMUM RATINGS ($T_j = 25^\circ\text{C}$, unless otherwise noted)

INVERTER PART

Symbol	Parameter	Condition	Ratings	Unit
V_{CES}	Collector-Emitter Voltage	$V_D = 15\text{V}$, $V_{CIN} = 15\text{V}$	600	V
$\pm I_C$	Collector Current	$T_c = 25^\circ\text{C}$	75	A
$\pm I_{CP}$	Collector Current (Peak)	$T_c = 25^\circ\text{C}$	150	A
P_C	Collector Dissipation	$T_c = 25^\circ\text{C}$	284	W
T_j	Junction Temperature		$-20 \sim +150$	$^\circ\text{C}$

BRAKE PART

Symbol	Parameter	Condition	Ratings	Unit
V_{CES}	Collector-Emitter Voltage	$V_D = 15\text{V}$, $V_{CIN} = 15\text{V}$	600	V
I_C	Collector Current	$T_c = 25^\circ\text{C}$	30	A
I_{CP}	Collector Current (Peak)	$T_c = 25^\circ\text{C}$	60	A
P_C	Collector Dissipation	$T_c = 25^\circ\text{C}$	178	W
$V_{R(DC)}$	FWDi Rated DC Reverse Voltage	$T_c = 25^\circ\text{C}$	600	V
I_F	FWDi Forward Current	$T_c = 25^\circ\text{C}$	30	A
T_j	Junction Temperature		$-20 \sim +150$	$^\circ\text{C}$

CONTROL PART

Symbol	Parameter	Condition	Ratings	Unit
V_D	Supply Voltage	Applied between : $V_{UP1}-V_{UPC}$ $V_{VP1}-V_{VPC}$, $V_{WP1}-V_{WPC}$, $V_{N1}-V_{NC}$	20	V
V_{CIN}	Input Voltage	Applied between : U_P-V_{UPC} , V_P-V_{VPC} W_P-V_{WPC} , $U_N \cdot V_N \cdot W_N \cdot B_r-V_{NC}$	20	V
V_{FO}	Fault Output Supply Voltage	Applied between : $U_{FO}-V_{UPC}$, $V_{FO}-V_{VPC}$, $W_{FO}-V_{WPC}$ F_O-V_{NC}	20	V
I_{FO}	Fault Output Current	Sink current at U_{FO} , V_{FO} , W_{FO} and F_O terminal	20	mA

PM75RVA060

FLAT-BASE TYPE
INSULATED PACKAGE

TOTAL SYSTEM

Symbol	Parameter	Condition	Ratings	Unit
V _{CC(Prot)}	Supply Voltage Protected by SC	V _D = 13.5 ~ 16.5V, Inverter Part, T _j = 125°C Start	400	V
V _{CC(surge)}	Supply Voltage (Surge)	Applied between : P-N, Surge value or without switching	500	V
T _c	Module Case Operating Temperature	(Note-1)	-20 ~ +100	°C
T _{stg}	Storage Temperature		-40 ~ +125	°C
V _{iso}	Isolation Voltage	60Hz, Sinusoidal, Charged part to Base, AC 1 min.	2500	V _{rms}

(Note-1) T_c measurement point is below. (3mm depth at the center of the side of base plate)

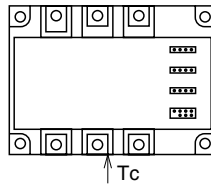

ELECTRICAL CHARACTERISTICS (T_j = 25°C, unless otherwise noted)

INVERTER PART

Symbol	Parameter	Test Condition	Limits			Unit	
			Min.	Typ.	Max.		
V _{CE(sat)}	Collector-Emitter Saturation Voltage	V _D = 15V, I _C = 75A V _{CIN} = 0V	T _j = 25°C	—	2.35	3.80	V
			T _j = 125°C	—	2.55	3.05	
V _{EC}	FWDi Forward Voltage	-I _C = 75A, V _D = 15V, V _{CIN} = 15V	—	2.20	3.30	V	
t _{on}	Switching Time	V _D = 15V, V _{CIN} = 0V↔15V V _{CC} = 300V, I _C = 75A T _j = 125°C Inductive Load (upper and lower arm)	0.4	0.8	2.1	μs	
t _{tr}			—	0.2	0.3		
t _{c(on)}			—	0.3	1.1		
t _{off}			—	1.8	2.9		
t _{c(off)}			—	0.6	1.2		
I _{CES}	Collector-Emitter Cutoff Current	V _{CE} = V _{CES} , V _{CIN} = 15V	T _j = 25°C	—	—	1	mA
			T _j = 125°C	—	—	10	

BRAKE PART

Symbol	Parameter	Test Condition	Limits			Unit	
			Min.	Typ.	Max.		
V _{CE(sat)}	Collector-Emitter Saturation Voltage	V _D = 15V, I _C = 30A V _{CIN} = 0V	T _j = 25°C	—	2.35	2.80	V
			T _j = 125°C	—	2.55	3.05	
V _{FM}	FWDi Forward Voltage	I _F = 30A	—	2.20	3.30	V	
I _{CES}	Collector-Emitter Cutoff Current	V _{CE} = V _{CES} , V _{CIN} = 15V	T _j = 25°C	—	—	1	mA
			T _j = 125°C	—	—	10	

PM75RVA060

FLAT-BASE TYPE
INSULATED PACKAGE

CONTROL PART

Symbol	Parameter	Test Condition	Limits			Unit	
			Min.	Typ.	Max.		
Id	Circuit Current	V _D = 15V, V _{CIN} = 15V	V _{N1} -V _N C	—	44	60	mA
			V*P1-V*PC	—	13	18	
V _{th(ON)}	Input ON Threshold Voltage	Applied between : UP-VUPC, VP-VVPC, WP-VWPC UN • VN • WN • Br-VNC	1.2	1.5	1.8	V	
V _{th(OFF)}	Input OFF Threshold Voltage		1.7	2.0	2.3		
OC	Over Current Trip Level	-20 ≤ T _j ≤ 125°C, V _D = 15V, Break part	39	—	—	A	
SC	Short Circuit Trip Level	-20 ≤ T _j ≤ 125°C, V _D = 15V	Inverter part	115	—	—	A
			Brake part	—	94	—	
toff(OC)	Over Current Delay Time	V _D = 15V, Break part	—	10	—	μs	
toff(SC)	Short Circuit Current Delay Time	V _D = 15V	—	10	—	μs	
OT	Over Temperature Protection	Base-plate Temperature detection, V _D = 15V	Trip level	111	118	125	°C
			Reset level	—	100	—	
UV	Supply Circuit Under-Voltage Protection	-20 ≤ T _j ≤ 125°C	Trip level	11.5	12.0	12.5	V
			Reset level	—	12.5	—	
I _{FO(H)}	Fault Output Current	V _D = 15V, V _{FO} = 15V (Note-2)	—	—	0.01	mA	
I _{FO(L)}			—	10	15		
t _{FO}	Minimum Fault Output Pulse Width	V _D = 15V (Note-2)	1.0	1.8	—	ms	

(Note-2) Fault output is given only when the internal SC, OT & UV protection.
Fault output of OT protection operate by lower arm.
Fault output of OT, UV protection given pulse while over level.

THERMAL RESISTANCES

Symbol	Parameter	Test Condition	Limits			Unit
			Min.	Typ.	Max.	
R _{th(j-c)Q}	Junction to case Thermal Resistances	Inverter IGBT part (per 1/6 module)	—	—	0.44	°C/W
R _{th(j-c)F}		Inverter FWDi part (per 1/6 module)	—	—	0.96	
R _{th(j-c)Q}		Brake IGBT part	—	—	0.70	
R _{th(j-c)F}		Brake FWDi part	—	—	1.50	
R _{th(c-f)}	Contact Thermal Resistance	Case to fin, Thermal grease applied (per 1 module)	—	—	0.027	

MECHANICAL RATINGS AND CHARACTERISTICS

Symbol	Parameter	Test Condition	Limits			Unit
			Min.	Typ.	Max.	
—	Mounting torque	Mounting part screw : M5	2.5	3.0	3.5	N • m
—	Mounting torque	Main terminal screw : M5	2.5	3.0	3.5	N • m
—	Weight	—	—	560	—	g

RECOMMENDED CONDITIONS FOR USE

Symbol	Parameter	Test Condition	Recommended value	Unit
V _{CC}	Supply Voltage	Applied across P-N terminals	≤ 400	V
V _D	Control Supply Voltage	Applied between : VUP1-VUPC, VVP1-VVPC VWP1-VWPC, VN1-VNC (Note-3)	15 ± 1.5	V
V _{CIN(ON)}	Input ON Voltage	Applied between : UP-VUPC, VP-VVPC, WP-VWPC UN • VN • WN • Br-VNC	≤ 0.8	V
V _{CIN(OFF)}	Input OFF Voltage		≥ 4.0	
t _{dead}	Arm Shoot-through Blocking Time	For IPM's each input signals	≥ 2.5	μs
f _{PWM}	PWM Input Frequency	Using Application Circuit input signal of IPM, Sinusoidal PWM VVVF inverter	≤ 20	kHz

(Note-3) With ripple satisfying the following conditions dv/dt swing ≤ ±5V/μs, Variation ≤ 2V peak to peak

PM75RVA060

FLAT-BASE TYPE
INSULATED PACKAGE

PERFORMANCE CURVES (Inverter Part)

OUTPUT CHARACTERISTICS (TYPICAL)

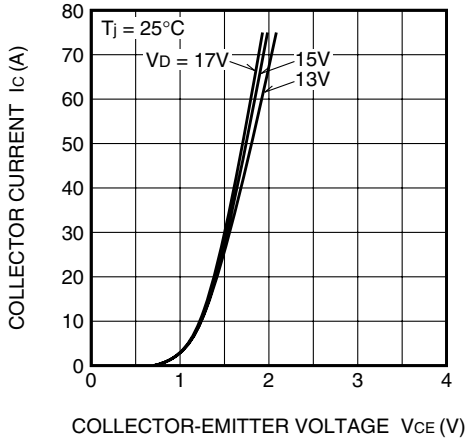

COLLECTOR-EMITTER SATURATION VOLTAGE CHARACTERISTICS (TYPICAL)

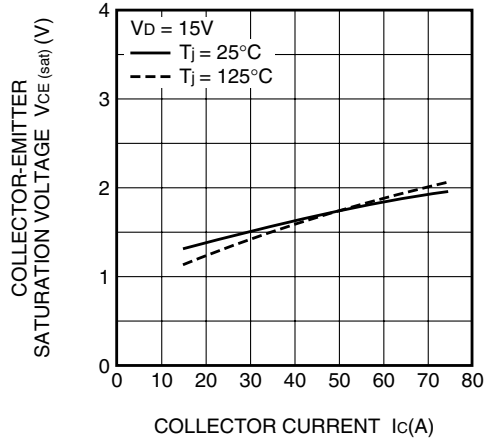

COLLECTOR-EMITTER SATURATION VOLTAGE CHARACTERISTICS (TYPICAL)

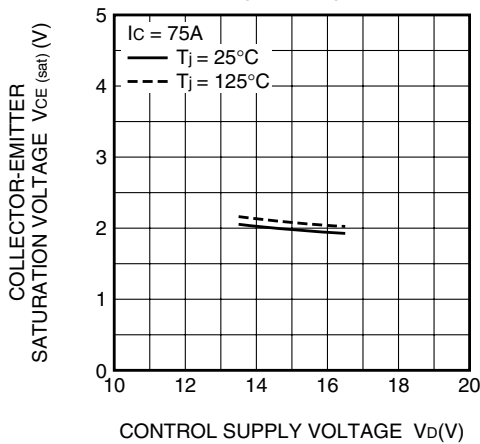

SWITCHING CHARACTERISTICS (TYPICAL)

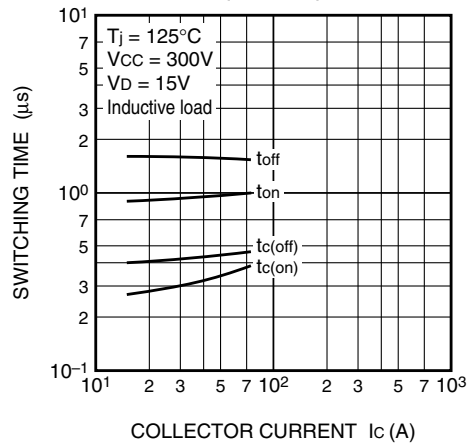

DIODE FORWARD CHARACTERISTICS (TYPICAL)

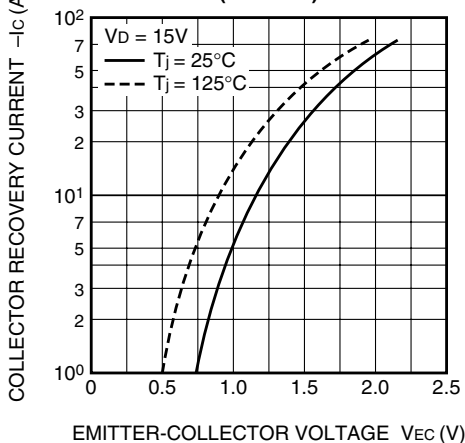

DIODE REVERSE RECOVERY CHARACTERISTICS (TYPICAL)

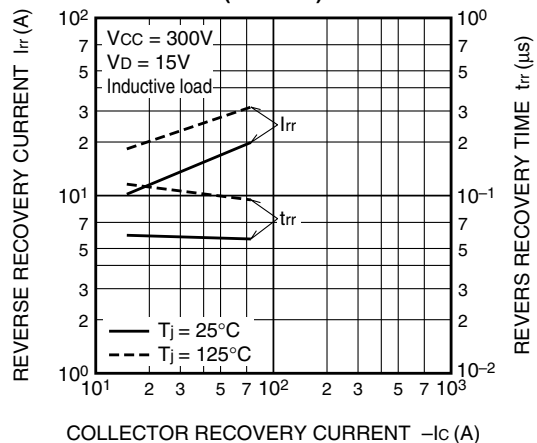

PM75RVA060

FLAT-BASE TYPE
INSULATED PACKAGE

PERFORMANCE CURVES (Inverter Part)

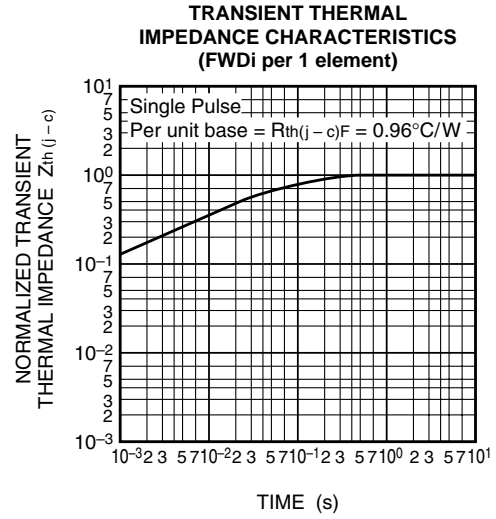
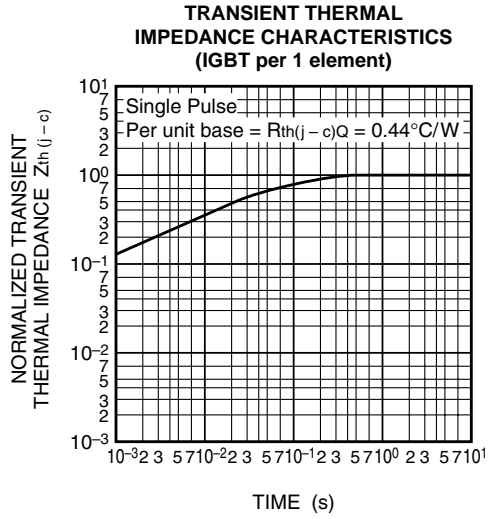

PM75RVA060

FLAT-BASE TYPE
INSULATED PACKAGE

PERFORMANCE CURVES (Brake Part)

OUTPUT CHARACTERISTICS (TYPICAL)

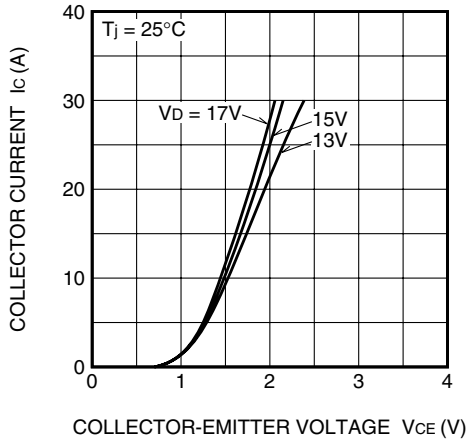

COLLECTOR-EMITTER SATURATION VOLTAGE CHARACTERISTICS (TYPICAL)

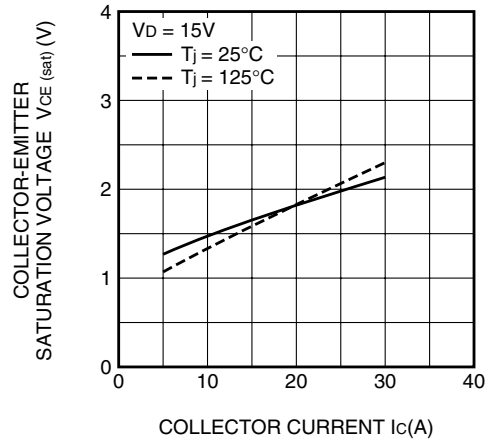

COLLECTOR-EMITTER SATURATION VOLTAGE CHARACTERISTICS (TYPICAL)

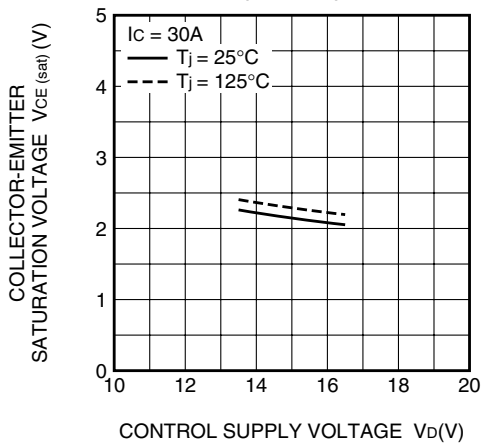

DIODE FORWARD CHARACTERISTICS (TYPICAL)

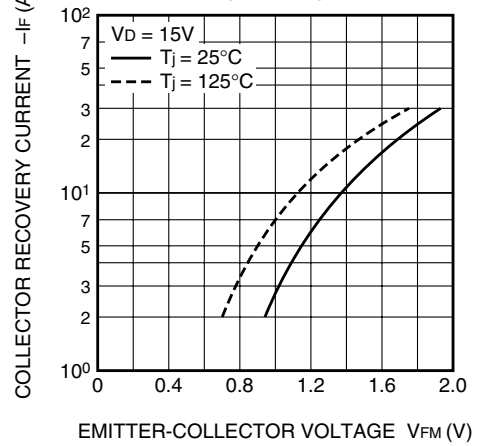

TRANSIENT THERMAL IMPEDANCE CHARACTERISTICS (IGBT part)

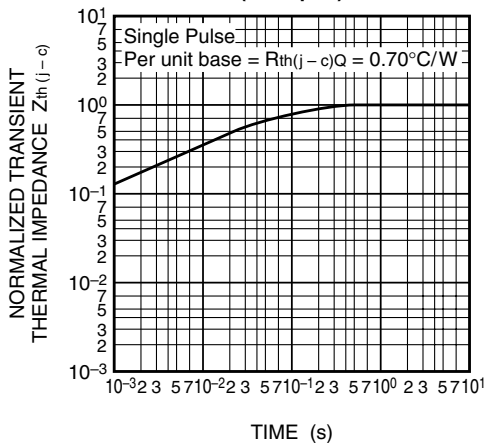

TRANSIENT THERMAL IMPEDANCE CHARACTERISTICS (FWDi part)

