

Powerex, Inc., Hillis Street, Youngwood, Pennsylvania 15697 (412) 925-7272
 Powerex, Europe, S.A. 428 Avenue G. Durand, BP107, 72003 Le Mans, France (43) 41.14.14

Intellimod™-3 Modules
 Three Phase + Brake
 IGBT Inverter Output
 50 Amperes/110-230 Volt Line

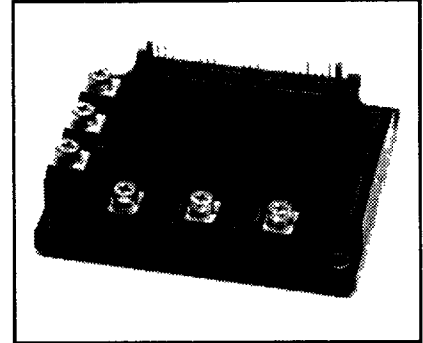
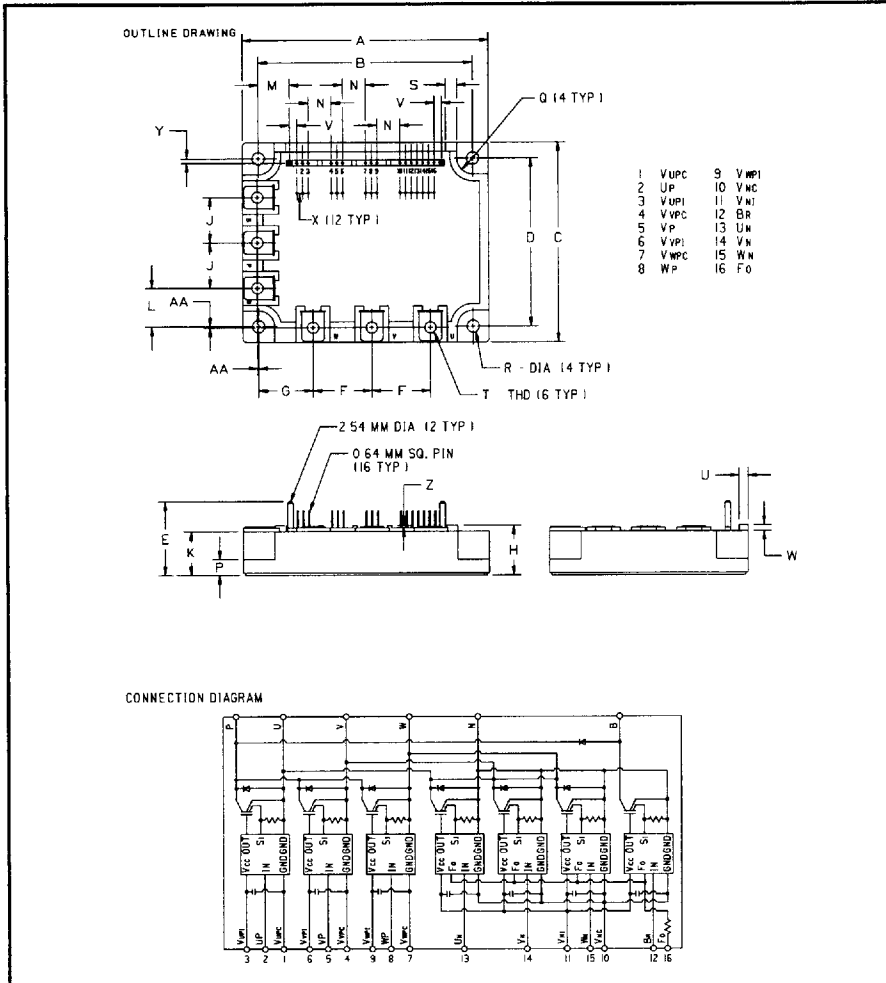

Description

Powerex Intellimod-3 Modules are designed for applications requiring a high frequency (20kHz) output switching inverter. The modules are isolated from the baseplate, consisting of complete drive, control and protection circuitry for the IGBT inverter.

Features:

- Complete Output Power Circuit
- Gate Drive Circuit
- Protection Logic
 - Short Circuit
 - Over-Current
 - Over Temperature
 - Under Voltage

Applications:

- Inverters
- Small UPS
- Motion/Servo Control
- AC Motor Control

Ordering Information
 PM50RHA060

110-230 Volt Line, PM50RHA060 Outline Drawing

Dimensions	Inches	Millimeters
A	4.29±0.04	109.0±1.0
B	3.74±0.02	95.0±0.5
C	3.46±0.04	88.0±1.0
D	2.91±0.02	74.0±0.5
E	1.28	32.6
F	1.02	26.0
G	0.94	24.0
H	0.87	22.0
J	0.79	20.0
K	0.76	19.4
L	0.67	17.0
M	0.54	13.8
N	0.4	10.16

Dimensions	Inches	Millimeters
P	0.28	7.0
Q	0.38 R	7.0 R
R	0.22 Dia.	5.5 Dia.
S	0.2	5.0
T	M5 Metric	M5
U	0.16	4.0
V	0.127	3.22
W	0.1	2.6
X	0.1	2.54
Y	0.08	2.0
Z	0.04	1.0
AA	0.02	0.5



POWEREX INC

51E D ■ 7294621 0005677 T12 ■ PRX

Powerex, Inc., Hillis Street, Youngwood, Pennsylvania 15697 (412) 925-7272
 Powerex, Europe, S.A. 428 Avenue G. Durand, BP107, 72003 Le Mans, France (43) 41.14.14

T-57-29

PM50RHA060
Intellimod-3 Modules
Three Phase + Brake IGBT Inverter Output
 50 Amperes/110-230 Volt Line

Absolute Maximum Ratings, $T_j = 25\text{ }^\circ\text{C}$ unless otherwise specified

Characteristics	Symbol	PM50RHA060	Units
Power Device Junction Temperature	T_j	-20 to +150	$^\circ\text{C}$
Storage Temperature	T_{STG}	-40 to +125	$^\circ\text{C}$
Case Operating Temperature	T_C	-20 to +100	$^\circ\text{C}$
Mounting Torque, M5 Mounting Screws	—	17	Kg-cm
Mounting Torque, M5 Main Terminal Screws	—	17	Kg-cm
Module Weight (Typical)	—	550	Grams
Supply Voltage Protected by OC and SC ($V_D = 13.5 - 16.5\text{V}$, Inverter Part)	$V_{CC(prot.)}$	400	Volts
Isolation Voltage AC 1 minute, 60Hz	V_{RMS}	2500	Volts

Control Sector

Supply Voltage Applied between ($V_{UP1} - V_{UPC}, V_{VP1} - V_{VPC}, V_{WP1} - V_{WPC}, V_{N1} - V_{NC}$)	V_D	20	Volts
Input Voltage Applied between ($U_P, V_P, U_N, V_N, W_N, B_r$)	V_{CIN}	20	Volts
Fault Output Supply Voltage	V_{FO}	20	Volts
Fault Output Current	I_{FO}	20	mA

IGBT Inverter Sector

Collector-Emitter Voltage Fig. 1	V_{CES}	600	Volts
Collector Current \pm	I_C	50	Amperes
Peak Collector Current \pm	I_{CP}	100	Amperes
Supply Voltage (Applied between P - N)	V_{CC}	450	Volts
Supply Voltage (Surge) Applied between P - N	$V_{CC(surge)}$	500	Volts
Collector Dissipation	P_C	138	Watts

Brake Sector

Collector-Emitter Voltage Fig. 1	V_{CES}	600	Volts
Collector Current \pm	I_C	15	Amperes
Peak Collector Current \pm	I_{CP}	30	Amperes
Supply Voltage (Applied between P - N)	V_{CC}	450	Volts
Supply Voltage (Surge) Applied between P - N	$V_{CC(surge)}$	500	Volts
Collector Dissipation	P_C	52	Watts
Diode Forward Current	I_F	15	Amperes
Diode DC Reverse Voltage	$V_{R(DC)}$	600	Volts



POWEREX INC

51E D ■ 7294621 0005678 959 ■ PRX

Powerex, Inc., Hillis Street, Youngwood, Pennsylvania 15697 (412) 925-7272

Powerex, Europe, S.A. 428 Avenue G. Durand, BP107, 72003 Le Mans, France (43) 41.14.14

T-57-29

PM50RHA060

Intellimod-3 Modules

Three Phase + Brake IGBT Inverter Output

50 Amperes/110-230 Volt Line

Electrical Characteristics, $T_j = 25^\circ\text{C}$ unless otherwise specified

Characteristics	Symbol	Test Conditions	Min.	Typ.	Max.	Units
Control Sector						
Overcurrent Trip Level Inverter Part	OC	$-20^\circ\text{C} \leq T \leq 125^\circ\text{C}, V_D = 15\text{V}$	65	88	–	Amperes
Overcurrent Trip Level Brake Part			18	26	–	Amperes
Short Circuit Trip Level Inverter Part	SC	$-20^\circ\text{C} \leq T \leq 125^\circ\text{C}, V_D = 15\text{V}$	–	132	–	Amperes
Short Circuit Trip Level Brake Part			–	39	–	Amperes
Over Current Delay Time	$t_{\text{off(OC)}}$	$V_D = 15\text{V}$, Fig. 7	–	10	–	μS
Over Temperature Protection	OT	Trip Level	111	118	125	$^\circ\text{C}$
Over Temperature Protection	OT_R	Reset Level	–	100	–	$^\circ\text{C}$
Supply Circuit Under Voltage Protection	UV	Trip Level	11.5	12.0	12.5	Volts
Supply Circuit Under Voltage Protection	UV_R	Reset Level	–	12.5	–	Volts
Supply Voltage	V_D	Applied between $V_{\text{UP1}} - V_{\text{UPC}}, V_{\text{VP1}} - V_{\text{VPC}}, V_{\text{WP1}} - V_{\text{WPC}}, V_{\text{N1}} - V_{\text{NC}}$	13.5	15	16.5	Volts
Circuit Current	I_D	$V_D = 15\text{V}, V_{\text{CIN}} = 15\text{V}, V_{\text{N1}} - V_{\text{NC}}$	–	80	120	mA
	I_D	$V_D = 15\text{V}, V_{\text{CIN}} = 15\text{V}, V_{\text{XP1}} - V_{\text{XPC}}$	–	25	35	mA
Input Bias On Voltage	$V_{\text{CIN(on)}}$	Applied between $V_{\text{UP1}} - V_{\text{UPC}}, B_r - V_{\text{NC}}, V_{\text{VP1}} - V_{\text{VPC}}, V_{\text{WP1}} - V_{\text{WPC}}, V_{\text{N1}} - V_{\text{NC}}$	1.2	1.5	1.8	Volts
Input Bias Off Voltage	$V_{\text{CIN(off)}}$	Applied between $V_{\text{UP1}} - V_{\text{UPC}}, B_r - V_{\text{NC}}, V_{\text{VP1}} - V_{\text{VPC}}, V_{\text{WP1}} - V_{\text{WPC}}, V_{\text{N1}} - V_{\text{NC}}$	1.7	2.0	2.3	Volts
PWM Input Frequency	f_{PWM}	3- \emptyset Sinusoidal	–	15	20	kHz
Dead Time	t_{DEAD}	For each Input Pulse	3.0	–	–	μS
		Using example Interface Circuit*	5.0	–	–	μS
Fault Output Current	$I_{\text{FO(H)}}$	$V_D = 15\text{V}, V_{\text{FO}} = 15\text{V}$	–	–	0.01	mA
	$I_{\text{FO(L)}}$	$V_D = 15\text{V}, V_{\text{FO}} = 15\text{V}$	–	10	15	mA
Minimum Fault Output Pulse Width	t_{FO}	$V_D = 15\text{V}$	1.0	2.0	–	mS
		Using example Interface Circuit* $V_D = 15\text{V}$	1.0	2.0	–	mS
Brake Sector						
Collector Emitter Saturation Voltage	$V_{\text{CE(sat)}}$	$V_D = 15\text{V}, I_C = 15\text{A}, T_j = 25^\circ\text{C}$, Fig. 2	–	2.6	3.5	Volts
		$V_D = 15\text{V}, I_C = 15\text{A}, T_j = 125^\circ\text{C}$, Fig. 2	–	3.0	4.0	Volts
Diode Forward Voltage	V_{FM}	$I_C = 15\text{A}, V_D = 15\text{V}, V_{\text{CIN}} = 15\text{V}$, Fig. 3	–	1.7	2.2	Volts
Collector Cutoff Current	I_{CEX}	$V_{\text{CE}} = V_{\text{CES}}, T_j = 25^\circ\text{C}$, Fig. 6	–	–	1	mA
		$V_{\text{CE}} = V_{\text{CES}}, T_j = 125^\circ\text{C}$, Fig. 6	–	–	10	mA

*See Intellimod-3 Applications Data Section 4.3.



POWEREX INC

51E D ■ 7294621 0005679 895 ■ PRX

Powerex, Inc., Hillis Street, Youngwood, Pennsylvania 15697 (412) 925-7272
 Powerex, Europe, S.A. 428 Avenue G. Durand, BP107, 72003 Le Mans, France (43) 41.14.14

T-57-29

PM50RHA060
 Intellimod-3 Modules
 Three Phase + Brake IGBT Inverter Output
 50 Amperes/110-230 Volt Line

Electrical Characteristics, $T_j = 25^\circ\text{C}$ unless otherwise specified

Characteristics	Symbol	Test Conditions	Min.	Typ.	Max.	Units
IGBT Inverter Sector						
Collector Cutoff Current	I_{CEX}	$V_{CE} = V_{CES}, T_j = 25^\circ\text{C}$, Fig. 6	-	-	1	mA
Collector Cutoff Current	I_{CEX}	$V_{CE} = V_{CES}, T_j = 125^\circ\text{C}$, Fig. 6	-	-	10	mA
Diode Forward Voltage	V_{FM}	$-I_C = 50\text{A}, V_D = 15\text{V}, V_{CIN} = 15\text{V}$, Fig. 3	-	1.7	2.5	Volts
Collector Emitter Saturation Voltage	$V_{CE(sat)}$	$V_D = 15\text{V}, I_{CIN} = 0\text{mA}, I_C = 50\text{A}$, Fig. 2	-	2.7	3.5	Volts
Collector Emitter Saturation Voltage	$V_{CE(sat)}$	$V_D = 15\text{V}, V_{CIN} = 0\text{V}, I_C = 50\text{A}$, $T_j = 125^\circ\text{C}$, Fig. 2	-	2.5	3.4	Volts
Inductive Load Switching Times	t_{on}	$V_D = 15\text{V}, V_{CIN} = 0\text{V}$,	0.3	0.6	1.5	μS
	t_{rr}	$V_{CC} = 300\text{V}, I_C = 50\text{A}$,	-	0.25	0.4	μS
	$t_{C(on)}$	$T_j = 125^\circ\text{C}$	-	0.4	1.2	μS
	t_{off}	Fig. 4, 5	-	2.0	3.3	μS
	$t_{C(off)}$		-	0.6	1.2	μS

Thermal Characteristics

Characteristics	Symbol	Test Conditions	Min.	Typ.	Max.	Units
Thermal Resistances Junction to Case	$R_{th(l-c)Q}$	Inverter IGBT	-	-	0.9	$^\circ\text{C/W}$
	$R_{th(l-c)F}$	Inverter FWD	-	-	2.5	$^\circ\text{C/W}$
	$R_{th(l-c)Q}$	Brake IGBT	-	-	2.4	$^\circ\text{C/W}$
	$R_{th(l-c)F}$	Brake FWD	-	-	4.5	$^\circ\text{C/W}$
Contact Thermal Resistance	$R_{th(c-f)}$	Case to Fin, Thermal Grease Applied	-	-	0.19	$^\circ\text{C/W}$

Recommended Operating Conditions

Characteristics	Symbol	Test Conditions	Value	Units
Supply Voltage	V_{CC}	Applied across P - N Terminals	0 ~ 400	Volts
	V_D	Applied between $V_{UP1} - V_{UPC}$, $V_{N1} - V_{NC}$, $V_{VP1} - V_{VPC}$, $V_{WP1} - V_{WPC}$	15±1.5	Volts
Input On Voltage	$V_{CIN(on)}$	Applied between	0 ~ 0.8	Volts
Input Off Voltage	$V_{CIN(off)}$	$U_P, V_P, W_P, U_N, V_N, W_N, B_r$	4 ~ 15	Volts
PWM Input Frequency	f_{PWM}	Using example Interface Circuit *	5 ~ 20	kHz
Minimum Dead Time	t_{DEAD}	Using example Interface Circuit *	5.0	μS

*See Intellimod-3 Applications Data Section 4.3.



POWEREX INC

51E D ■ 7294621 0005680 507 ■ PRX

Powerex, Inc., Hillis Street, Youngwood, Pennsylvania 15697 (412) 925-7272

Powerex, Europe, S.A. 428 Avenue G. Durand, BP107, 72003 Le Mans, France (43) 41.14.14

T-57-29

PM50RHA060

Intellimod-3 Modules

Three Phase + Brake IGBT Inverter Output

50 Amperes/110-230 Volt Line

Inverter Part

SATURATION VOLTAGE CHARACTERISTICS (TYPICAL)

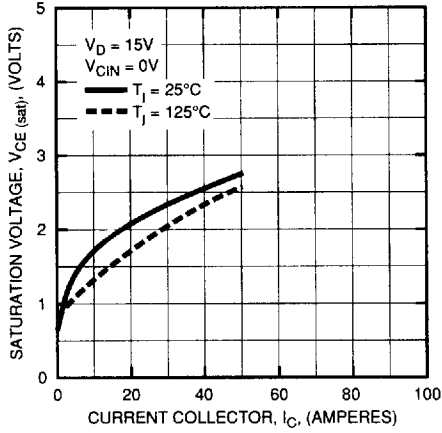

COLLECTOR-EMITTER SATURATION VOLTAGE (TYPICAL)

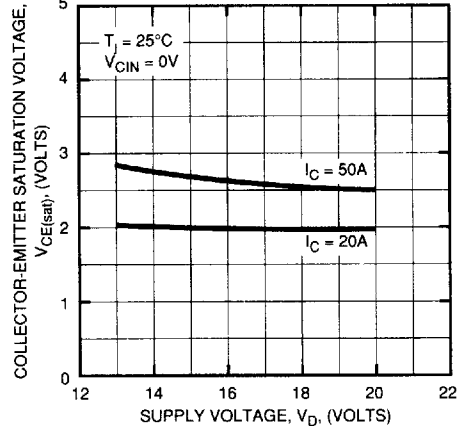

OUTPUT CHARACTERISTICS (TYPICAL)

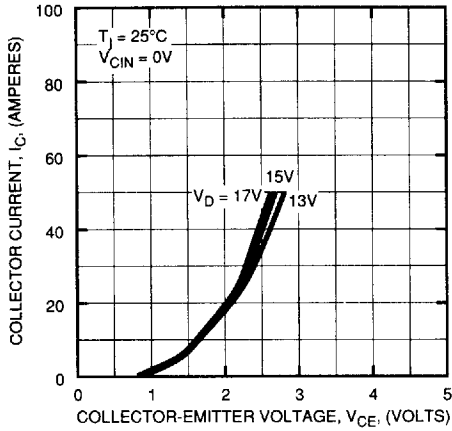

SWITCHING TIME VS. COLLECTOR CURRENT (TYPICAL)

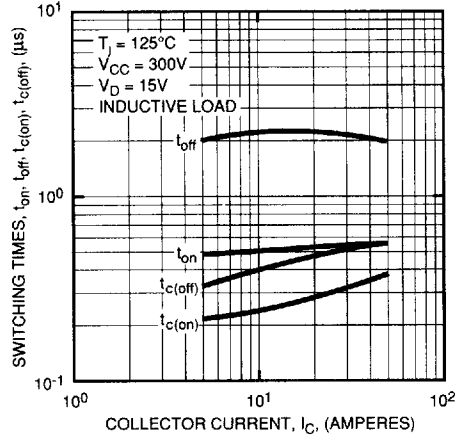

REVERSE RECOVERY CHARACTERISTICS OF FREE-WHEEL DIODE (TYPICAL)

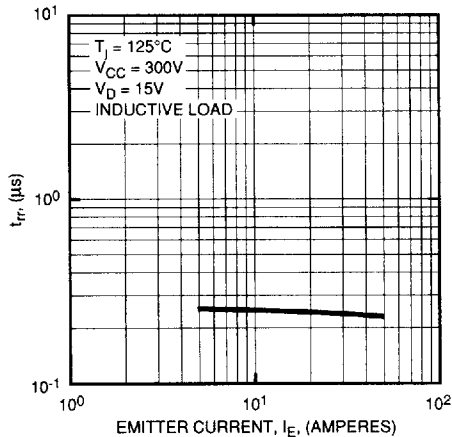

REVERSE COLLECTOR CURRENT VS. EMITTER-COLLECTOR VOLTAGE (DIODE FORWARD CHARACTERISTICS) (TYPICAL)

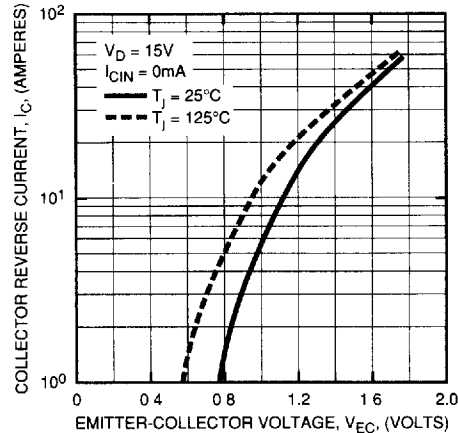



POWEREX INC

51E D ■ 7294621 0005681 443 ■ PRX ■

Powerex, Inc., Hillis Street, Youngwood, Pennsylvania 15697 (412) 925-7272

Powerex, Europe, S.A. 428 Avenue G. Durand, BP107, 72003 Le Mans, France (43) 41.14.14

T-57-29

PM50RHA060

Intellimod-3 Modules

Three Phase + Brake IGBT Inverter Output

50 Amperes/110-230 Volt Line

Inverter Part

POWER DISSIPATION DERATING CURVE
(PER IGBT ELEMENT)

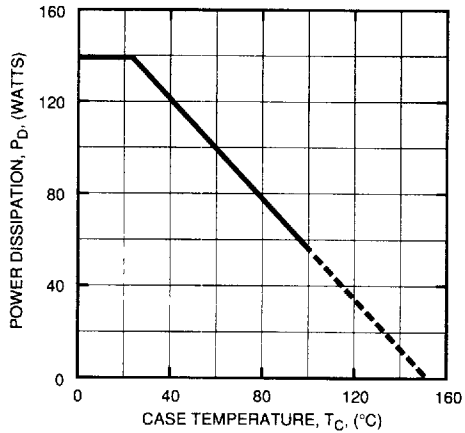

POWER DISSIPATION DERATING CURVE
(PER FWDI ELEMENT)

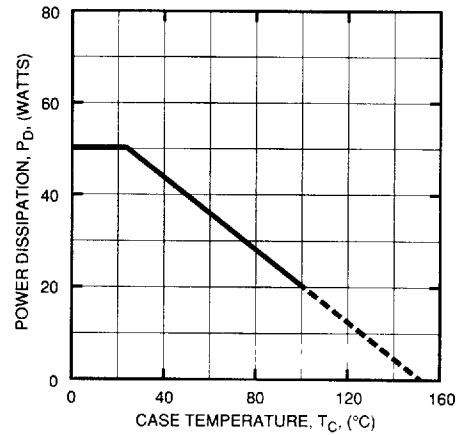

TRANSIENT THERMAL
IMPEDANCE CHARACTERISTICS
(IGBT)

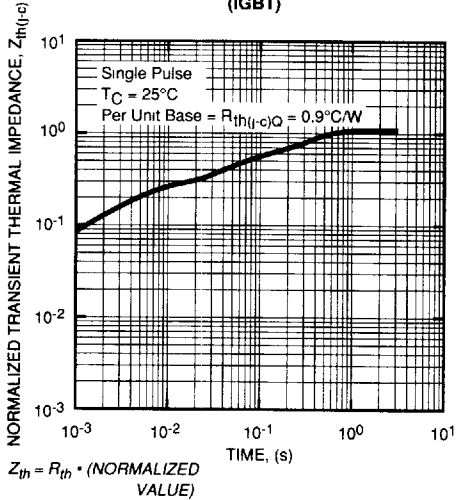

TRANSIENT THERMAL
IMPEDANCE CHARACTERISTICS
(FWDI)

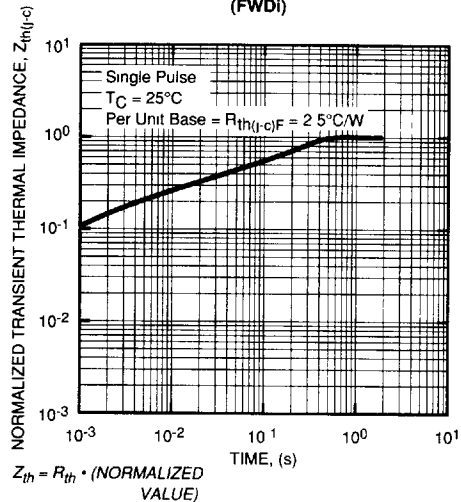

Powerex, Inc., Hillis Street, Youngwood, Pennsylvania 15697 (412) 925-7272
 Powerex, Europe, S.A. 428 Avenue G. Durand, BP107, 72003 Le Mans, France (43) 41.14.14

PM50RHA060
Intellimod-3 Modules
Three Phase + Brake IGBT Inverter Output
50 Amperes/110-230 Volt Line
Brake Part

T-57-29

SATURATION VOLTAGE CHARACTERISTICS (TYPICAL)

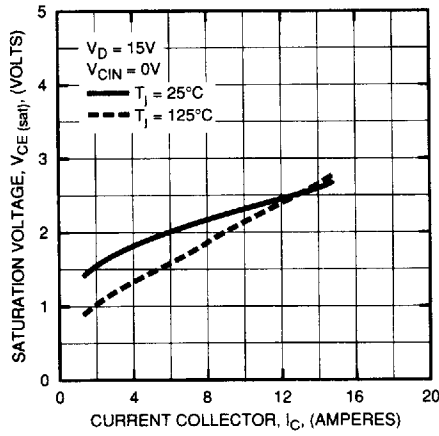

COLLECTOR-EMITTER SATURATION VOLTAGE (TYPICAL)

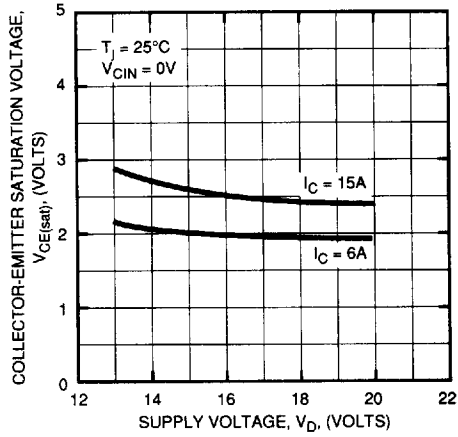

OUTPUT CHARACTERISTICS (TYPICAL)

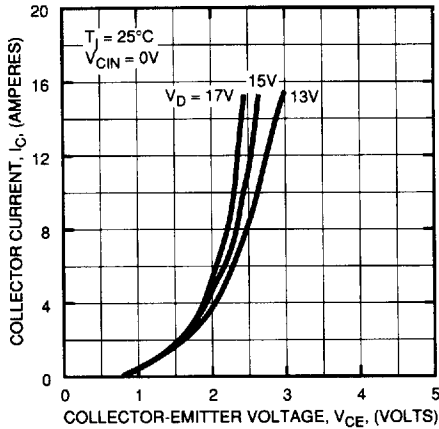

REVERSE COLLECTOR CURRENT VS. EMITTER-COLLECTOR VOLTAGE (DIODE FORWARD CHARACTERISTICS) (TYPICAL)

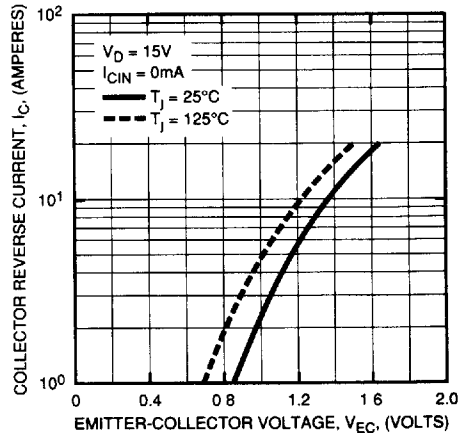



POWEREX INC

SIE D ■ 7294621 0005683 216 ■ PRX

Powerex, Inc., Hillis Street, Youngwood, Pennsylvania 15697 (412) 925-7272

Powerex, Europe, S.A. 428 Avenue G. Durand, BP107, 72003 Le Mans, France (43) 41.14.14

T-57-29

PM50RHA060

Intellimod-3 Modules

Three Phase + Brake IGBT Inverter Output

50 Amperes/110-230 Volt Line

Brake Part

POWER DISSIPATION DERATING CURVE
(PER IGBT ELEMENT)

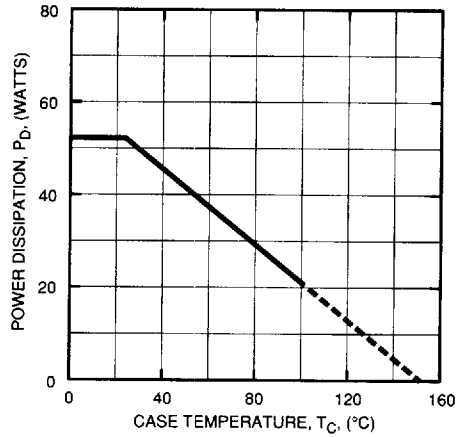

POWER DISSIPATION DERATING CURVE
(PER FWDI ELEMENT)

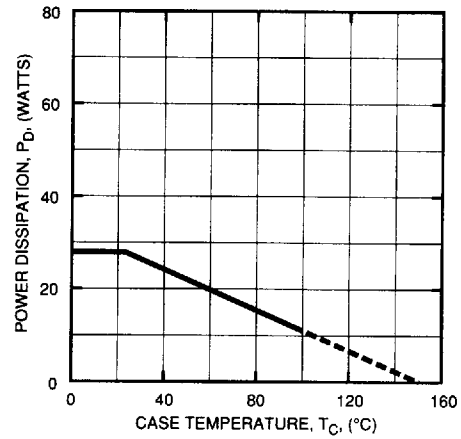

TRANSIENT THERMAL
IMPEDANCE CHARACTERISTICS
(IGBT)

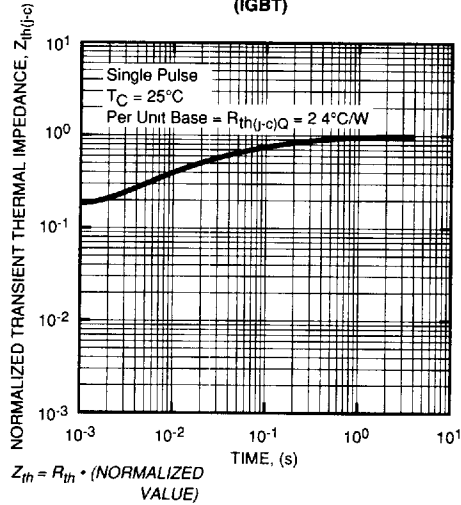

TRANSIENT THERMAL
IMPEDANCE CHARACTERISTICS
(FWDI)

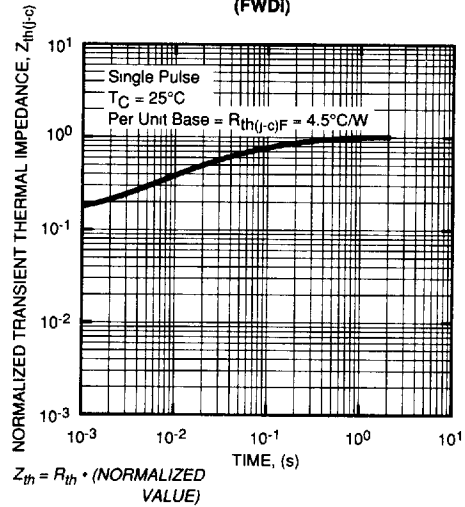

T-57-29

PM50RHA060
Intellimod-3 Modules
Three Phase + Brake IGBT Inverter Output
 50 Amperes/110-230 Volt Line

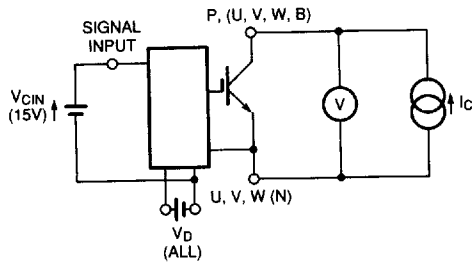

Figure 1 V_{CES} Test

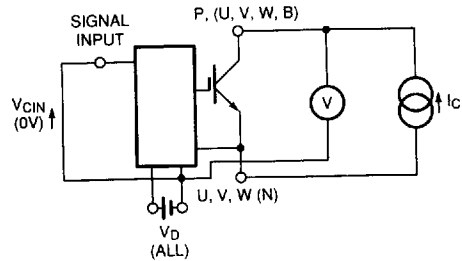

Figure 2 $V_{CE(SAT)}$ Test

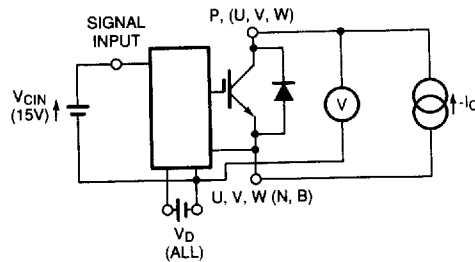
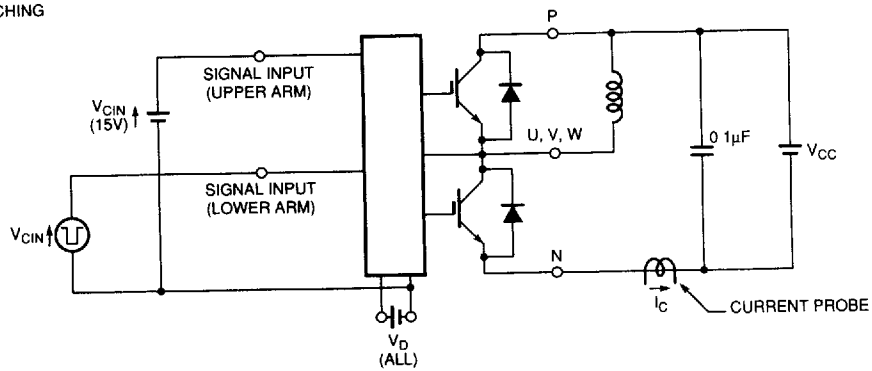

Figure 3 V_{EC} Test

A) LOWER ARM SWITCHING



B) UPPER ARM SWITCHING

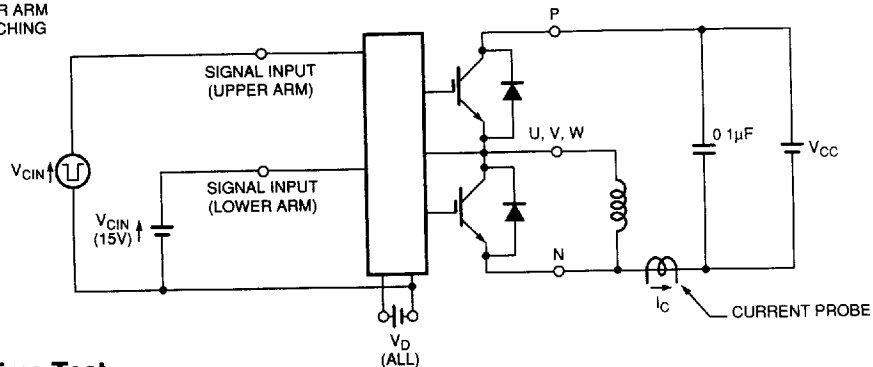

Figure 4 Switching Time Test

T-57-29

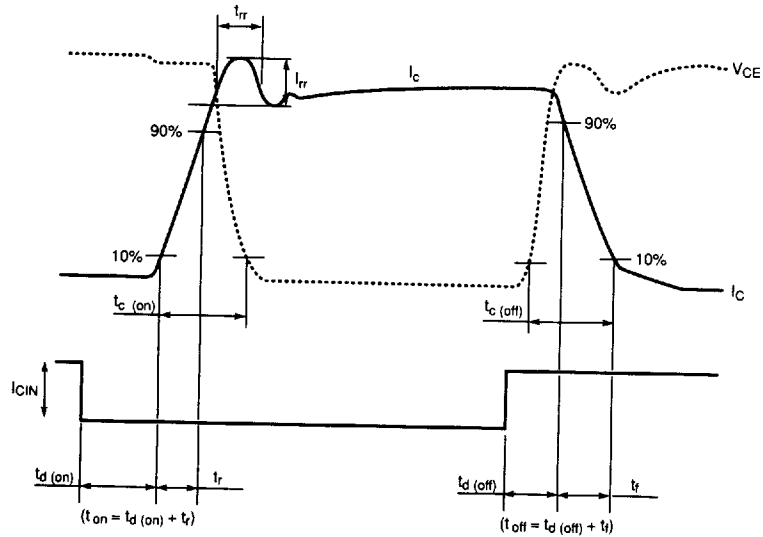

Figure 5 Switching Test Waveform

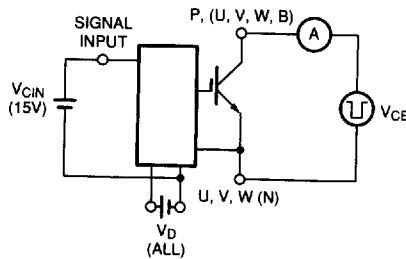

Figure 6 I_{CES} Test

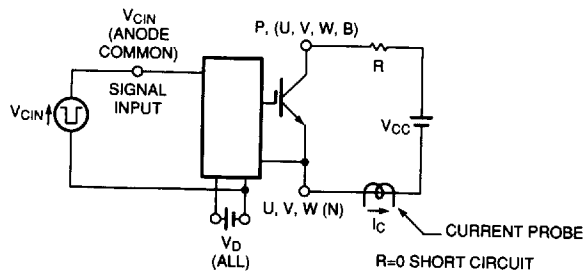

Figure 7 Over Current and Short Circuit Test