

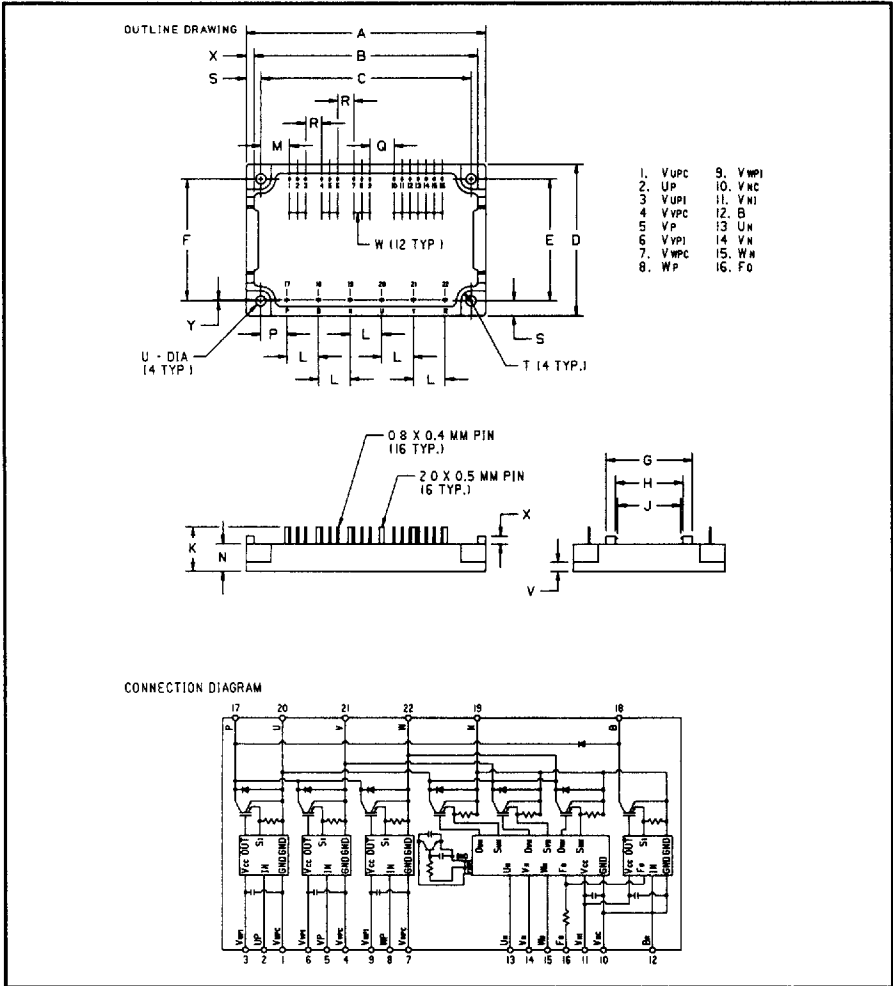

Powerex, Inc., Hillis Street, Youngwood, Pennsylvania 15697 (412) 925-7272
 Powerex, Europe, S.A. 428 Avenue G. Durand, BP107, 72003 Le Mans, France (43) 41.14.14

Intellimod™-3 Modules
Three Phase + Brake
IGBT Inverter Output
30 Amperes/110-230 Volt Line



Description

Powerex Intellimod-3 Modules are designed for applications requiring a high frequency (20kHz) output switching inverter. The modules are isolated from the baseplate, consisting of complete drive, control and protection circuitry for the IGBT inverter.

Features:

- Complete Output Power Circuit
- Gate Drive Circuit
- Protection Logic
 - Short Circuit
 - Over-Current
 - Over Temperature
 - Under Voltage

Applications:

- Inverters
- Small UPS
- Motion/Servo Control
- AC Motor Control

Ordering Information
 PM30RHC060

110-230 Volt Line, PM30RHC060 Outline Drawing

Dimensions	Inches	Millimeters
A	4.17±0.04	106.0±1.0
B	3.9	99.0
C	3.66±0.02	93.0±0.5
D	2.64±0.04	67.0±1.0
E	2.12±0.02	54.0±0.5
F	2.11±0.02	53.5±0.5
G	1.5	38.0
H	1.18	30.0
J	1.1	28.0
K	0.77±0.04	19.5±1.0
L	0.55±0.01	14.0±0.25
M	0.5	12.7

Dimensions	Inches	Millimeters
N	0.47	12.0
P	0.45	11.5
Q	0.42	10.68
R	0.28	7.12
S	0.26	6.5
T	0.18 R	4.5 R
U	0.18 Dia.	4.5 Dia.
V	0.16±0.02	4.0±0.5
W	0.14	3.56
X	0.14	3.5
Y	0.02	0.5



POWEREX INC

SLE D ■ 7294621 0005667 073 ■ PRX

Powerex, Inc., Hillis Street, Youngwood, Pennsylvania 15697 (412) 925-7272
 Powerex, Europe, S.A. 428 Avenue G. Durand, BP107, 72003 Le Mans, France (43) 41.14.14

PM30RHC060
Intellimod-3 Modules
Three Phase + Brake IGBT Inverter Output
 30 Amperes/110-230 Volt Line

T-57-29

Absolute Maximum Ratings, $T_j = 25\text{ }^\circ\text{C}$ unless otherwise specified

Characteristics	Symbol	PM30RHC060	Units
Power Device Junction Temperature	T_j	-20 to +150	$^\circ\text{C}$
Storage Temperature	T_{STG}	-40 to +125	$^\circ\text{C}$
Case Operating Temperature	T_C	-20 to +100	$^\circ\text{C}$
Mounting Torque, M4 Mounting Screws	—	12	Kg-cm
Module Weight (Typical)	—	140	Grams
Supply Voltage Protected by OC and SC ($V_D = 13.5 - 16.5\text{V}$, Inverter Part)	$V_{CC(prot)}$	400	Volts
Isolation Voltage AC 1 minute, 60Hz	V_{RMS}	2500	Volts

Control Sector

Supply Voltage Applied between ($V_{UP1} - V_{UPC}, V_{VP1} - V_{VPC}, V_{WP1} - V_{WPC}, V_{N1} - V_{NC}$)	V_D	20	Volts
Input Current Applied between ($U_P, V_P, U_N, V_N, W_N, B_r$)	I_{CIN}	20	mA
Input Voltage Applied between ($U_P, V_P, U_N, V_N, W_N, B_r$)	V_{CIN}	20	Volts
Fault Output Supply Voltage	V_{FO}	20	Volts
Fault Output Current	I_{FO}	20	mA

IGBT Inverter Sector

Collector-Emitter Voltage Fig. 1	V_{CES}	600	Volts
Collector Current \pm	I_C	30	Amperes
Peak Collector Current \pm	I_{CP}	60	Amperes
Supply Voltage (Applied between P - N)	V_{CC}	400	Volts
Supply Voltage (Surge) Applied between P - N	$V_{CC(surge)}$	500	Volts
Collector Dissipation	P_C	96	Watts

Brake Sector

Collector-Emitter Voltage Fig. 1	V_{CES}	600	Volts
Collector Current \pm	I_C	10	Amperes
Peak Collector Current \pm	I_{CP}	20	Amperes
Supply Voltage (Applied between P - N)	V_{CC}	400	Volts
Supply Voltage (Surge) Applied between P - N	$V_{CC(surge)}$	500	Volts
Collector Dissipation	P_C	41	Watts
Diode Forward Current	I_F	10	Amperes
Diode DC Reverse Voltage	$V_{R(DC)}$	600	Volts



POWEREX INC

51E D ■ 7294621 0005668 TOT ■ PRX

Powerex, Inc., Hillis Street, Youngwood, Pennsylvania 15697 (412) 925-7272
 Powerex, Europe, S.A. 428 Avenue G. Durand, BP107, 72003 Le Mans, France (43) 41.14.14

T-57-29

PM30RHC060
Intellimod-3 Modules
Three Phase + Brake IGBT Inverter Output
 30 Amperes/110-230 Volt Line

Electrical Characteristics, $T_j = 25^\circ\text{C}$ unless otherwise specified

Characteristics	Symbol	Test Conditions	Min.	Typ.	Max.	Units
Control Sector						
Overcurrent Trip Level Inverter Part	OC	$-20^\circ\text{C} \leq T \leq 125^\circ\text{C}$, $V_D = 15\text{V}$	39	53	–	Amperes
Overcurrent Trip Level Brake Part			12	18	–	Amperes
Short Circuit Trip Level Inverter Part	SC	$-20^\circ\text{C} \leq T \leq 125^\circ\text{C}$, $V_D = 15\text{V}$	–	80	–	Amperes
Short Circuit Trip Level Brake Part			–	27	–	Amperes
Over Current Delay Time	$t_{\text{off(OC)}}$	$V_D = 15\text{V}$, Fig. 7	–	10	–	μS
Over Temperature Protection	OT	Trip Level	100	110	120	$^\circ\text{C}$
Over Temperature Protection	OT_R	Reset Level	–	90	–	$^\circ\text{C}$
Supply Circuit Under Voltage Protection	UV	Trip Level	11.5	12.0	12.5	Volts
Supply Circuit Under Voltage Protection	UV_R	Reset Level	–	12.5	–	Volts
Supply Voltage	V_D	Applied between $V_{\text{UP1}} - V_{\text{UPC}}$, $V_{\text{VP1}} - V_{\text{VPC}}$, $V_{\text{WP1}} - V_{\text{WPC}}$, $V_{\text{N1}} - V_{\text{NC}}$	13.5	15	16.5	Volts
Circuit Current	I_D	$V_D = 15\text{V}$, $I_{\text{CIN}} = 1\text{mA}$, $V_{\text{N1}} - V_{\text{NC}}$	–	41	63	mA
	I_D	$V_D = 15\text{V}$, $I_{\text{CIN}} = 1\text{mA}$, $V_{\text{XP1}} - V_{\text{XPC}}$	–	7	12	mA
Input Bias On Current	$I_{\text{CIN(on)}}$	Sink Current at $U_P, V_P, W_P, U_N, V_N, W_N$	0.1	0.22	0.5	mA
Input Bias Off Current	$I_{\text{CIN(off)}}$	Sink Current at $U_P, V_P, W_P, U_N, V_N, W_N$	0.1	0.22	0.5	mA
Input On Voltage	$V_{\text{CIN(on)}}$	Applied between $B_r - V_{\text{NC}}$	1.2	1.5	1.8	Volts
Input Off Voltage	$V_{\text{CIN(off)}}$	Applied between $B_r - V_{\text{NC}}$	1.7	2.0	2.3	Volts
PWM Input Frequency	f_{PWM}	3- \emptyset Sinusoidal	–	15	20	kHz
Dead Time	t_{DEAD}	For each Input Pulse	2.9	–	–	μS
		Using example Interface Circuit*	5.4	–	–	μS
Fault Output Current	$I_{\text{FO(H)}}$	$V_D = 15\text{V}$, $V_{\text{FO}} = 15\text{V}$	–	–	0.01	mA
	$I_{\text{FO(L)}}$	$V_D = 15\text{V}$, $V_{\text{FO}} = 15\text{V}$	–	10	15	ma
Minimum Fault Output Pulse Width	t_{FO}	$V_D = 15\text{V}$	20	40	60	μS
		Using example Interface Circuit*	25	100	–	μS
		$V_D = 15\text{V}$				
Brake Sector						
Collector Emitter Saturation Voltage	$V_{\text{CE(sat)}}$	$V_D = 15\text{V}$, $V_{\text{CIN}} = 0\text{V}$, $I_C = 10\text{A}$, $T_j = 25^\circ\text{C}$, Fig. 2	–	2.6	3.5	Volts
		$V_D = 15\text{V}$, $V_{\text{CIN}} = 0\text{V}$, $I_C = 10\text{A}$, $T_j = 125^\circ\text{C}$, Fig. 2	–	2.9	4.0	Volts
Diode Forward Voltage	V_{FM}	$-I_C = 10\text{A}$, $V_D = 15\text{V}$, $V_{\text{CIN}} = 15\text{V}$, Fig. 3	–	1.6	2.2	Volts
Collector Cutoff Current	I_{CEX}	$V_{\text{CE}} = V_{\text{CES}}$, $T_j = 25^\circ\text{C}$, Fig. 6	–	–	1	mA
		$V_{\text{CE}} = V_{\text{CES}}$, $T_j = 125^\circ\text{C}$, Fig. 6	–	–	10	mA

*See Intellimod-3 Applications Data Section 4.3.



POWEREX INC

51E D ■ 7294621 0005669 946 ■ PRX

Powerex, Inc., Hillis Street, Youngwood, Pennsylvania 15697 (412) 925-7272
 Powerex, Europe, S.A. 428 Avenue G. Durand, BP107, 72003 Le Mans, France (43) 41.14.14

T-57-29

PM30RHC060
Intellimod-3 Modules
Three Phase + Brake IGBT Inverter Output
 30 Amperes/110-230 Volt Line

Electrical Characteristics, $T_J = 25^\circ\text{C}$ unless otherwise specified

Characteristics	Symbol	Test Conditions	Min.	Typ.	Max.	Units
IGBT Inverter Sector						
Collector Cutoff Current	I_{CEX}	$V_{CE} = V_{CES}, T_J = 25^\circ\text{C}, \text{Fig. 6}$	-	-	1	mA
Collector Cutoff Current	I_{CEX}	$V_{CE} = V_{CES}, T_J = 125^\circ\text{C}, \text{Fig. 6}$	-	-	10	mA
Diode Forward Voltage	V_{FM}	$-I_C = 30\text{A}, V_D = 15\text{V}, I_{CIN} = 1\text{mA}, \text{Fig. 3}$	-	1.7	2.5	Volts
Collector Emitter Saturation Voltage	$V_{CE(sat)}$	$V_D = 15\text{V}, I_{CIN} = 0\text{mA}, I_C = 20\text{A}, \text{Fig. 2}$	-	2.7	3.5	Volts
Collector Emitter Saturation Voltage	$V_{CE(sat)}$	$V_D = 15\text{V}, I_{CIN} = 0\text{mA}, I_C = 30\text{A}, \text{Fig. 2}$	-	2.5	3.4	Volts
Inductive Load Switching Times	t_{on}	$V_D = 15\text{V}, I_{CIN} = 0\text{mA},$	0.5	0.8	1.5	μS
	t_{tr}	$V_{CC} = 300\text{V}, I_C = 20\text{A},$	-	0.15	0.4	μS
	$t_{C(on)}$	$T_J = 125^\circ\text{C}$	-	0.4	1.2	μS
	t_{off}	Fig. 4, 5	-	2.0	3.4	μS
	$t_{C(off)}$		-	0.6	1.2	μS

Thermal Characteristics

Characteristics	Symbol	Test Conditions	Min.	Typ.	Max.	Units
Thermal Resistances Junction to Case	$R_{th(I-C)Q}$	Inverter IGBT	-	-	1.3	$^\circ\text{C/W}$
	$R_{th(I-C)F}$	Inverter FWD	-	-	3.0	$^\circ\text{C/W}$
	$R_{th(I-C)Q}$	Brake IGBT	-	-	3.0	$^\circ\text{C/W}$
	$R_{th(I-C)F}$	Brake FWD	-	-	4.5	$^\circ\text{C/W}$
Contact Thermal Resistance	$R_{th(C-F)}$	Case to Fin, Thermal Grease Applied	-	-	0.3	$^\circ\text{C/W}$

Recommended Operating Conditions

Characteristics	Symbol	Test Conditions	Value	Units
Supply Voltage	V_{CC}	Applied across P - N Terminals	0 ~ 400	Volts
	V_D	Applied between $V_{UP1} - V_{UPC},$ $V_{N1} - V_{NC}, V_{VP1} - V_{VPC}, V_{WP1} - V_{WPC}$	15 ± 1.5	Volts
Input On Current	$V_{CIN(on)}$	Applied between	0 ~ 0.5	Volts
Input Off Current	$V_{CIN(off)}$	$U_P, V_P, W_P, U_N, V_N, W_N$	0.5 ~ 2	Volts
Input On Voltage	$V_{CIN(on)}$	Applied between	0 ~ 0.8	Volts
Input Off Voltage	$V_{CIN(off)}$	$B_T - V_{NC}$	4.0 ~ 15	Volts
PWM Input Frequency	f_{PWM}	Using example Interface Circuit *	5 ~ 20	kHz
Minimum Dead Time	t_{DEAD}	Using example Interface Circuit *	5.4	μS

*See Intellimod-3 Applications Data Section 4.3.

T-57-29

PM30RHC060

Intellimod-3 Modules

Three Phase + Brake IGBT Inverter Output

30 Amperes/110-230 Volt Line

Inverter Part

SATURATION VOLTAGE CHARACTERISTICS (TYPICAL)

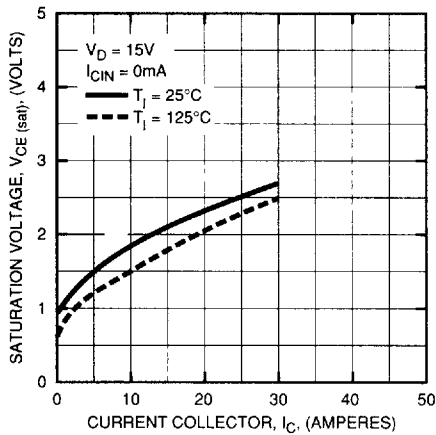

COLLECTOR-EMITTER SATURATION VOLTAGE (TYPICAL)

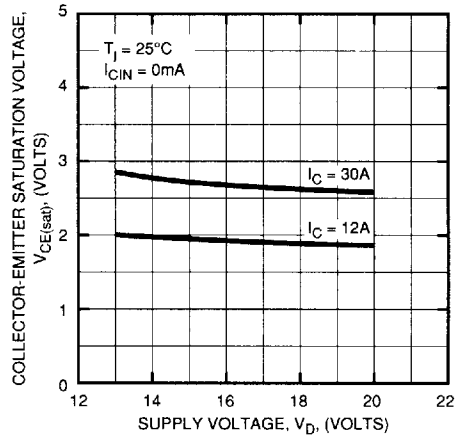

OUTPUT CHARACTERISTICS (TYPICAL)

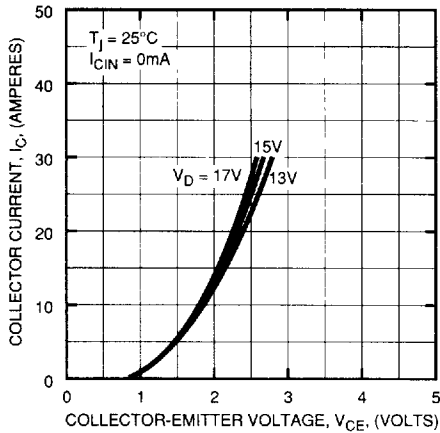

SWITCHING TIME VS. COLLECTOR CURRENT (TYPICAL)

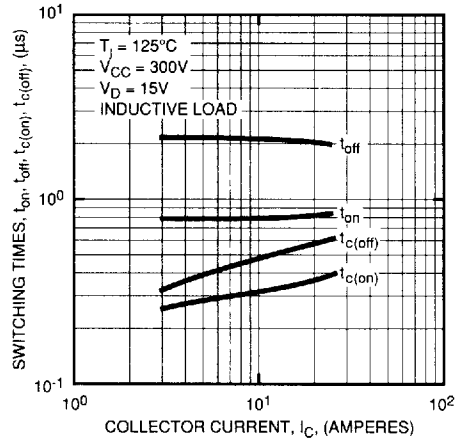

REVERSE RECOVERY CHARACTERISTICS OF FREE-WHEEL DIODE (TYPICAL)

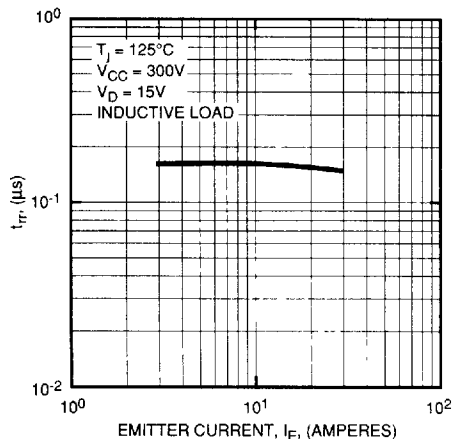

REVERSE COLLECTOR CURRENT VS. EMITTER-COLLECTOR VOLTAGE (DIODE FORWARD CHARACTERISTICS) (TYPICAL)

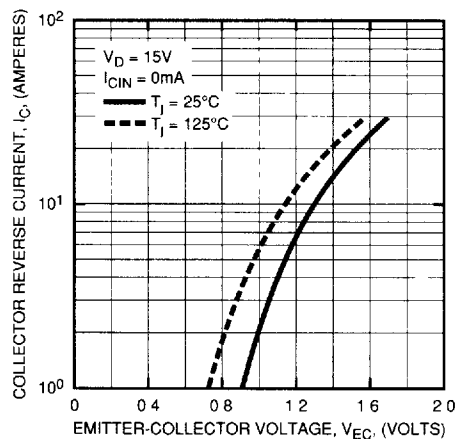

Powerex, Inc., Hillis Street, Youngwood, Pennsylvania 15697 (412) 925-7272
 Powerex, Europe, S.A. 428 Avenue G. Durand, BP107, 72003 Le Mans, France (43) 41.14.14

PM30RHC060
Intellimod-3 Modules
Three Phase + Brake IGBT Inverter Output
 30 Amperes/110-230 Volt Line
 Inverter Part

T-57-29

**POWER DISSIPATION DERATING CURVE
 (PER IGBT ELEMENT)**

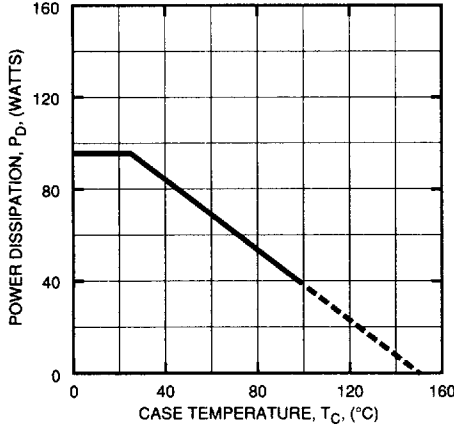

**POWER DISSIPATION DERATING CURVE
 (PER FWDI ELEMENT)**

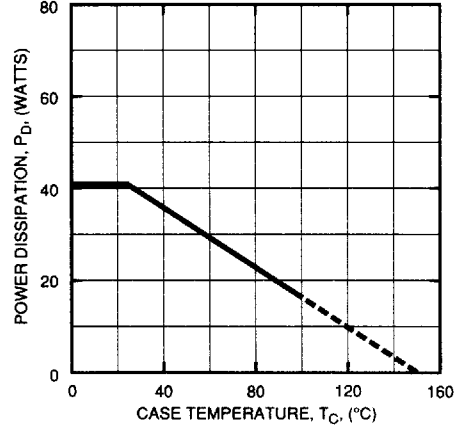

**TRANSIENT THERMAL
 IMPEDANCE CHARACTERISTICS
 (IGBT)**

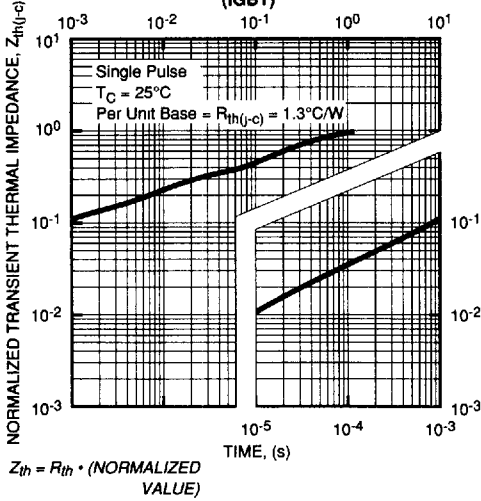

**TRANSIENT THERMAL
 IMPEDANCE CHARACTERISTICS
 (FWDI)**

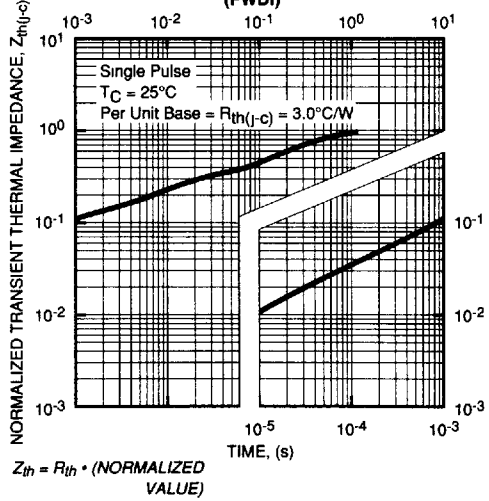



POWEREX INC

51E D ■ 7294621 0005672 430 ■ PRX

Powerex, Inc., Hillis Street, Youngwood, Pennsylvania 15697 (412) 925-7272
Powerex, Europe, S.A. 428 Avenue G. Durand, BP107, 72003 Le Mans, France (43) 41.14.14

PM30RHC060
Intellimod-3 Modules
Three Phase + Brake IGBT Inverter Output
30 Amperes/110-230 Volt Line
Brake Part

T-57-29

SATURATION VOLTAGE CHARACTERISTICS (TYPICAL)

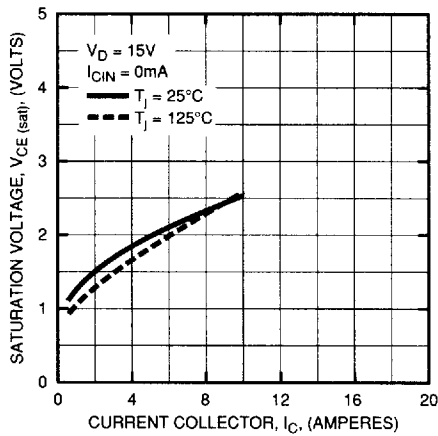

COLLECTOR-EMITTER SATURATION VOLTAGE (TYPICAL)

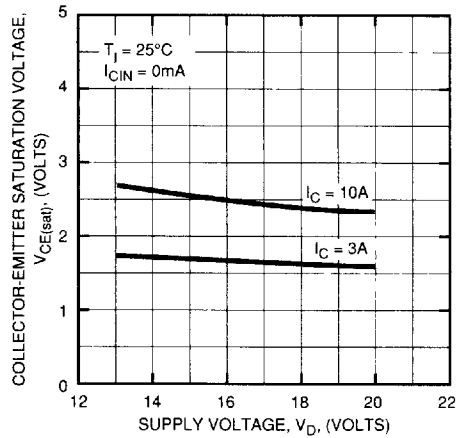

OUTPUT CHARACTERISTICS (TYPICAL)

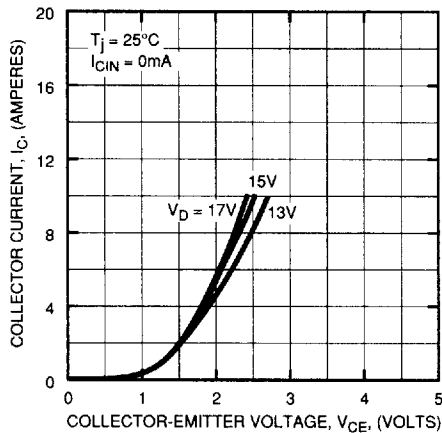

REVERSE COLLECTOR CURRENT VS. EMITTER-COLLECTOR VOLTAGE (DIODE FORWARD CHARACTERISTICS) (TYPICAL)

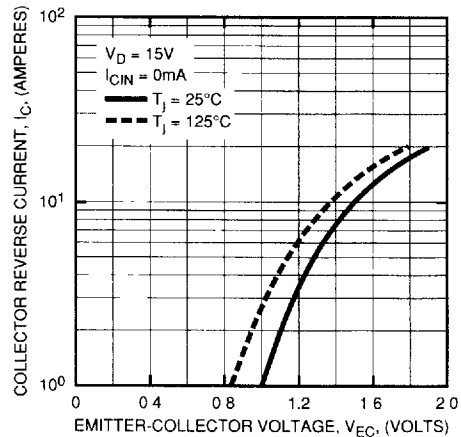



POWEREX INC

51E D ■ 7294621 0005673 377 ■ PRX

Powerex, Inc., Hillis Street, Youngwood, Pennsylvania 15697 (412) 925-7272
 Powerex, Europe, S.A. 428 Avenue G. Durand, BP107, 72003 Le Mans, France (43) 41.14.14

T-57-29

PM30RHC060
Intellimod-3 Modules
Three Phase + Brake IGBT Inverter Output
30 Amperes/110-230 Volt Line
Brake Part

POWER DISSIPATION DERATING CURVE
 (PER IGBT ELEMENT)

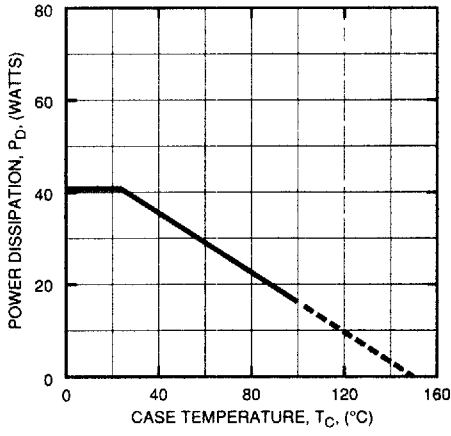

POWER DISSIPATION DERATING CURVE
 (PER FWDI ELEMENT)

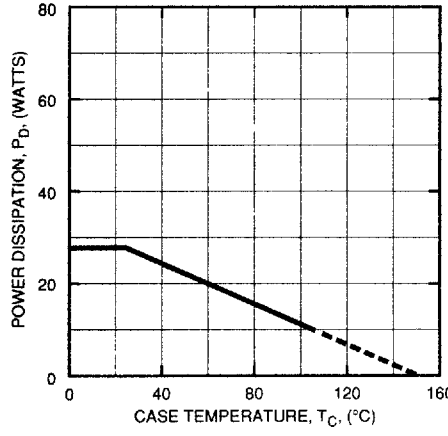

TRANSIENT THERMAL IMPEDANCE CHARACTERISTICS
 (IGBT)

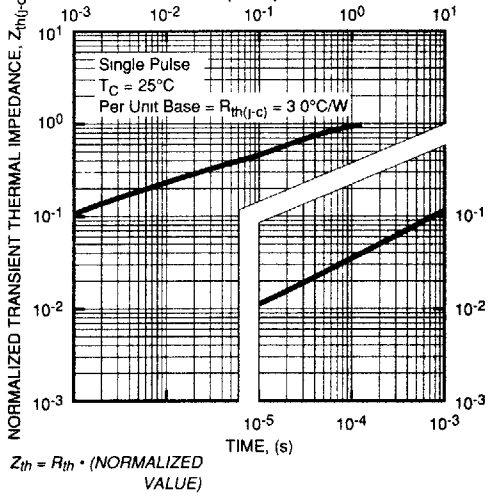

TRANSIENT THERMAL IMPEDANCE CHARACTERISTICS
 (FWDI)

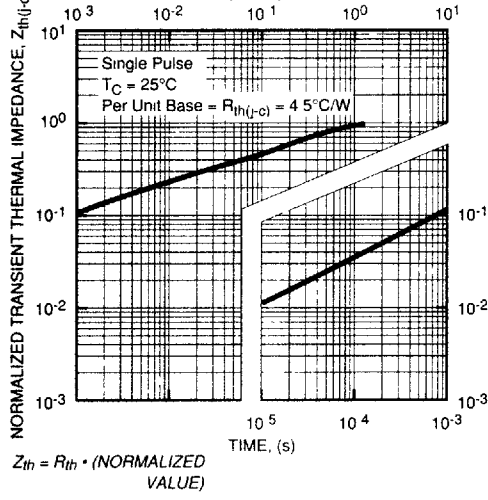

PM30RHC060
Intellimod-3 Modules
Three Phase + Brake IGBT Inverter Output
 30 Amperes/110-230 Volt Line

T-57-29

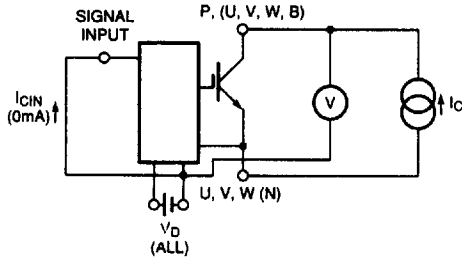

Figure 1 V_{CES} Test

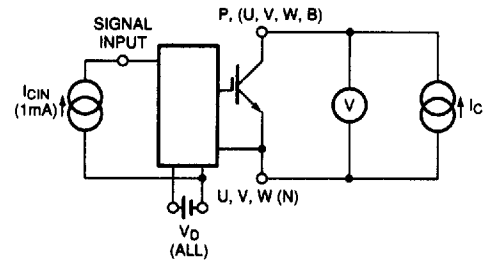

Figure 2 $V_{CE(SAT)}$ Test

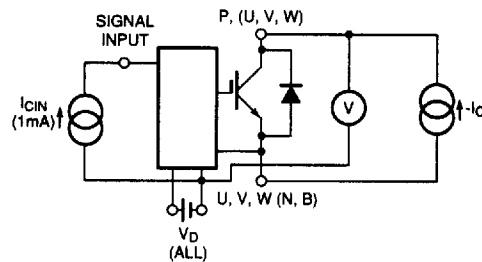
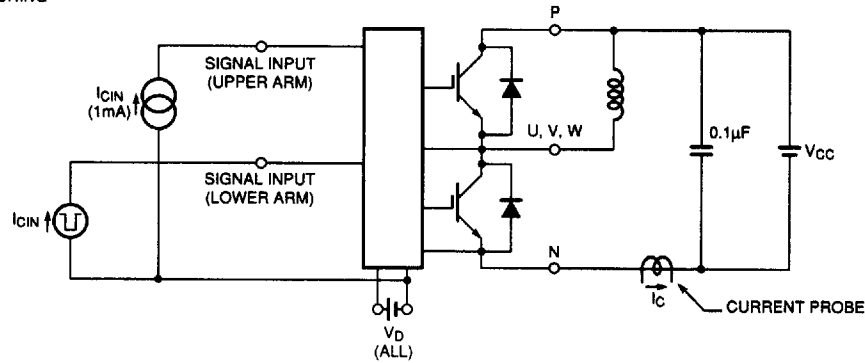

Figure 3 V_{EC} Test

A) LOWER ARM SWITCHING



B) UPPER ARM SWITCHING

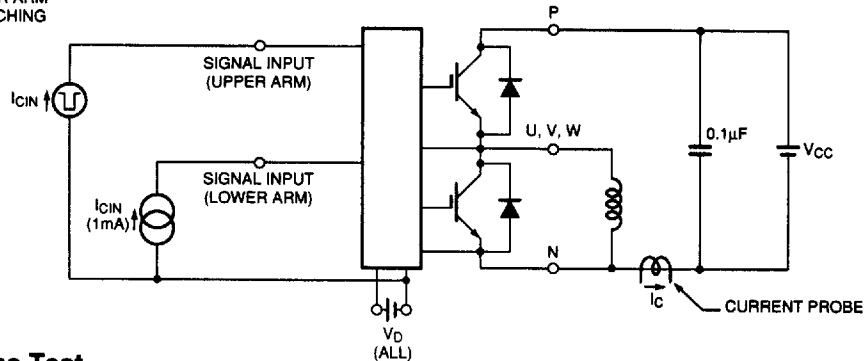

Figure 4 Switching Time Test

T-57-29

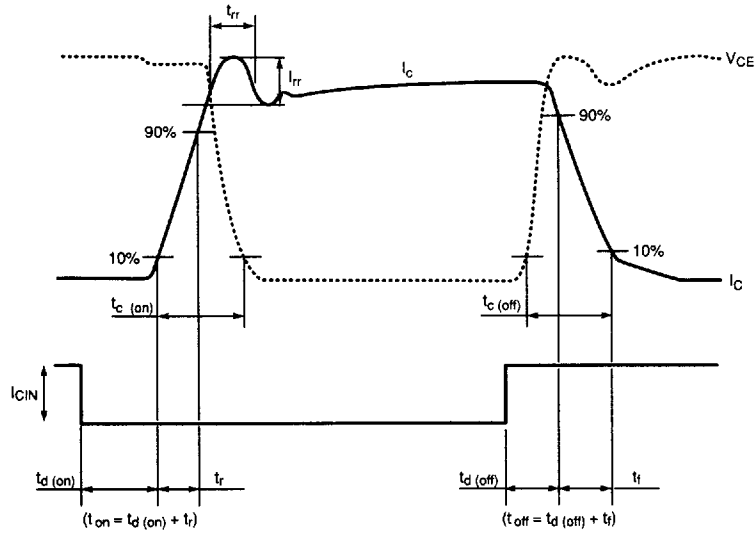

Figure 5 Switching Test Waveform

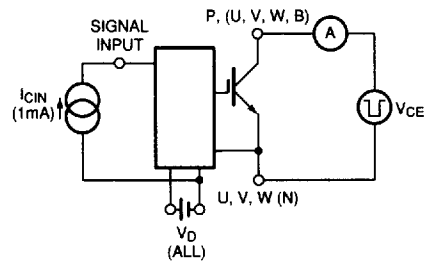

Figure 6 I_{CES} Test

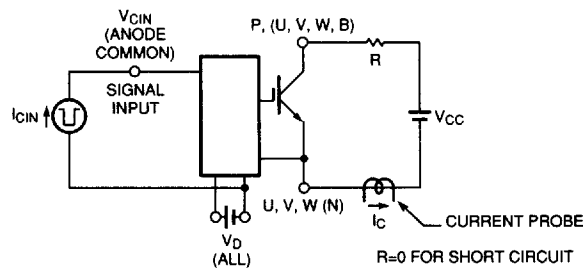

Figure 7 Over Current and Short Circuit Test