

PM15CTM060-3

FLAT-BASE TYPE
INSULATED PACKAGE

PM15CTM060-3

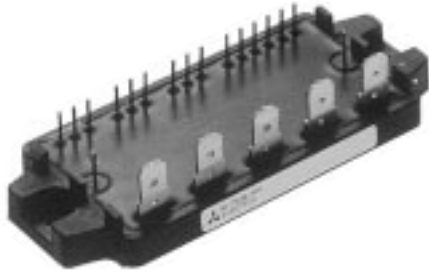

- 600V, 15A Current-sense 6kHz IGBT type inverter
- Built in IGBT gate drive circuit
- Built in Fault OC, SC, OT & UV protection Fault output
- 0.75kW class inverter application
- UL Recognized

Yellow Card No. E80276 (N)
File No. E80271

APPLICATION

Air conditioner, motor control

OUTLINE DRAWING

Dimensions in mm

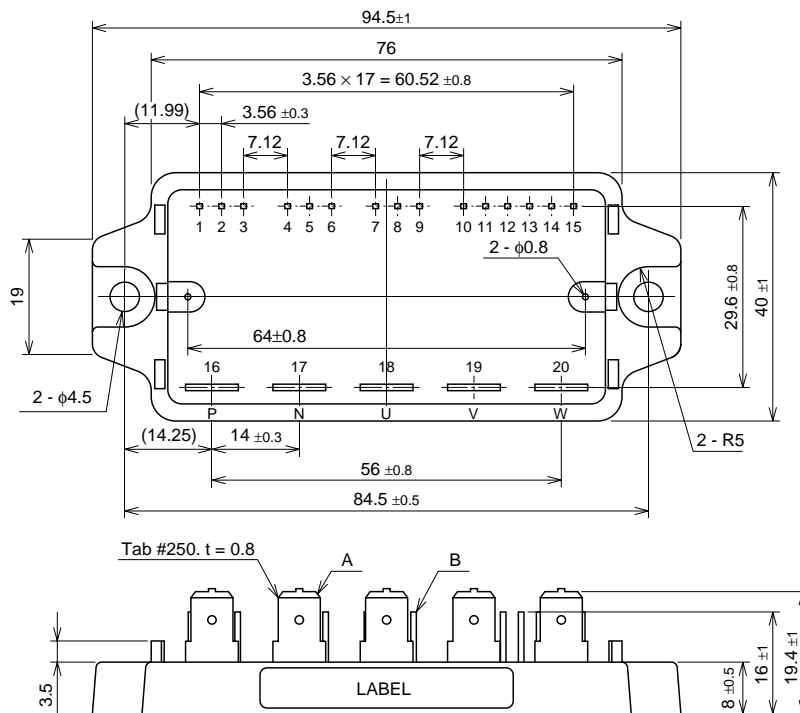

A - B: TERMINAL NAME

1.	VUPC	11.	VN1
2.	UP	12.	UN
3.	VUP1	13.	VN
4.	VVPC	14.	WN
5.	VP	15.	FO
6.	VVP1	16.	P
7.	VWPC	17.	N
8.	WP	18.	U
9.	VWP1	19.	V
10.	VNC	20.	W

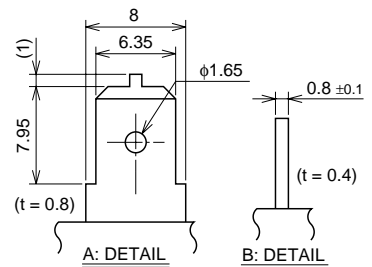
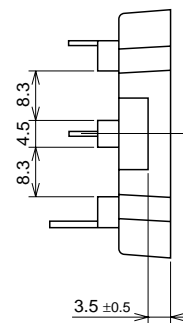

PM15CTM060-3

FLAT-BASE TYPE
INSULATED PACKAGE

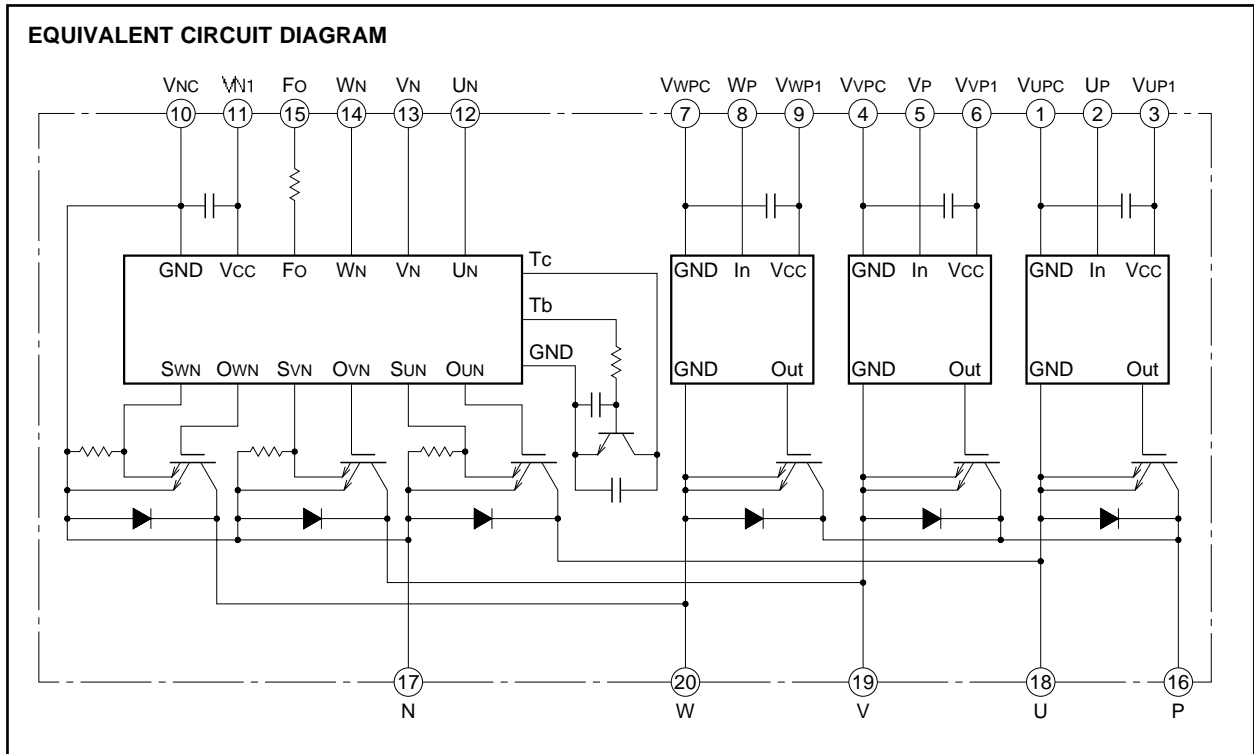

MAXIMUM RATINGS ($T_j = 25^\circ\text{C}$, unless otherwise noted)

INVERTER PART

Symbol	Parameter	Conditions	Ratings	Unit
V_{CES}	Collector-emitter voltage	$V_D = 15\text{V}$, $I_{CIN} = 10\text{mA}$	600	V
$\pm I_C$	Collector current	$T_C = 25^\circ\text{C}$	15	A
$\pm I_{CP}$	Collector current (peak)	$T_C = 25^\circ\text{C}$	30	A
P_C	Collector dissipation	$T_C = 25^\circ\text{C}$	43	W
T_j	Junction temperature		$-20 \sim +125^*$	$^\circ\text{C}$

* maximum instantaneous $T_j \leq 150^\circ\text{C}$

CONTROL PART

Symbol	Parameter	Conditions	Ratings	Unit
V_D	Supply voltage	Applied between : $V_{UP1}-V_{UPC}$, $V_{VP1}-V_{VPC}$ $V_{WP1}-V_{WPC}$, $V_{N1}-V_{NC}$	20	V
I_{CIN}	Input current	Applied between : U_P-V_{UPC} , V_P-V_{VPC} , W_P-V_{WPC} , $U_N \cdot V_N \cdot W_N-V_{NC}$	20	mA
V_{FO}	Fault output supply voltage	Applied between : F_O-V_{NC}	20	V
I_{FO}	Fault output current	Sink current of F_O terminal	20	mA

PM15CTM060-3

FLAT-BASE TYPE
INSULATED PACKAGE

TOTAL SYSTEM

Symbol	Parameter	Conditions	Ratings	Unit
VCC(PROT)	Supply voltage protected by OC & SC	V _D = 13.5 ~ 16.5V, Inverter part, T _j = 125°C start	400	V
VCC	Supply voltage	Applied between : P-N, operating time	450	V
VCC(surge)	Supply voltage (surge)	Applied between : P-N, surge and non-operating time	500	V
T _C	Module case operating temperature	(Note 1)	-20 ~ +100	°C
T _{stg}	Storage temperature		-40 ~ +125	°C
V _{iso}	Isolation voltage	60Hz, sinusoidal, AC · 1 min	2500	V _{rms}

Note 1 : T_C measuring point is as shown below.

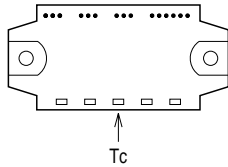

ELECTRICAL CHARACTERISTICS (T_j = 25°C, unless otherwise noted)

INVERTER PART

Symbol	Parameter	Test conditions	Limits			Unit	
			Min.	Typ.	Max.		
V _{CE(sat)}	Collector-emitter saturation voltage	V _D = 15V, I _{CIN} = 10mA	I _C = 15A, T _j = 25°C	—	1.8	2.6	V
			I _C = 15A, T _j = 125°C	—	2.0	3.0	
V _{EC}	FWDi forward voltage	-I _C = 15A, V _D = 15V, I _{CIN} = 0mA	—	2.0	3.0	V	
t _{on}	Switching time	V _D = 15V, I _{CIN} = 0mA↔10mA V _{CC} = 300V, I _C = 15A T _j = 125°C (Per 1 arm) Inductive Load	0.5	1.0	2.0	μs	
t _{rr}			—	0.1	—	μs	
t _{c(on)}			—	0.2	0.8	μs	
t _{off}			—	2.5	3.5	μs	
t _{c(off)}			—	0.9	2.0	μs	
I _{CES}	Collector-emitter cutoff current	V _{CE} = V _{CEs} , I _{CIN} = 0mA	T _j = 25°C	—	—	1	mA
			T _j = 125°C	—	—	10	

CONTROL PART

Symbol	Parameter	Test conditions	Limits			Unit	
			Min.	Typ.	Max.		
I _D	Circuit current	V _D = 15V, I _{CIN} = 0mA	V _{N1} -V _{Nc}	—	25	35	mA
			V _{XP1} -V _{XPC}	—	5	10	
I _{th(ON)}	Input on threshold current	Applied between : UP-VU _{PC} , VP-VV _{PC} , WP-VW _{PC}	1	3	5	mA	
I _{th(OFF)}	Input off threshold current	UN · V _N · WN-V _{Nc}	1	3	5	mA	
OC	Over current trip level	-20°C ≤ T _j ≤ 125°C, V _D = 15V (only N side)	18	23	—	A	
SC	Short circuit trip level	-20°C ≤ T _j ≤ 125°C, V _D = 15V (only N side)	—	34.5	—	A	
t _{off(OC)}	Over current delay time	V _D = 15V	—	10	—	μs	
OT	Over temperature protection	Base-plate	Trip level	100	110	120	°C
		Temperature detection, V _D = 15V	Reset level	—	90	—	°C
UV	Supply circuit under voltage protection	-20°C ≤ T _j ≤ 125°C (only N side)	Trip level	11.5	12.0	12.5	V
			Reset level	—	12.5	—	V
I _{FO(H)}	Fault output current (Note 2)	V _D = 15V, V _{FO} = 15V	—	—	0.01	mA	
I _{FO(L)}			—	10	15	mA	
t _{FO}	Minimum fault output pulse width (Note 2)	V _D = 15V	1.0	1.8	—	ms	

* PWN control input frequency is restricted by radiation condition

Note 2 : Fault output is given only when the internal OC, SC, OT & UV protection. (only N side)

Fault output of OC, SC protection given pulse.

Fault output of OT, UV protection given pulse while over level. (OT is only N side)

PM15CTM060-3

FLAT-BASE TYPE
INSULATED PACKAGE

THERMAL RESISTANCES

Symbol	Parameter	Test conditions	Limits			Unit
			Min.	Typ.	Max.	
R _{th(j-c)Q}	Junction to case thermal resistances	Inverter IGBT part, per 1/6 module	—	—	2.9	°C / W
R _{th(j-c)F}		Inverter FWDi part, per 1/6 module	—	—	4.5	°C / W
R _{th(c-f)}	Contact thermal resistance	Case to fin, thermal grease applied, per 1/6 module	—	—	0.4	°C / W

MECHANICAL RATINGS AND CHARACTERISTICS

Symbol	Parameter	Test conditions	Limits			Unit
			Min.	Typ.	Max.	
—	Mounting torque	Mounting screw : M4	0.98	1.18	1.47	N·m
—	Weight		10	12	15	kg·cm
—	Weight		—	60	—	g

RECOMMENDED CONDITIONS FOR USE

Symbol	Parameter	Test conditions	Ratings	Unit
V _{CC}	Supply voltage	Applied between : P-N	≤ 400	V
V _D		Applied between : V _{UP1} -V _{UPC} , V _{VP1} -V _{VPC} V _{WP1} -V _{WPC} , V _{UN1} -V _{UNC} (Note 3)	15 ± 1.5	V
I _{CIN(ON)}	Input on current	Applied between : UP, VP, WP, UN, VN, WN	≥ 5	mA
I _{CIN(OFF)}	Input off current		≤ 1	mA
f _{PWM}	PWM input frequency	Using application circuit Opto-coupler's input signal	≤ 8	kHz
t _{dead}	Arm shoot-through blocking time	Using application circuit Opto-coupler's input signal	≥ 3	μs

Note 3 : Permissible ripple value : dv/dt ≤ ±5V/μs, V_{ripple} ≤ 2V_{P-P}

PM15CTM060-3

FLAT-BASE TYPE
INSULATED PACKAGE

PERFORMANCE CURVES

OUTPUT CHARACTERISTICS (TYPICAL)

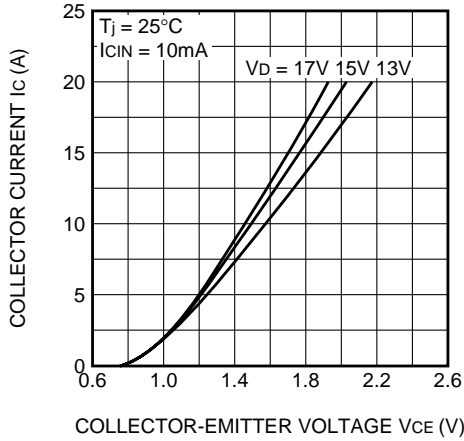

COLLECTOR-EMITTER SATURATION VOLTAGE CHARACTERISTICS (TYPICAL)

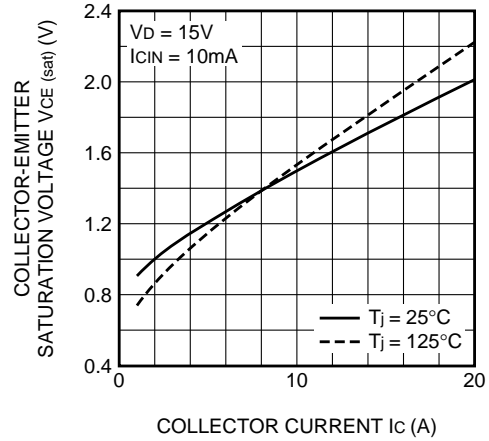

COLLECTOR-EMITTER SATURATION VOLTAGE VS. SUPPLY VOLTAGE (TYPICAL)

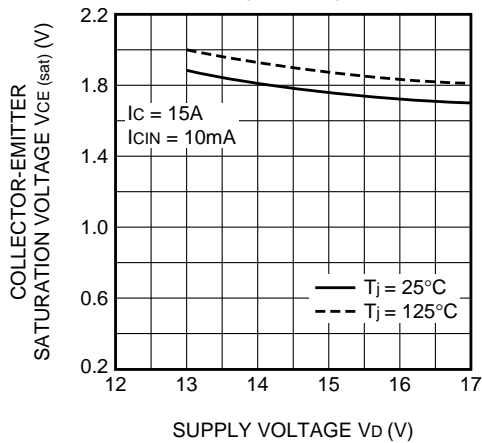

SWITCHING TIME VS. COLLECTOR CURRENT (TYPICAL)

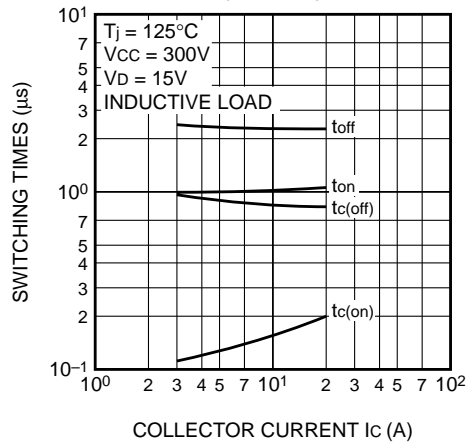

FREE-WHEEL DIODE FORWARD CHARACTERISTICS (TYPICAL)

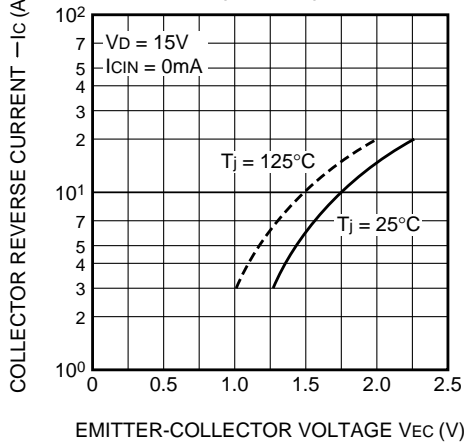

REVERSE RECOVERY CHARACTERISTICS OF FREE-WHEEL DIODE (TYPICAL)

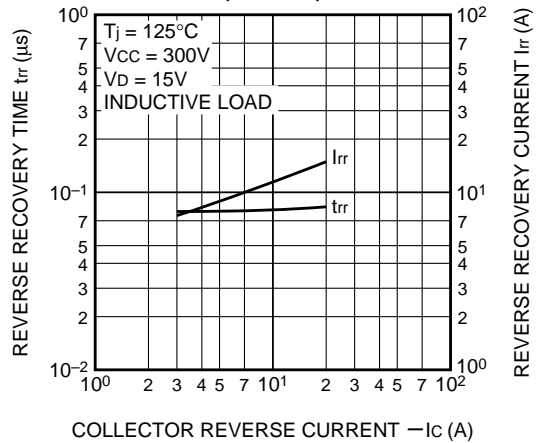

PM15CTM060-3

FLAT-BASE TYPE
INSULATED PACKAGE

