

Powerex, Inc., Hillis Street, Youngwood, Pennsylvania 15697 (412) 925-7272
 Powerex, Europe, S.A. 428 Avenue G. Durand, BP107, 72003 Le Mans, France (43) 41.14.14

Intellimod™-3 Modules
 Three Phase
 IGBT Inverter Output
 10 Amperes/110-230 Volt Line

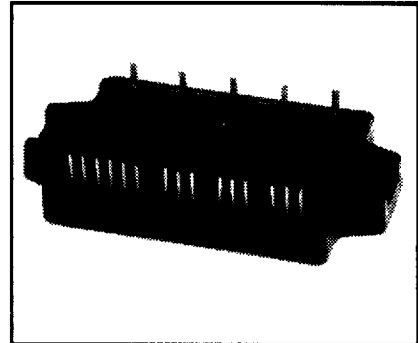
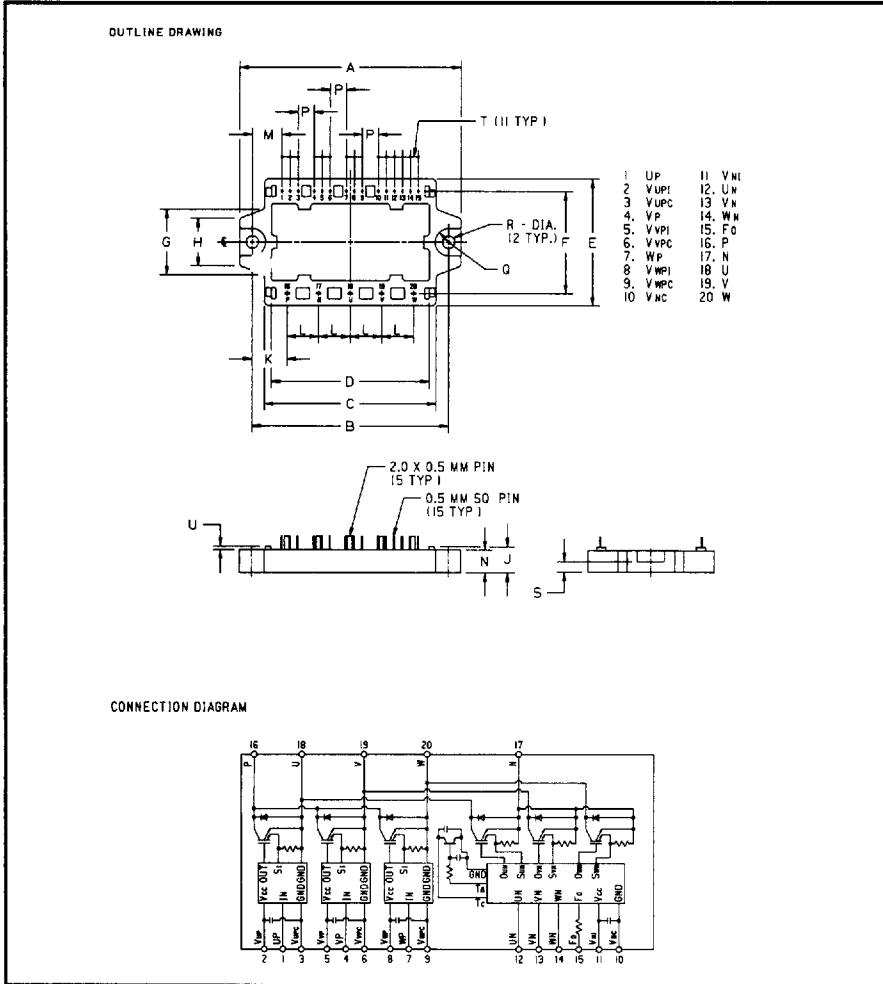

Description

Powerex Intellimod-3 Modules are designed for applications requiring a high frequency (20kHz) output switching inverter. The modules are isolated from the baseplate, consisting of complete drive, control and protection circuitry for the IGBT inverter.

Features:

- Complete Output Power Circuit
- Gate Drive Circuit
- Protection Logic
 - Short Circuit
 - Over-Current
 - Over Temperature
 - Under Voltage

Applications:

- Inverters
- Small UPS
- Motion/Servo Control
- AC Motor Control

Ordering Information
 PM10CHA060

110-230 Volt Line, PM10CHA060 Outline Drawing

Dimensions	Inches	Millimeters
A	3.86±0.04	98.0±1.0
B	3.42±0.02	87.0±0.5
C	2.99	76.0
D	2.76	70.0
E	2.20±0.04	56.0±1.0
F	1.77	45.0
G	1.14	29.0
H	0.83	21.0
J	0.63	16.0
K	0.61	15.5

Dimensions	Inches	Millimeters
L	0.55	14.0
M	0.521	13.24
N	0.39	10.0
P	0.28	7.12
Q	0.24R	6.0R
R	0.22 Dia.	5.5 Dia
S	0.20	5.0
T	0.14	3.56
U	0.06	1.5V



POWEREX INC

SIE D ■ 7294621 0005643 63T ■ PRX

Powerex, Inc., Hillis Street, Youngwood, Pennsylvania 15697 (412) 925-7272
Powerex, Europe, S.A. 428 Avenue G. Durand, BP107, 72003 Le Mans, France (43) 41.14.14

T-57-29

PM10CHA060
Intellimod-3 Modules
Three Phase IGBT Inverter Output
10 Amperes/110-230 Volt Line

Absolute Maximum Ratings, $T_j = 25\text{ }^\circ\text{C}$ unless otherwise specified

Characteristics	Symbol	PM10CHA060	Units
Power Device Junction Temperature	T_j	-20 to +150	$^\circ\text{C}$
Storage Temperature	T_{STG}	-40 to +125	$^\circ\text{C}$
Case Operating Temperature	T_C	-20 to +100	$^\circ\text{C}$
Mounting Torque, M5 Mounting Screws	—	17	Kg-cm
Module Weight (Typical)	—	90	Grams
Supply Voltage Protected by OC and SC ($V_D = 13.5 - 16.5\text{ V}$, Inverter Part)	$V_{CC (prot)}$	400	Volts
Isolation Voltage AC 1 minute, 60Hz	V_{RMS}	2500	Volts

Control Sector

Supply Voltage Applied between ($V_{UP1} - V_{UPC}, V_{VP1} - V_{VPC}, V_{WP1} - V_{WPC}, V_{N1} - V_{NC}$)	V_D	20	Volts
Input Current Applied between ($U_P, V_P, W_P, U_N, V_N, W_N$)	I_{CIN}	20	mA
Input Voltage Applied between ($U_P, V_P, W_P, U_N, V_N, W_N$)	V_{CIN}	20	Volts
Fault Output Supply Voltage	V_{FO}	20	Volts
Fault Output Current	I_{FO}	20	mA

IGBT Inverter Sector

Collector-Emitter Voltage Fig. 1	V_{CES}	600	Volts
Collector Current \pm	I_C	10	Amperes
Peak Collector Current \pm	I_{CP}	20	Amperes
Supply Voltage (Applied between P - N)	V_{CC}	400	Volts
Supply Voltage (Surge) Applied between P - N	$V_{CC (surge)}$	500	Volts
Collector Dissipation	P_C	39	Watts



POWEREX INC

51E D ■ 7294621 0005644 576 ■ PRX

Powerex, Inc., Hillis Street, Youngwood, Pennsylvania 15697 (412) 925-7272
 Powerex, Europe, S.A. 428 Avenue G. Durand, BP107, 72003 Le Mans, France (43) 41.14.14

T-57-29

PM10CHA060
 Intellimod-3 Modules
 Three Phase IGBT Inverter Output
 10 Amperes/110-230 Volt Line

Electrical Characteristics, $T_j = 25\text{ }^\circ\text{C}$ unless otherwise specified

Characteristics	Symbol	Test Conditions	Min.	Typ.	Max.	Units
Control Sector						
Overcurrent Trip Level Inverter Part	OC	$-20^\circ\text{C} \leq T \leq 125^\circ\text{C}$	12	18	–	Amperes
Short Circuit Trip Level Inverter Part	SC	$-20^\circ\text{C} \leq T \leq 125^\circ\text{C}$	–	27	–	Amperes
Overcurrent Delay Time	$t_{off(OC)}$	$V_D = 15\text{V}$ Fig. 7	–	10	–	μS
Over Temperature Protection	OT	Trip Level	100	110	120	$^\circ\text{C}$
Over Temperature Protection	OT_R	Reset Level	–	90	–	$^\circ\text{C}$
Supply Circuit Under Voltage Protection	UV	Trip Level	11.5	12.0	12.5	Volts
Supply Circuit Under Voltage Protection	UV_R	Reset Level	–	12.5	–	Volts
Supply Voltage	V_D	Applied between $V_{UP1} - V_{UPC}$, $V_{VP1} - V_{VPC}$, $V_{WP1} - V_{WPC}$, $V_{N1} - V_{NC}$	13.5	15	16.5	Volts
Circuit Current	I_D	$V_D = 15\text{V}$, $I_{CIN} = 1\text{mA}$, $V_{N1} - V_{NC}$	–	25	40	mA
	I_D	$V_D = 15\text{V}$, $I_{CIN} = 1\text{mA}$, $V_{XP1} - V_{XPC}$	–	7	12	mA
Input Bias On Current	$I_{CIN(on)}$	Sink Current at $U_P, V_P, W_P, U_N, V_N, W_N$	0.1	0.22	0.5	mA
Input Bias Off Current	$I_{CIN(off)}$	Sink current at $U_P, V_P, W_P, U_N, V_N, W_N$	0.1	0.22	0.5	mA
PWM Input Frequency	f_{PWM}	3- \emptyset Sinusoidal	–	15	20	kHz
Dead Time	t_{DEAD}	For each Input Pulse	2.0	–	–	μS
		Using example Interface Circuit*	5.0	–	–	μS
Fault Output Current	$I_{FO(H)}$	$V_D = 15\text{V}$, $V_{FO} = 15\text{V}$	–	–	0.01	mA
	$I_{FO(L)}$	$V_D = 15\text{V}$, $V_{FO} = 15\text{V}$	–	10	15	mA
Minimum Fault Output Pulse Width	t_{FO}	$V_D = 15\text{V}$	20	40	60	μS
		Using example Interface Circuit* $V_D = 15\text{V}$	25	100	–	μS

*See Intellimod-3 Applications Data Section 4.3.



POWEREX INC

51E D ■ 7294621 0005645 402 ■ PRX

Powerex, Inc., Hillis Street, Youngwood, Pennsylvania 15697 (412) 925-7272

Powerex, Europe, S.A. 428 Avenue G. Durand, BP107, 72003 Le Mans, France (43) 41.14.14

PM10CHA060

Intellimod-3 Modules

Three Phase IGBT Inverter Output

10 Amperes/110-230 Volt Line

T-57-29

Electrical Characteristics, $T_j = 25\text{ }^\circ\text{C}$ unless otherwise specified

Characteristics	Symbol	Test Conditions	Min.	Typ.	Max.	Units
IGBT Inverter Sector						
Collector Cutoff Current	I_{CEX}	$V_{CE} = V_{CEX}$, $T_j = 25\text{ }^\circ\text{C}$, Fig. 6	–	–	1	mA
Collector Cutoff Current	I_{CEX}	$V_{CE} = V_{CEX}$, $T_j = 125\text{ }^\circ\text{C}$, Fig. 6	–	–	10	mA
Diode Forward Voltage	V_{FM}	$-I_C = 10\text{A}$, $V_D = 15\text{V}$, $I_{CIN} = 1\text{mA}$, Fig. 3	–	1.5	2.5	Volts
Collector Emitter Saturation Voltage	$V_{CE(sat)}$	$V_D = 15\text{V}$, $I_{CIN} = 0\text{mA}$, $I_C = 10\text{A}$, Fig. 2	–	2.6	3.5	Volts
Collector Emitter Saturation Voltage	$V_{CE(sat)}$	$V_D = 15\text{V}$, $I_{CIN} = 0\text{mA}$, $I_C = 10\text{A}$, $T_j = 125\text{ }^\circ\text{C}$, Fig. 2	–	2.5	3.4	Volts
Inductive Load Switching Times	t_{on}	$V_D = 15\text{V}$, $I_{CIN} = 0\text{mA}$,	0.5	0.8	1.5	μS
	t_{rr}	$V_{CC} = 300\text{V}$, $I_C = 10\text{A}$,	–	0.15	0.4	μS
	$t_{C(on)}$	$T_j = 125\text{ }^\circ\text{C}$,	–	0.3	1.0	μS
	t_{off}	Fig. 4, Fig. 5	–	1.1	2.5	μS
	$t_{C(off)}$		–	0.5	1.5	μS

Thermal Characteristics

Characteristics	Symbol	Test Conditions	Min.	Typ.	Max.	Units
Junction to Case Thermal Resistances	$R_{th(I-C)Q}$	Inverter IGBT Part	–	–	3.2	$^\circ\text{C/W}$
	$R_{th(I-C)F}$	Inverter FWD	–	–	4.5	$^\circ\text{C/W}$
Contact Thermal Resistance	$R_{th(C-F)}$	Case to Fin, Thermal Grease Applied	–	–	0.4	$^\circ\text{C/W}$

Recommended Operating Conditions

Characteristics	Symbol	Test Conditions	Value	Units
Supply Voltage	V_{CC}	Applied across P-N Terminals	0 ~ 400	Volts
	V_D	Applied between $V_{UP1} - V_{UPC}$, $V_{N1} - V_{NC}$, $V_{VP1} - V_{VPC}$, $V_{WP1} - V_{WPC}$	15 ± 1.5	Volts
Input On Current	$I_{CIN(on)}$	Applied between	0 ~ 0.5	mA
Input Off Current	$I_{CIN(off)}$	$U_P, V_P, W_P, U_N, V_N, W_N$	0.5 ~ 2	mA
PWM Input Frequency	f_{PWM}	Using example Interface Circuit*	5 ~ 20	kHz
Minimum Dead Time	t_{DEAD}	Using example Interface Circuit*	5.0	μS

See Intellimod-3 Applications Data Section 4.3.

T-57-29

PM10CHA060
 Intellimod-3 Modules
 Three Phase IGBT Inverter Output
 10Amperes/110-230 Volt Line

SATURATION VOLTAGE CHARACTERISTICS (TYPICAL)

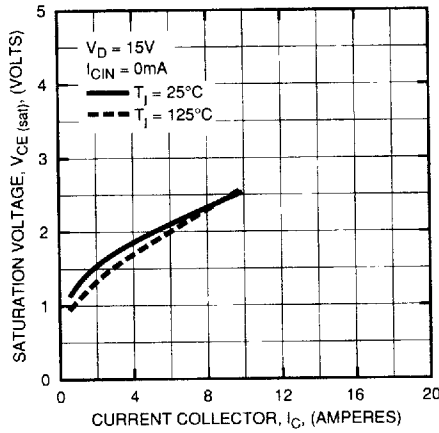

COLLECTOR-EMITTER SATURATION VOLTAGE (TYPICAL)

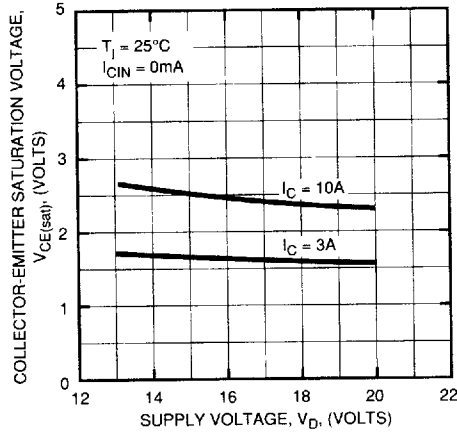

OUTPUT CHARACTERISTICS (TYPICAL)

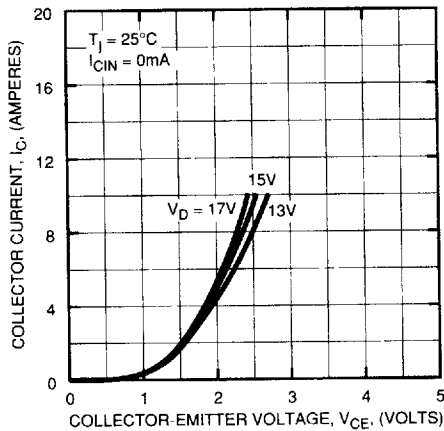

SWITCHING TIME VS. COLLECTOR CURRENT (TYPICAL)

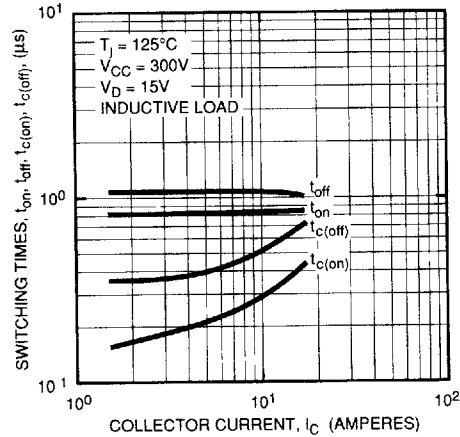

REVERSE RECOVERY CHARACTERISTICS OF FREE-WHEEL DIODE (TYPICAL)

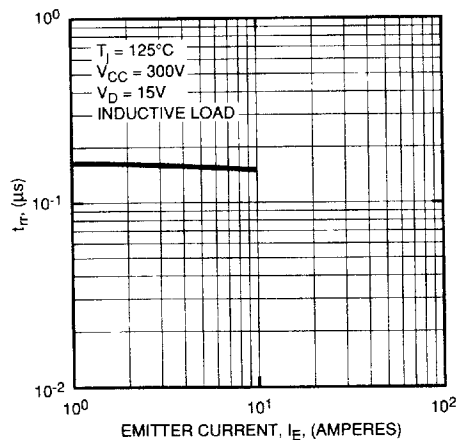

REVERSE COLLECTOR CURRENT VS. EMITTER-COLLECTOR VOLTAGE (DIODE FORWARD CHARACTERISTICS) (TYPICAL)

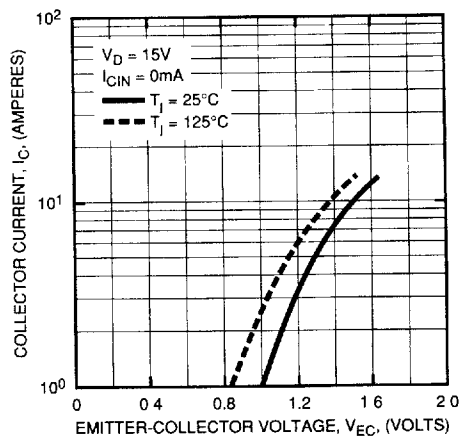

Powerex, Inc., Hillis Street, Youngwood, Pennsylvania 15697 (412) 925-7272
 Powerex, Europe, S.A. 428 Avenue G. Durand, BP107, 72003 Le Mans, France (43) 41.14.14

PM10CHA060
Intellimod-3 Modules
Three Phase IGBT Inverter Output
 10 Amperes/110-230 Volt Line

T-57-29

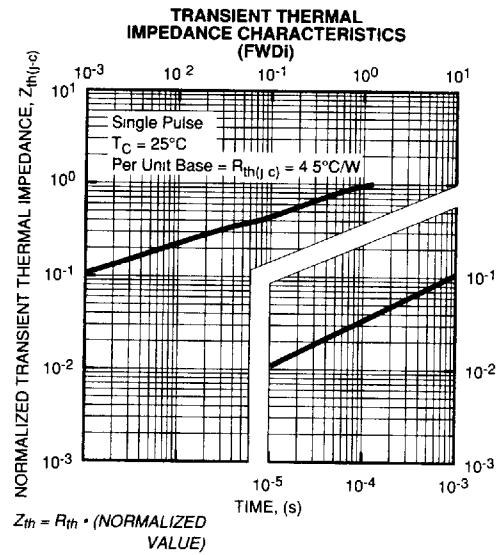
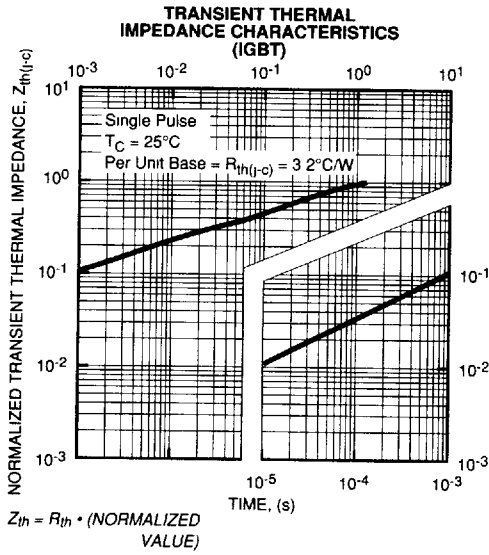
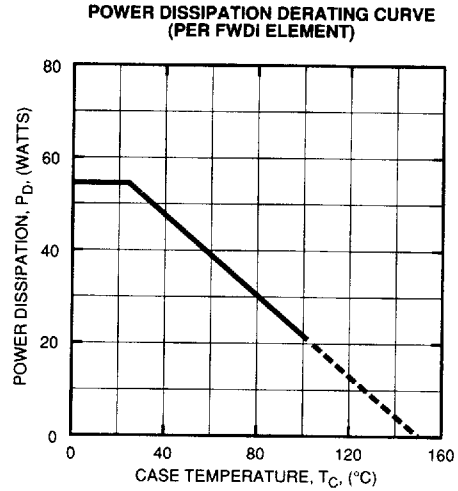
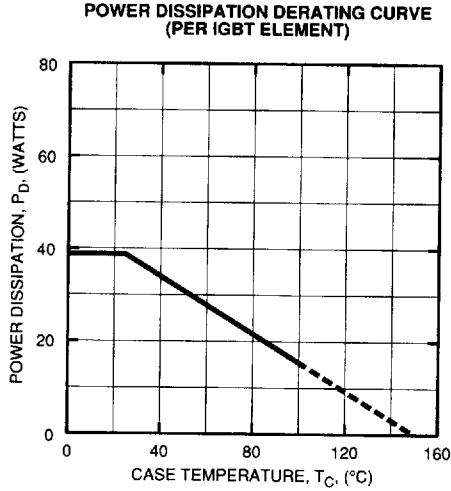

T-57-29

PM10CHA060
Intellimod-3 Modules
Three Phase IGBT Inverter Output
 10 Amperes/110-230 Volt Line

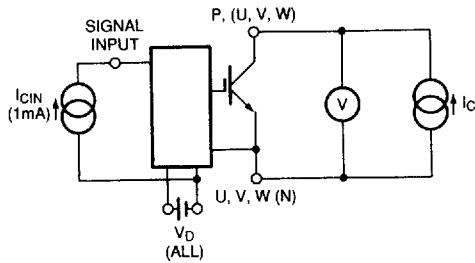

Figure 1 V_{CES} Test

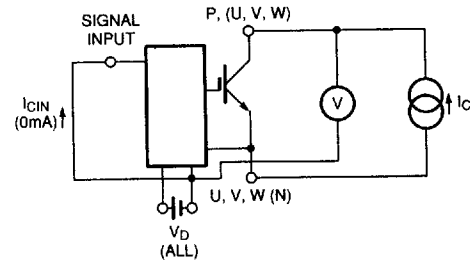

Figure 2 $V_{CE(SAT)}$ Test

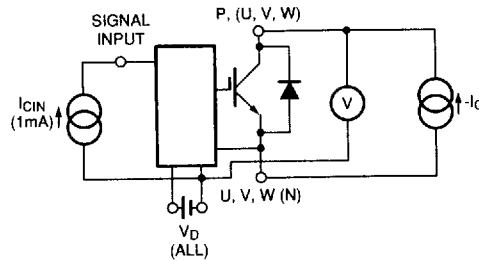
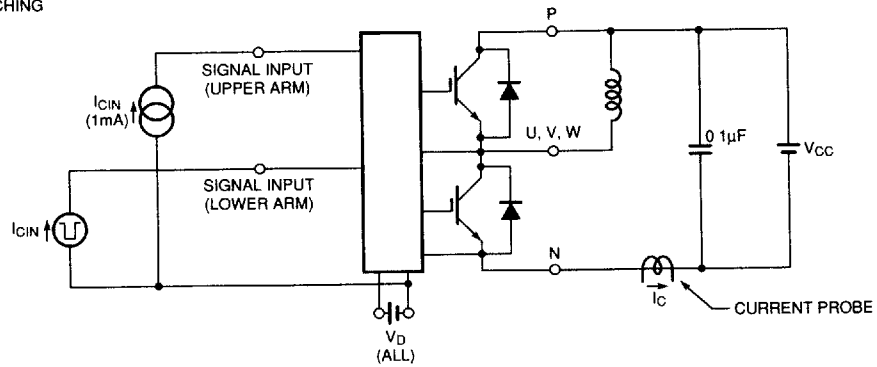

Figure 3 V_{EC} Test

A) LOWER ARM SWITCHING



B) UPPER ARM SWITCHING

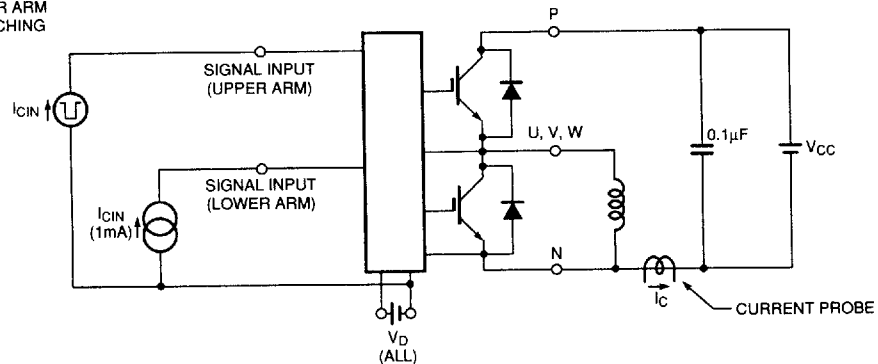

Figure 4 Switching Time Test

Powerex, Inc., Hillis Street, Youngwood, Pennsylvania 15697 (412) 925-7272
 Powerex, Europe, S.A. 428 Avenue G. Durand, BP107, 72003 Le Mans, France (43) 41.14.14

PM10CHA060
 Intellimod-3 Modules
 Three Phase IGBT Inverter Output
 10 Amperes/110-230 Volt Line

T-57-29

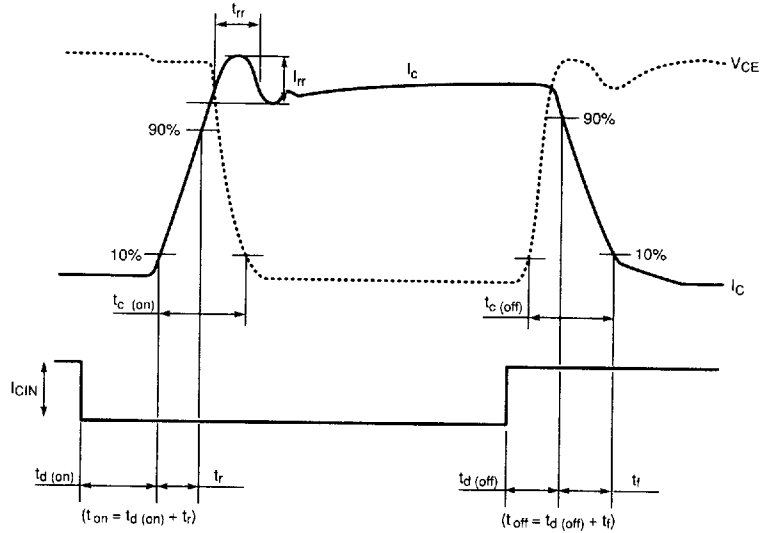

Figure 5 Switching Test Waveform

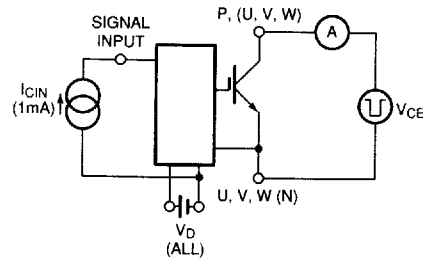

Figure 6 I_{CES} Test

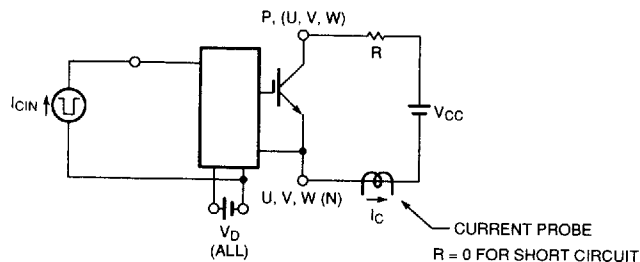

Figure 7 Over Current and Short Circuit Test