

# Numbering System

PDA9T9R9 22 10 is a 2200 Volt, Air Cooled Doubler Assembly.



## (1,2) Circuit Code:

- Rectifier
- SCR
- Half-Control
- Full-Control

### PA (AC Switch)

Powerex supplies the sink jumper (AC connection) on the PA air cooled assembly types only.



### PC (Positive Centertap – Common Cathode Connection)



### PD (Doubler Assemblies)

Remember to check the number of assemblies required for your circuit configuration.



### PN (Negative Centertap – Common Anode Connection)



### PP (Parallel Connection)

Connections available as Special Purpose Assemblies with selected device matching negotiated with Powerex application engineers.



- Rectifier
- SCR
- Half-Control
- Full-Control

### PR (Single Assemblies)

Remember to check the number of assemblies required for your circuit configuration.



### PS (Series Connection)

Connections available as Special Purpose Assemblies with the following options: device selection and matching; chill blocks and fittings (targets); disc clamp designs with additional spring deflection and additional voltage capabilities, corona (CIV, CEV) and Hipot testing, balancing capacitors, resistors.

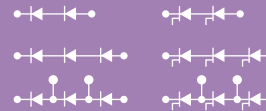

### PT (Single Assemblies)

Remember to check the number of assemblies required for your circuit configuration.



## (3,4) Sink Code: Customer Specific

## (5,6,7,8) Device Code: Application Specific

## (9,10) Voltage Code:

- 02 = 200
- 04 = 400
- 06 = 600
- 08 = 800
- 10 = 1000
- 12 = 1200
- 14 = 1400
- 16 = 1600
- 18 = 1800
- 20 = 2000
- 22 = 2200
- 24 = 2400
- 26 = 2600
- 28 = 2800
- 30 = 3000

## (11,12) Current Code: Customer Specific

## Three-Phase AC Switch Discs, Hockey Puks

Part Number	Voltage	Output Current Arms Amperes	Package Size (inches)	Quantity for 3-Phase	Ambient Temperature (°C)	Inlet Air Velocity (LFM)	Approximate Weight		Outline Drawings	
							(lbs)	(kgs)	Number	Page
PAA6T6200620	600	400	13.125 x 5.75 x 5.75	3	50	1000	12.8	5.8	1	J-12
PAA6T6201220	1200	400	13.125 x 5.75 x 5.75	3	50	1000	12.8	5.8	1	J-12
PAA6T6201620	1600	400	13.125 x 5.75 x 5.75	3	50	1000	12.8	5.8	1	J-12
PAA7T7200645	600	600	13.125 x 5.625 x 6.25	3	50	1000	13.7	6.2	2	J-12
PAA7T7201245	1200	600	13.125 x 5.625 x 6.25	3	50	1000	13.7	6.2	2	J-12
PAA7T7201645	1600	600	13.125 x 5.625 x 6.25	3	50	1000	13.7	6.2	2	J-12
PAA7T7200655	600	700	13.125 x 5.625 x 6.25	3	50	1000	13.7	6.2	2	J-12
PAA7T7201255	1200	700	13.125 x 5.625 x 6.25	3	50	1000	13.7	6.2	2	J-12
PAA7T7201655	1600	700	13.125 x 5.625 x 6.25	3	50	1000	13.7	6.2	2	J-12
PAA7T7S00675	600	800	13.125 x 5.625 x 5.80	3	50	1000	12.8	5.8	3	J-13
PAA7T7S01275	1200	800	13.125 x 5.625 x 5.80	3	50	1000	12.8	5.8	3	J-13
PAA7T7S01675	1600	800	13.125 x 5.625 x 5.80	3	50	1000	12.8	5.8	3	J-13
PAA9T9G00610	600	1350	17.125 x 9.938 x 6.44	3	50	1000	45.0	20.4	4	J-13
PAA9T9G01210	1200	1350	17.125 x 9.938 x 6.44	3	50	1000	45.0	20.4	4	J-13
PAA9T9G01610	1600	1350	17.125 x 9.938 x 6.44	3	50	1000	45.0	20.4	4	J-13
PAA9T9G00612	600	1700	17.125 x 9.938 x 6.44	3	50	1000	45.0	20.4	4	J-13
PAA9T9G01212	1200	1700	17.125 x 9.938 x 6.44	3	50	1000	45.0	20.4	4	J-13
PAA9T9G01612	1600	1700	17.125 x 9.938 x 6.44	3	50	1000	45.0	20.4	4	J-13
PAAATA200616	600	2100	21.12 x 12.69 x 7.84	3	50	1000	86.4	39.2	5	J-14
PAAATA201216	1200	2100	21.12 x 12.69 x 7.84	3	50	1000	86.4	39.2	5	J-14
PAAATA201616	1600	2100	21.12 x 12.69 x 7.84	3	50	1000	86.4	39.2	5	J-14
PAAATA200618	600	2500	21.12 x 12.69 x 7.84	3	50	1000	86.4	39.2	5	J-14
PAAATA201218	1200	2500	21.12 x 12.69 x 7.84	3	50	1000	86.4	39.2	5	J-14
PAAATA201618	1600	2500	21.12 x 12.69 x 7.84	3	50	1000	86.4	39.2	5	J-14



Single Phase Assembly –  
3 Required for Three-Phase Circuit

# Three-Phase AC Switch

## Isolated Modules

Part Number	Voltage	Output Current A <sub>rms</sub> Amperes	Package Size (inches)	Quantity for 3-Phase	Ambient Temperature (°C)	Inlet Air Velocity (LFM)	Approximate Weight		Outline Drawings	
							(lbs)	(kgs)	Number	Page
PAB1CD430890	600	100	6.00 x 4.92 x 7.00	1	50	800	6.8	3.1	6	J-14
PAB1CD431290	1200	100	6.00 x 4.92 x 7.00	1	50	800	6.8	3.1	6	J-14
PAB1CD431690	1600	100	6.00 x 4.92 x 7.00	1	50	800	6.8	3.1	6	J-14
PAB2CD630815	600	150	9.00 x 4.92 x 7.00	1	50	800	11.0	5.0	8	J-15
PAB2CD631215	1200	150	9.00 x 4.92 x 7.00	1	50	800	11.0	5.0	8	J-15
PAB2CD631615	1600	150	9.00 x 4.92 x 7.00	1	50	800	11.0	5.0	8	J-15
PAB3ND430825	600	200	12.00 x 4.92 x 8.00	1	50	800	18.75	8.5	10	J-16
PAB3ND431225	1200	200	12.00 x 4.92 x 8.00	1	50	800	18.75	8.5	10	J-16
PAB3ND431625	1600	200	12.00 x 4.92 x 8.00	1	50	800	18.75	8.5	10	J-16
PAB2LD430850	600	300	9.00 x 4.92 x 8.00	3	50	800	12.5	5.6	12	J-16
PAB2LD431250	1200	300	9.00 x 4.92 x 8.00	3	50	800	12.5	5.6	12	J-16
PAB2LD431650	1600	300	9.00 x 4.92 x 8.00	3	50	800	12.5	5.6	12	J-16

PAB1CD430890, PAB1CD431290, PAB1CD431690,  
PAB2CD630815, PAB2CD631215, PAB2CD631615,  
PAB3ND430825, PAB3ND431225, PAB3ND431625

PAB2LD430850, PAB2LD431250, PAB2LD431650



Single Phase Assembly –  
3 Required for Three-Phase Circuit

## Three-Phase DC Rectifier Discs, Hockey Pucks

Part Number	Voltage	Output Current Apc Amperes	Package Size (inches)	Quantity for 3-Phase	Ambient Temperature (°C)	Inlet Air Velocity (LFM)	Approximate Weight		Outline Drawings	
							(lbs)	(kgs)	Number	Page
PDA6R6200630	600	850	13.125 x 5.75 x 5.75	3	50	1000	12.8	5.8	1	J-12
PDA6R6201230	1200	850	13.125 x 5.75 x 5.75	3	50	1000	12.8	5.8	1	J-12
PDA6R6201630	1600	850	13.125 x 5.75 x 5.75	3	50	1000	12.8	5.8	1	J-12
PDA7R7S00608	600	1200	13.125 x 5.625 x 5.80	3	50	1000	12.8	5.8	3	J-13
PDA7R7S01208	1200	1200	13.125 x 5.625 x 5.80	3	50	1000	12.8	5.8	3	J-13
PDA7R7S01608	1600	1200	13.125 x 5.625 x 5.80	3	50	1000	12.8	5.8	3	J-13
PDA7R7S00612	600	1650	13.125 x 5.625 x 5.80	3	50	1000	12.8	5.8	3	J-13
PDA7R7S01212	1200	1650	13.125 x 5.625 x 5.80	3	50	1000	12.8	5.8	3	J-13
PDA7R7S01612	1600	1650	13.125 x 5.625 x 5.80	3	50	1000	12.8	5.8	3	J-13
PDA7R7S00616	600	2450	13.125 x 5.625 x 5.80	3	50	1000	12.8	5.8	3	J-13
PDA7R7S01216	1200	2450	13.125 x 5.625 x 5.80	3	50	1000	12.8	5.8	3	J-13
PDA7R7S01616	1600	2450	13.125 x 5.625 x 5.80	3	50	1000	12.8	5.8	3	J-13
PDA9R9G00612	600	2700	17.125 x 9.938 x 6.44	3	50	1000	45.0	20.4	4	J-13
PDA9R9G01212	1200	2700	17.125 x 9.938 x 6.44	3	50	1000	45.0	20.4	4	J-13
PDA9R9G01612	1600	2700	17.125 x 9.938 x 6.44	3	50	1000	45.0	20.4	4	J-13
PDA9R9G00618	600	3300	17.125 x 9.938 x 6.44	3	50	1000	45.0	20.4	4	J-13
PDA9R9G01218	1200	3300	17.125 x 9.938 x 6.44	3	50	1000	45.0	20.4	4	J-13
PDA9R9G01618	1600	3300	17.125 x 9.938 x 6.44	3	50	1000	45.0	20.4	4	J-13
PDA9R9G00622	600	4500	17.125 x 9.938 x 6.44	3	50	1000	45.0	20.4	4	J-13
PDA9R9G01222	1200	4500	17.125 x 9.938 x 6.44	3	50	1000	45.0	20.4	4	J-13
PDA9R9G01622	1600	4500	17.125 x 9.938 x 6.44	3	50	1000	45.0	20.4	4	J-13
PDAARA200636	600	5800	21.12 x 12.69 x 7.84	3	50	1000	86.4	39.2	5	J-14
PDAARA201236	1200	5800	21.12 x 12.69 x 7.84	3	50	1000	86.4	39.2	5	J-14
PDAARA201636	1600	5800	21.12 x 12.69 x 7.84	3	50	1000	86.4	39.2	5	J-14



Single Phase Assembly –  
3 Required for Three-Phase Circuit

## Three-Phase DC Rectifier Isolated Modules

Part Number	Voltage	Output Current A <sub>DC</sub> Amperes	Package Size (inches)	Quantity for 3-Phase	Ambient Temperature (°C)	Inlet Air Velocity (LFM)	Approximate Weight		Outline Drawings	
							(lbs)	(kgs)	Number	Page
PDB1CD410899	600	150	6.00 x 4.92 x 7.00	1	50	800	6.8	3.1	7	J-15
PDB1CD411299	1200	150	6.00 x 4.92 x 7.00	1	50	800	6.8	3.1	7	J-15
PDB1CD411699	1600	150	6.00 x 4.92 x 7.00	1	50	800	6.8	3.1	7	J-15
PDB2CD610816	600	200	9.00 x 4.92 x 7.00	1	50	800	11.0	5.0	9	J-15
PDB2CD611216	1200	200	9.00 x 4.92 x 7.00	1	50	800	11.0	5.0	9	J-15
PDB2CD611616	1600	200	9.00 x 4.92 x 7.00	1	50	800	11.0	5.0	9	J-15
PDB3ND410626	600	300	15.00 x 4.92 x 8.00	1	50	800	18.75	8.5	11	J-16
PDB3ND411226	1200	300	15.00 x 4.92 x 8.00	1	50	800	18.75	8.5	11	J-16
PDB3ND411626	1600	300	15.00 x 4.92 x 8.00	1	50	800	18.75	8.5	11	J-16
PDB2LD410860	600	450	9.00 x 4.92 x 8.00	3	50	800	12.5	5.6	12	J-16
PDB2LD411260	1200	450	9.00 x 4.92 x 8.00	3	50	800	12.5	5.6	12	J-16
PDB2LD411660	1600	450	9.00 x 4.92 x 8.00	3	50	800	12.5	5.6	12	J-16

PDB1CD410899, PDB1CD411299, PDB1CD411699,  
PDB2CD610816, PDB2CD611216, PDB2CD611616,  
PDB3ND410626, PDB3ND411226, PDB3ND411626

PDB2LD410860, PDB2LD411260, PDB2LD411660

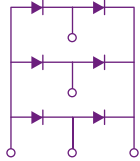

## Three-Phase Half Controlled Rectifier Discs, Hockey Pucks

Part Number	Voltage	Output Current Apc Amperes	Package Size (inches)	Quantity for 3-Phase	Ambient Temperature (°C)	Inlet Air Velocity (LFM)	Approximate Weight		Outline Drawings	
							(lbs)	(kgs)	Number	Page
PDA6T6R60620	600	500	13.125 x 5.75 x 5.75	3	50	1000	12.8	5.8	1	J-12
PDA6T6R61220	1200	500	13.125 x 5.75 x 5.75	3	50	1000	12.8	5.8	1	J-12
PDA6T6R61620	1600	500	13.125 x 5.75 x 5.75	3	50	1000	12.8	5.8	1	J-12
PDA6T6R60630	600	600	13.125 x 5.75 x 5.75	3	50	1000	12.8	5.8	1	J-12
PDA6T6R61230	1200	600	13.125 x 5.75 x 5.75	3	50	1000	12.8	5.8	1	J-12
PDA6T6R61630	1600	600	13.125 x 5.75 x 5.75	3	50	1000	12.8	5.8	1	J-12
PDA7T7R70645	600	800	13.125 x 5.625 x 6.25	3	50	1000	13.7	6.2	2	J-12
PDA7T7R71245	1200	800	13.125 x 5.625 x 6.25	3	50	1000	13.7	6.2	2	J-12
PDA7T7R71645	1600	800	13.125 x 5.625 x 6.25	3	50	1000	13.7	6.2	2	J-12
PDA7TSRS0665	600	950	13.125 x 5.625 x 5.80	3	50	1000	12.8	5.8	3	J-13
PDA7TSRS1265	1200	950	13.125 x 5.625 x 5.80	3	50	1000	12.8	5.8	3	J-13
PDA7TSRS1665	1600	950	13.125 x 5.625 x 5.80	3	50	1000	12.8	5.8	3	J-13
PDA7TSRS0675	600	1000	13.125 x 5.625 x 5.80	3	50	1000	12.8	5.8	3	J-13
PDA7TSRS1275	1200	1000	13.125 x 5.625 x 5.80	3	50	1000	12.8	5.8	3	J-13
PDA7TSRS1675	1600	1000	13.125 x 5.625 x 5.80	3	50	1000	12.8	5.8	3	J-13
PDA9T9R90610	600	1750	17.125 x 9.938 x 6.44	3	50	1000	45.0	20.4	4	J-13
PDA9T9R91210	1200	1750	17.125 x 9.938 x 6.44	3	50	1000	45.0	20.4	4	J-13
PDA9T9R91610	1600	1750	17.125 x 9.938 x 6.44	3	50	1000	45.0	20.4	4	J-13
PDA9T9R90612	600	2200	17.125 x 9.938 x 6.44	3	50	1000	45.0	20.4	4	J-13
PDA9T9R91212	1200	2200	17.125 x 9.938 x 6.44	3	50	1000	45.0	20.4	4	J-13
PDA9T9R91612	1600	2200	17.125 x 9.938 x 6.44	3	50	1000	45.0	20.4	4	J-13
PDAATARA0618	600	3300	21.12 x 12.69 x 7.84	3	50	1000	86.4	39.2	5	J-14
PDAATARA1218	1200	3300	21.12 x 12.69 x 7.84	3	50	1000	86.4	39.2	5	J-14
PDAATARA1618	1600	3300	21.12 x 12.69 x 7.84	3	50	1000	86.4	39.2	5	J-14



Single Phase Assembly –  
3 Required for Three-Phase Circuit

## Three-Phase Half Controlled Rectifier Isolated Modules

Part Number	Voltage	Output Current A <sub>DC</sub> Amperes	Package Size (inches)	Quantity for 3-Phase	Ambient Temperature (°C)	Inlet Air Velocity (LFM)	Approximate Weight		Outline Drawings	
							(lbs)	(kgs)	Number	Page
PDB1CD420890	600	150	6.00 x 4.92 x 7.00	1	50	800	6.8	3.1	7	J-15
PDB1CD421290	1200	150	6.00 x 4.92 x 7.00	1	50	800	6.8	3.1	7	J-15
PDB1CD421690	1600	150	6.00 x 4.92 x 7.00	1	50	800	6.8	3.1	7	J-15
PDB2CD620815	600	200	9.00 x 4.92 x 7.00	1	50	800	11.0	5.0	9	J-15
PDB2CD621215	1200	200	9.00 x 4.92 x 7.00	1	50	800	11.0	5.0	9	J-15
PDB2CD621615	1600	200	9.00 x 4.92 x 7.00	1	50	800	11.0	5.0	9	J-15
PDB3ND420625	600	300	15.00 x 4.92 x 8.00	1	50	800	18.75	8.5	11	J-16
PDB3ND421225	1200	300	15.00 x 4.92 x 8.00	1	50	800	18.75	8.5	11	J-16
PDB3ND421625	1600	300	15.00 x 4.92 x 8.00	1	50	800	18.75	8.5	11	J-16
PDB2LD420850	600	450	9.00 x 4.92 x 8.00	3	50	800	12.5	5.6	12	J-16
PDB2LD421250	1200	450	9.00 x 4.92 x 8.00	3	50	800	12.5	5.6	12	J-16
PDB2LD421650	1600	450	9.00 x 4.92 x 8.00	3	50	800	12.5	5.6	12	J-16

PDB1CD420890, PDB1CD421290, PDB1CD421690,  
PDB2CD620815, PDB2CD621215, PDB2CD621615,  
PDB3ND420625, PDB3ND421225, PDB3ND421625

PDB2LD420850, PDB2LD421250, PDB2LD421650



## Three-Phase Full Controlled Rectifier Discs, Hockey Puks

Part Number	Voltage	Output Current Apc Amperes	Package Size (inches)	Quantity for 3-Phase	Ambient Temperature (°C)	Inlet Air Velocity (LFM)	Approximate Weight		Outline Drawings	
							(lbs)	(kgs)	Number	Page
PDA6T6200620	600	500	13.125 x 5.75 x 5.75	3	50	1000	12.8	5.8	1	J-12
PDA6T6201220	1200	500	13.125 x 5.75 x 5.75	3	50	1000	12.8	5.8	1	J-12
PDA6T6201620	1600	500	13.125 x 5.75 x 5.75	3	50	1000	12.8	5.8	1	J-12
PDA6T6200630	600	600	13.125 x 5.75 x 5.75	3	50	1000	12.8	5.8	1	J-12
PDA6T6201230	1200	600	13.125 x 5.75 x 5.75	3	50	1000	12.8	5.8	1	J-12
PDA6T6201630	1600	600	13.125 x 5.75 x 5.75	3	50	1000	12.8	5.8	1	J-12
PDA7T7200645	600	800	13.125 x 5.625 x 6.25	3	50	1000	13.7	6.2	2	J-12
PDA7T7201245	1200	800	13.125 x 5.625 x 6.25	3	50	1000	13.7	6.2	2	J-12
PDA7T7201645	1600	800	13.125 x 5.625 x 6.25	3	50	1000	13.7	6.2	2	J-12
PDA7T7S00665	600	950	13.125 x 5.625 x 5.80	3	50	1000	12.8	5.8	3	J-13
PDA7T7S01265	1200	950	13.125 x 5.625 x 5.80	3	50	1000	12.8	5.8	3	J-13
PDA7T7S01665	1600	950	13.125 x 5.625 x 5.80	3	50	1000	12.8	5.8	3	J-13
PDA7T7S00675	600	1000	13.125 x 5.625 x 5.80	3	50	1000	12.8	5.8	3	J-13
PDA7T7S01275	1200	1000	13.125 x 5.625 x 5.80	3	50	1000	12.8	5.8	3	J-13
PDA7T7S01675	1600	1000	13.125 x 5.625 x 5.80	3	50	1000	12.8	5.8	3	J-13
PDA9T9G00610	600	1750	17.125 x 9.938 x 6.44	3	50	1000	45.0	20.4	4	J-13
PDA9T9G01210	1200	1750	17.125 x 9.938 x 6.44	3	50	1000	45.0	20.4	4	J-13
PDA9T9G01610	1600	1750	17.125 x 9.938 x 6.44	3	50	1000	45.0	20.4	4	J-13
PDA9T9G00612	600	2200	17.125 x 9.938 x 6.44	3	50	1000	45.0	20.4	4	J-13
PDA9T9G01212	1200	2200	17.125 x 9.938 x 6.44	3	50	1000	45.0	20.4	4	J-13
PDA9T9G01612	1600	2200	17.125 x 9.938 x 6.44	3	50	1000	45.0	20.4	4	J-13
PDAATA200618	600	3300	21.12 x 12.69 x 7.84	3	50	1000	86.4	39.2	5	J-14
PDAATA201218	1200	3300	21.12 x 12.69 x 7.84	3	50	1000	86.4	39.2	5	J-14
PDAATA201618	1600	3300	21.12 x 12.69 x 7.84	3	50	1000	86.4	39.2	5	J-14



Single Phase Assembly –  
3 Required for Three-Phase Circuit



# Three-Phase Full Controlled Rectifier Isolated Modules

Part Number	Voltage	Output Current A <sub>DC</sub> Amperes	Package Size (inches)	Quantity for 3-Phase	Ambient Temperature (°C)	Inlet Air Velocity (LFM)	Approximate Weight		Outline Drawings	
							(lbs)	(kgs)	Number	Page
PDB1CD430890	600	150	6.00 x 4.92 x 7.00	1	50	800	6.8	3.1	7	J-15
PDB1CD431290	1200	150	6.00 x 4.92 x 7.00	1	50	800	6.8	3.1	7	J-15
PDB1CD431690	1600	150	6.00 x 4.92 x 7.00	1	50	800	6.8	3.1	7	J-15
PDB2CD630815	600	200	9.00 x 4.92 x 7.00	1	50	800	11.0	5.0	9	J-15
PDB2CD631215	1200	200	9.00 x 4.92 x 7.00	1	50	800	11.0	5.0	9	J-15
PDB2CD631615	1600	200	9.00 x 4.92 x 7.00	1	50	800	11.0	5.0	9	J-15
PDB3ND430625	600	300	15.00 x 4.92 x 8.00	1	50	800	18.75	8.5	11	J-16
PDB3ND431225	1200	300	15.00 x 4.92 x 8.00	1	50	800	18.75	8.5	11	J-16
PDB3ND431625	1600	300	15.00 x 4.92 x 8.00	1	50	800	18.75	8.5	11	J-16
PDB2LD430850	600	450	9.00 x 4.92 x 8.00	3	50	800	12.5	5.6	12	J-16
PDB2LD431250	1200	450	9.00 x 4.92 x 8.00	3	50	800	12.5	5.6	12	J-16
PDB2LD431650	1600	450	9.00 x 4.92 x 8.00	3	50	800	12.5	5.6	12	J-16

PDB1CD430890, PDB1CD431290, PDB1CD431690,  
PDB2CD630815, PDB2CD631215, PDB2CD631615,  
PDB3ND430625, PDB3ND431225, PDB3ND431625

PDB2LD430850, PDB2LD431250, PDB2LD431650

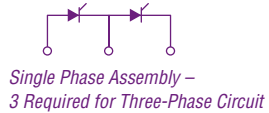
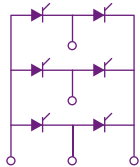

**1** PAA6T6200620, PAA6T6201220, PAA6T6201620, PDA6R6200630, PDA6R6201230, PDA6R6201630, PDA6T6200620, PDA6T6200630, PDA6T6201220, PDA6T6201230, PDA6T6201620, PDA6T6201630, PDA6T6R60620, PDA6T6R60630, PDA6T6R61220, PDA6T6R61230, PDA6T6R61620, PDA6T6R61630

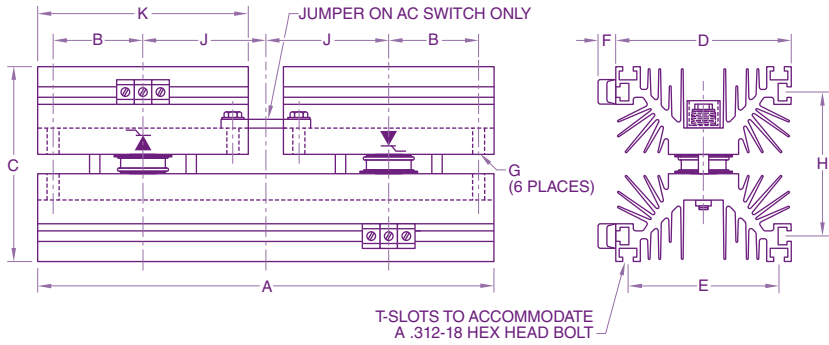

Dim.	Inches	Millimeters
A	13.06 Max.	331.72 Max.
B	2.56	65.0
C	5.60 Max.	142.24 Max.
D	5.06 Max.	128.52 Max.
E	4.25 Ref.	107.9 Ref.
F	0.5 Ref.	12.7 Ref.
G	0.344 Dia.	8.75 Dia.
H	4.10 Ref.	104.14 Ref.
J	3.5 Ref.	88.9 Ref.
K	6.0 Ref.	152.4 Ref.

**2** PAA7T7200645, PAA7T7200655, PAA7T7201245, PAA7T7201255, PAA7T7201645, PAA7T7201655, PDA7T7200645, PDA7T7201245, PDA7T7201645, PDA7T7R70645, PDA7T7R71245, PDA7T7R71645

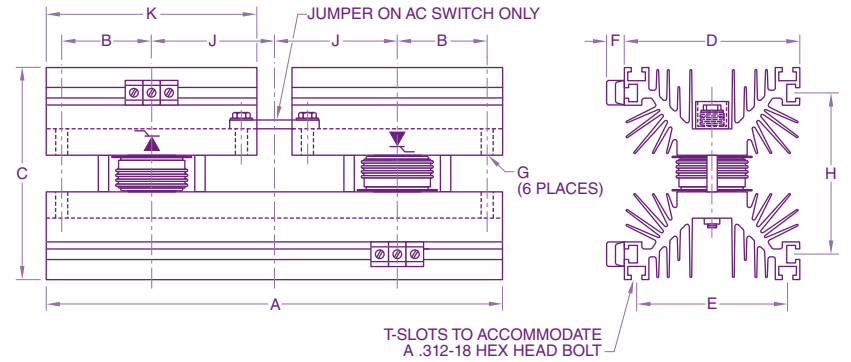

Dim.	Inches	Millimeters
A	13.06 Max.	331.72 Max.
B	2.56	65.0
C	6.06 Max.	153.92 Max.
D	5.06 Max.	128.52 Max.
E	4.25 Ref.	107.9 Ref.
F	0.5 Ref.	12.7 Ref.
G	0.344 Dia.	8.75 Dia.
H	4.59 Ref.	116.58 Ref.
J	3.5 Ref.	88.9 Ref.
K	6.0 Ref.	152.4 Ref.

3

PAA7T7S00675, PAA7T7S01275, PAA7T7S01675, PDA7R7S00608, PDA7R7S00612, PDA7R7S00616, PDA7R7S01208, PDA7R7S01212, PDA7R7S01216, PDA7R7S01608, PDA7R7S01612, PDA7R7S01616, PDA7TSRS0665, PDA7TSRS0675, PDA7TSRS1265, PDA7TSRS1275, PDA7TSRS1665, PDA7TSRS1675, PDA7T7S00665, PDA7T7S00675, PDA7T7S01265, PDA7T7S01275, PDA7T7S01665, PDA7T7S01675



Dim.	Inches	Millimeters
A	13.06 Max.	331.72 Max.
B	2.56	65.0
C	5.64 Max.	143.26 Max.
D	5.06 Max.	128.52 Max.
E	4.25 Ref.	107.9 Ref.
F	0.5 Ref.	12.7 Ref.
G	0.344 Dia.	8.75 Dia.
H	4.13 Ref.	104.9 Ref.
J	3.5 Ref.	88.9 Ref.
K	6.0 Ref.	152.4 Ref.

4

PAA9T9G00610, PAA9T9G00612, PAA9T9G01210, PAA9T9G01212, PAA9T9G01610, PAA9T9G01612, PDA9R9G00612, PDA9R9G00618, PDA9R9G00622, PDA9R9G01212, PDA9R9G01218, PDA9R9G01222, PDA9R9G01612, PDA9R9G01618, PDA9R9G01622, PDA9T9G00610, PDA9T9G00612, PDA9T9G01210, PDA9T9G01212, PDA9T9G01610, PDA9T9G01612, PDA9T9R90610, PDA9T9R90612, PDA9T9R91210, PDA9T9R91212, PDA9T9R91610, PDA9T9R91612



Dim.	Inches	Millimeters
A	17.06 Max.	433.32 Max.
B	2.5	63.5
C	6.3 Max.	160.02 Max.
D	9.86 Max.	250.95 Max.
E	1.0	25.4
F	0.75 Ref.	19.05 Ref.
G	0.375 Dia.	9.525 Dia.
H	2.16 Ref.	54.86 Ref.
J	4.5 Ref.	114.3 Ref.
K	8.0 Ref.	203.2 Ref.
L	0.5 Max.	12.7 Max.
M	0.33 Ref.	8.38 Ref.

**5** PAAATA200616, PAAATA200618, PAAATA201216, PAAATA201218, PAAATA201616, PAAATA201618, PDAARA200636, PDAARA201236, PDAARA201636, PDAATARA0618, PDAATARA1218, PDAATARA1618, PDAATA200618, PDAATA201218, PDAATA201618



Dim.	Inches	Millimeters
A	21.06 Max.	534.92 Max.
B	10.0 Ref.	254.0 Ref.
C	7.89 Max.	200.4 Max.
D	12.69 Max.	322.33 Max.
E	1.0	25.4
F	1.75	44.45
G	0.81	20.57
H	5.50	139.7
J	0.58 Ref.	14.73 Ref.
K	0.65 Ref.	16.51 Ref.

**6** PAB1CD430890, PAB1CD431290, PAB1CD431690



Dim.	Inches	Millimeters
A	6.0	152.5
B	7.0 Max.	177.83 Max.
C	4.92 Max.	125.0 Max.
D	1.0	25.4
E	2.0	50.8
F	4.53	115.06
G	4.33	109.98
H	0.79	20.07
J	1.5	31.1

7

PDB1CD410899, PDB1CD411299, PDB1CD411699,  
PDB1CD420890, PDB1CD421290, PDB1CD421690,  
PDB1CD430890, PDB1CD431290, PDB1CD431690



Dim.	Inches	Millimeters
A	6.0	152.5
B	7.0 Max.	177.83 Max.
C	4.92 Max.	125.0 Max.
D	1.0	25.4
E	2.0	50.8
F	4.53	115.06
G	4.33	109.98
H	0.79	20.07
J	1.5	31.1

8

PAB2CD630815, PAB2CD631215, PAB2CD631615



Dim.	Inches	Millimeters
A	9.0	228.6
B	7.0 Max.	177.83 Max.
C	4.92 Max.	125.0 Max.
D	1.5	31.1
E	3.0	76.2
F	4.53	115.06
G	4.33	109.98
H	0.91	23.11
J	1.56	39.62

9

PDB2CD610816, PDB2CD611216, PDB2CD611616,  
PDB2CD620815, PDB2CD621215, PDB2CD621615,  
PDB2CD630815, PDB2CD631215, PDB2CD631615

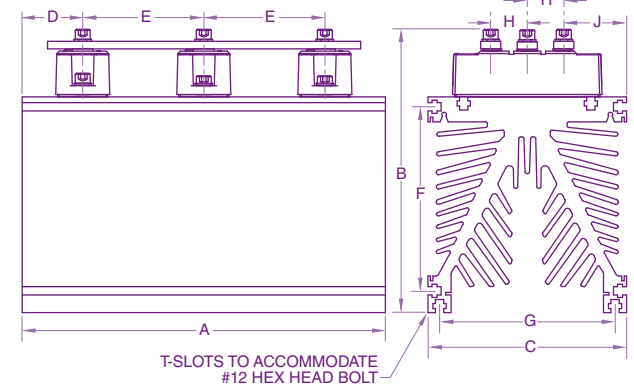

Dim.	Inches	Millimeters
A	9.0	228.6
B	7.0 Max.	177.83 Max.
C	4.92 Max.	125.0 Max.
D	1.5	31.1
E	3.0	76.2
F	4.53	115.06
G	4.33	109.98
H	0.91	23.11
J	1.56	39.62

**10** PAB3ND430825, PAB3ND431225, PAB3ND431625



Dim.	Inches	Millimeters
A	12.0	304.8
B	8.0 Max.	203.2 Max.
C	4.92 Max.	125.0 Max.
D	2.0	50.8
E	4.0	101.6
F	4.53	115.06
G	4.33	109.98
H	1.7	43.18
J	1.38	35.05
K	1.77	44.96

**11** PDB3ND410626, PDB3ND411226, PDB3ND411626, PDB3ND420625, PDB3ND421225, PDB3ND421625, PDB3ND430625, PDB3ND431225, PDB3ND431625



Dim.	Inches	Millimeters
A	12.0	304.8
B	8.0 Max.	203.2 Max.
C	4.92 Max.	125.0 Max.
D	2.0	50.8
E	4.0	101.6
F	4.53	115.06
G	4.33	109.98
H	1.7	43.18
J	1.38	35.05
K	1.77	44.96

**12** PAB2LD430850, PAB2LD431250, PAB2LD431650, PDB2LD410860, PDB2LD411260, PDB2LD411660, PDB2LD420850, PDB2LD421250, PDB2LD421650, PDB2LD430850, PDB2LD431250, PDB2LD431650



Dim.	Inches	Millimeters
A	9.0	228.6
B	8.0 Max.	203.2 Max.
C	4.92 Max.	125.0 Max.
D	1.78	45.21
E	1.73	43.94
F	4.53	115.06
G	4.33	109.98
H	2.46	62.48
J	1.97	50.04