

POW-R-BLOK™
Dual SCR Isolated Module
700 Amperes / Up to 1800 Volts

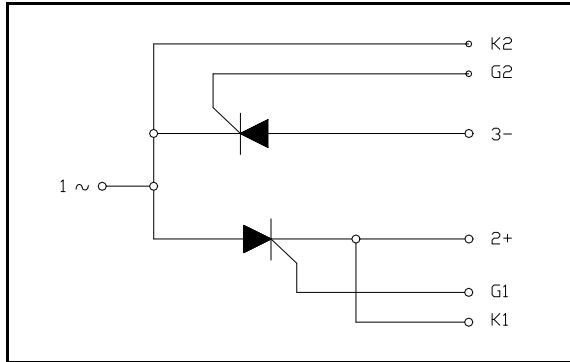

Ordering Information:

Select the complete eight-digit module part number from the table below.

Example: PD431807 is a 1800 Volt, 700A Average Dual SCR Isolated POW-R-BLOK™ Module

Type	Voltage Volts (x100)	Current Amperes (x100)
PD43	12	07
	14	
	16	
	18	

Description:

Powerex Dual SCR Modules are designed for use in applications requiring phase control and isolated packaging. The modules are isolated for easy mounting with other components on a common heatsink.

Features:

- Electrically Isolated Heatsinking
- Compression Bonded Elements
- Metal Baseplate
- Low Thermal Impedance for Improved Current Capability
- UL Recognized (E78240)

Benefits:

- No Additional Insulation Components Required
- Easy Installation
- No Clamping Components Required
- Reduce Engineering Time

Applications:

- Bridge Circuits
- AC & DC Motor Drives
- Motor Soft Starters
- Battery Supplies
- Power Supplies
- Large IGBT Circuit Front Ends

Absolute Maximum Ratings

Characteristics	Conditions	Symbol	Units
Repetitive Peak Forward and Reverse Blocking Voltage		V_{DRM} & V_{RRM}	Up to 1800 V
Non-Repetitive Peak Blocking Voltage ($t < 5$ msec)		V_{RSM}	$V_{RRM} + 100V$ V
RMS Current AC Switch Configuration (180° Conduction)	180° Conduction, $T_C=74^\circ C$	$I_{T(RMS)}$	1775 A
	180° Conduction, $T_C=78^\circ C$	$I_{T(RMS)}$	1665 A
	180° Conduction, $T_C=82^\circ C$	$I_{T(RMS)}$	1550 A
	180° Conduction, $T_C=86^\circ C$	$I_{T(RMS)}$	1440 A
RMS Current Per SCR (180° Conduction)	180° Conduction, $T_C=74^\circ C$	$I_{T(RMS)}$	1256 A
	180° Conduction, $T_C=78^\circ C$	$I_{T(RMS)}$	1178 A
	180° Conduction, $T_C=82^\circ C$	$I_{T(RMS)}$	1100 A
	180° Conduction, $T_C=86^\circ C$	$I_{T(RMS)}$	1020 A
Average Forward Current Per SCR (180° Conduction)	180° Conduction, $T_C=74^\circ C$	$I_{T(AV)}$	800 A
	180° Conduction, $T_C=78^\circ C$	$I_{T(AV)}$	750 A
	180° Conduction, $T_C=82^\circ C$	$I_{T(AV)}$	700 A
	180° Conduction, $T_C=86^\circ C$	$I_{T(AV)}$	650 A
Peak One Cycle Surge Current, Non-Repetitive $T_j = 25C, V_r = 0$	60 Hz	I_{TSM}	69,000 A
	50 Hz	I_{TSM}	63,000 A
Peak One Cycle Surge Current, Non-Repetitive $T_j = 25C, V_r = V_{rrm}$	60 Hz	I_{TSM}	46,000 A
	50 Hz	I_{TSM}	42,000 A
Peak One Cycle Surge Current, Non-Repetitive $T_j = 125C, V_r = 0$	60 Hz	I_{TSM}	60,000 A
	50 Hz	I_{TSM}	54,750 A
Peak One Cycle Surge Current, Non-Repetitive $T_j = 125C, V_r = V_{rrm}$	60 Hz	I_{TSM}	40,000 A
	50 Hz	I_{TSM}	36,500 A
Peak Three Cycle Surge Current, Non-Repetitive	60 Hz, $T_j = 125C, V_r = V_{rrm}$	I_{TSM}	32,100 A
Peak Ten Cycle Surge Current, Non-Repetitive	60 Hz, $T_j = 125C, V_r = V_{rrm}$	I_{TSM}	25,200 A
I^2t for Fusing for One Cycle $T_j = 125C, V_r = V_{rrm}$	8.3 milliseconds	I^2t	6.60×10^6 A ² sec
	10 milliseconds	I^2t	6.66×10^6 A ² sec
Maximum Rate-of-Rise of On-State Current, (Non-Repetitive)	Per JEDEC Standard 397 5.2.2.6	di/dt	400 A/ μ s
Maximum Rate-of-Rise of On-State Current, (Repetitive)	Per JEDEC Standard 397 5.2.2.6	di/dt	150 A/ μ s
Operating Temperature		T_j	-40 to +125 °C
Storage Temperature		T_{stg}	-40 to +150 °C
Max. Mounting Torque, M6 Mounting Screw			132 in. – Lb.
			15 Nm
Max. Mounting Torque, M10 Terminal Screw			106 in. – Lb.
			12 Nm
Module Weight, Typical			5.33 g
			11.75 lb
V Isolation @ 25C		V_{rms}	3000 V

Information presented is based upon manufacturers testing and projected capabilities.
 This information is subject to change without notice.
 The manufacturer makes no claim as to suitability of use, reliability, capability,
 or future availability of this product.

Electrical Characteristics, T_J=25°C unless otherwise specified

Characteristics	Symbol	Test Conditions	Min.	Max.	Units
Repetitive Peak Forward Leakage Current	I _{DRM}	Up to 1800V, T _J =125°C		100	mA
Repetitive Peak Reverse Leakage Current	I _{RDM}	Up to 1800V, T _J =125°C		100	mA
Peak On-State Voltage	V _{TM}	I _{TM} =3000A, T _J =125°C		1.30	V
Threshold Voltage, Low-level	V _{(TO)1}	T _J = 125°C, I = 15%I _{T(AV)} to πI _{T(AV)}		0.703	V
Slope Resistance, Low-level	r _{T1}			0.184	mΩ
Threshold Voltage, High-level	V _{(TO)2}	T _J = 125°C, I = πI _{T(AV)} to I _{TSM}		1.01	V
Slope Resistance, High-level	r _{T2}			0.117	mΩ
V _{TM} Coefficients, Full Range		T _J = 125°C, I = 50A to 6kA V _{TM} = A + B Ln I + C I + D Sqrt I	A = B = C = D =	0.7999 -4.62 E-02 7.33 E-05 1.10 E-02	
Minimum dV/dt	dV/dt	Exponential to 0.67V _{DRM} T _J =125°C, Gate Open	300		V/μs
Gate Trigger Current	I _{GT}	T _J =25°C, V _D =12V		200	mA
Gate Trigger Voltage	V _{GT}	T _J =25°C, V _D =12V		4.5	Volts
Non-Triggering Gate Voltage	V _{GDM}	T _J =125°C, V _D = ½ V _{DRM}		0.15	Volts
Holding Current	I _H			300	mA
Peak Forward Gate Current	I _{GTM}			4.0	Amp
Peak Reverse Gate Voltage	V _{GRM}			5	Volts
Maximum Average Gate Power Dissipation	P _{GM(AVE)}			16	Watts

Thermal Characteristics

Characteristics	Symbol		Max.	Units
Thermal Resistance, Junction to Case	R _{θJ-C}	Per Module, both conducting	0.029	°C/W
		Per Junction, both conducting	0.058	°C/W
Thermal Impedance Coefficients	Z _{θJ-C}	Z _{θJ-C} = K ₁ (1-exp(-t/τ ₁))	K ₁ = 5.04 E-04	τ ₁ = 2.47 E-03
		+ K ₂ (1-exp(-t/τ ₂))	K ₂ = 2.31 E-03	τ ₂ = 4.42 E-02
		+ K ₃ (1-exp(-t/τ ₃))	K ₃ = 2.83 E-03	τ ₃ = 1.370
		+ K ₄ (1-exp(-t/τ ₄))	K ₄ =5.24 E-02	τ ₄ = 9.668
Thermal Resistance, Case to Sink Lubricated	R _{θC-S}	Per Module	0.009	°C/W

Typical On-State Forward Voltage Drop
(T_j = 125°C)

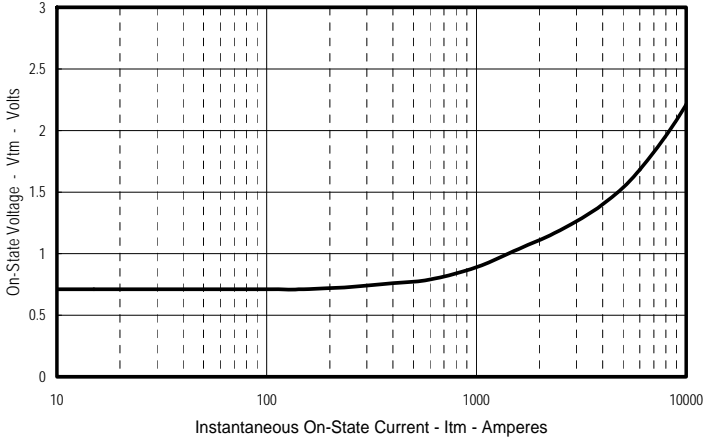

Maximum Transient Thermal Impedance
(Junction To Case)

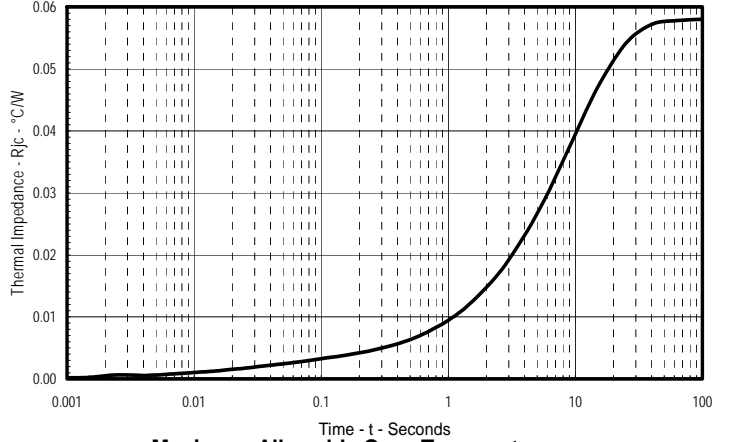

Maximum On-State Power Dissipation
(Sinusoidal Waveform)

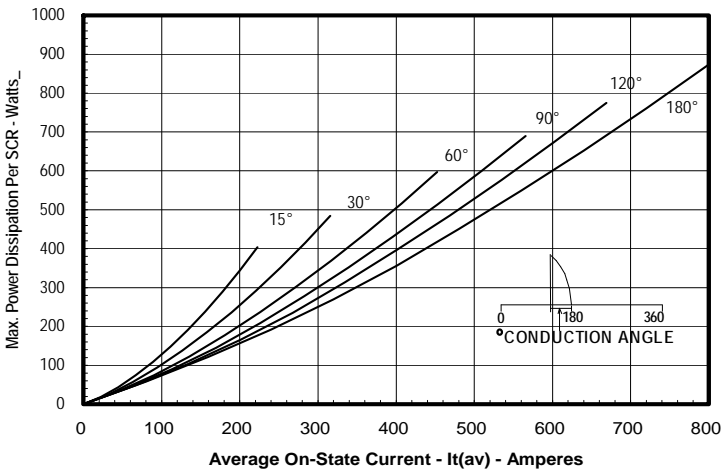

Maximum Allowable Case Temperature
(Sinusoidal Waveform)

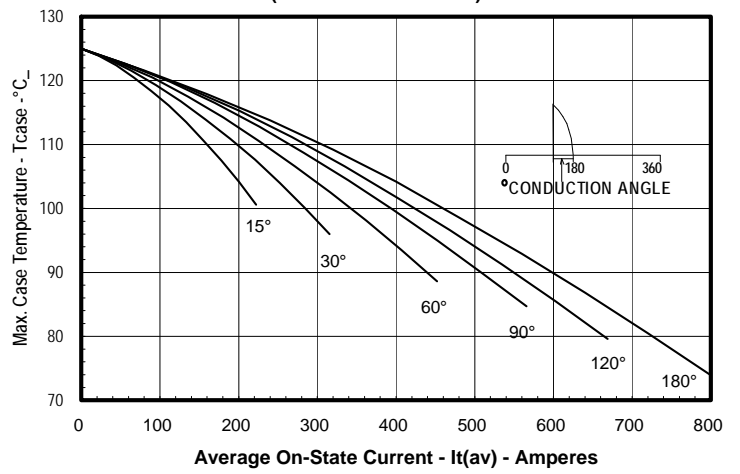

Maximum On-State Power Dissipation
(Rectangular Waveform)

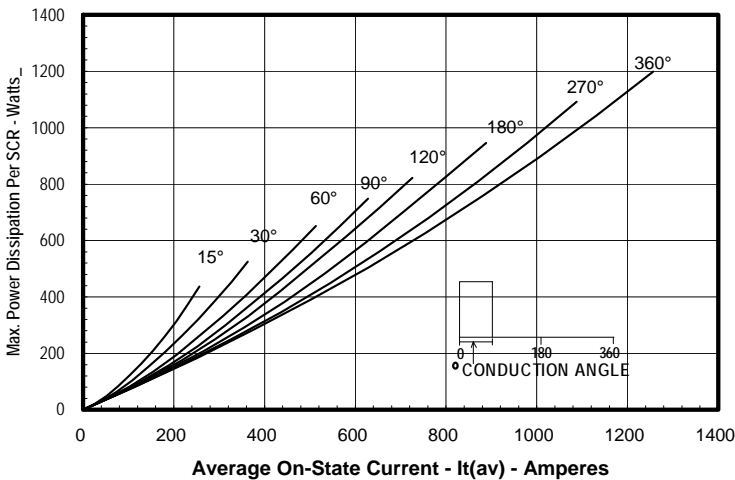

Maximum Allowable Case Temperature
(Rectangular Waveform)

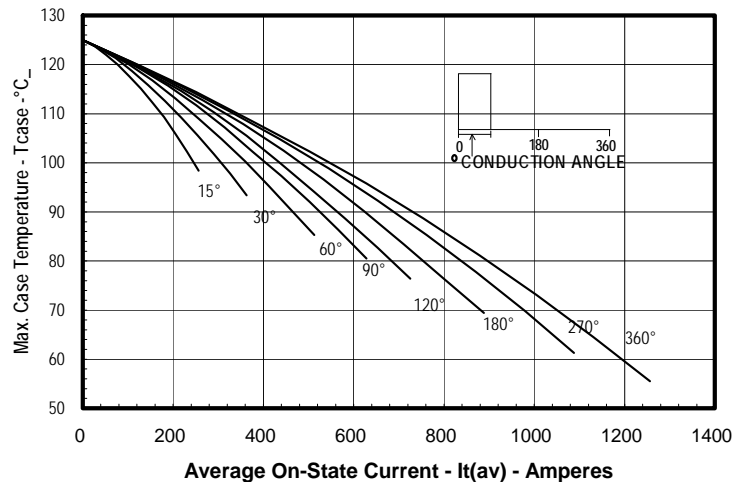

Powerex, Inc., 173 Pavilion Lane, Youngwood, Pennsylvania 15697 (724) 925-7272
www.pwr.com

POW-R-BLOK™ Dual SCR Isolated Module 700 Amperes / Up to 1800 Volts

DIM.	INCHES	MILLIMETERS
A	7.80	198.1
B	4.00	101.6
C	2.68	68.1
D	6.44	163.6
E	3.44	87.4
F	.28	7.1
G	7.31	185.7
H	7.00	177.8
J	1.65	42
K	.21	5.3
L	.28	7.1
M	.281	7.1
N	.45	11.4
P	.54	13.7
Q	5.93	150.6
R	.19	4.8
S	.11	2.8
T	.48	12.2
U	2.28	58
V	2.54	64.5
W	4.93	125.2
X	3.81	96.8
Y	.03	.8
Z	2.00	50.8
AA	1.00	25.4
BB	.50	12.7
CC	1.00	25.4
DD	.406	10.3
EE	2.87	72.9
FF	.66	16.8

