

POW-R-BLOK™ Dual SCR / Diode Isolated Module 700 Amperes, Up to 1800 Volts

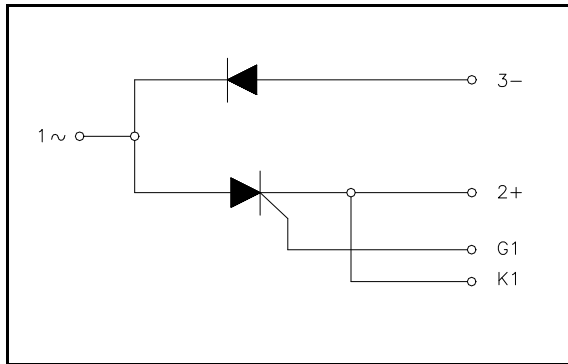

Ordering Information:

Select the complete eight-digit module part number from the table below.

Example: PD421807 is a 1800 Volt, 700A Average SCR/Diode Isolated POW-R-BLOK™ Module

| Type | Voltage Volts (x100) | Current Amperes (x100) |
|------|-------------------------|------------------------------|
| PD42 | 12 | 07 |
| | 14 | |
| | 16 | |
| | 18 | |

Description:

Powerex Dual SCR/Diode Modules are designed for use in applications requiring phase control and isolated packaging. The modules are isolated for easy mounting with other components on a common heatsink.

Features:

- Electrically Isolated Heatsinking
- Compression Bonded Elements
- Metal Baseplate
- Low Thermal Impedance for Improved Current Capability
- UL Recognized (E78240)

Benefits:

- No Additional Insulation Components Required
- Easy Installation
- No Clamping Components Required
- Reduce Engineering Time

Applications:

- Bridge Circuits
- AC & DC Motor Drives
- Motor Soft Starters
- Battery Supplies
- Power Supplies
- Large IGBT Circuit Front Ends

Absolute Maximum Ratings

| Characteristics | Conditions | Symbol | Units | |
|---|---|-----------------------|--------------------|-------------------|
| Repetitive Peak Forward and Reverse Blocking Voltage | | V_{DRM} & V_{RRM} | Up to 1800 | V |
| Non-Repetitive Peak Blocking Voltage ($t < 5$ msec) | | V_{RSM} | $V_{RRM} + 100V$ | V |
| RMS Current AC Switch Configuration (180° Conduction) | 180° Conduction, $T_C=74^\circ C$ | $I_{T(RMS)}$ | 1775 | A |
| | 180° Conduction, $T_C=78^\circ C$ | $I_{T(RMS)}$ | 1665 | A |
| | 180° Conduction, $T_C=82^\circ C$ | $I_{T(RMS)}$ | 1550 | A |
| | 180° Conduction, $T_C=86^\circ C$ | $I_{T(RMS)}$ | 1440 | A |
| RMS Current Per SCR (180° Conduction) | 180° Conduction, $T_C=74^\circ C$ | $I_{T(RMS)}$ | 1256 | A |
| | 180° Conduction, $T_C=78^\circ C$ | $I_{T(RMS)}$ | 1178 | A |
| | 180° Conduction, $T_C=82^\circ C$ | $I_{T(RMS)}$ | 1100 | A |
| | 180° Conduction, $T_C=86^\circ C$ | $I_{T(RMS)}$ | 1020 | A |
| Average Forward Current Per SCR (180° Conduction) | 180° Conduction, $T_C=74^\circ C$ | $I_{T(AV)}$ | 800 | A |
| | 180° Conduction, $T_C=78^\circ C$ | $I_{T(AV)}$ | 750 | A |
| | 180° Conduction, $T_C=82^\circ C$ | $I_{T(AV)}$ | 700 | A |
| | 180° Conduction, $T_C=86^\circ C$ | $I_{T(AV)}$ | 650 | A |
| Peak One Cycle Surge Current, Non-Repetitive $T_j = 25C, V_r = 0$ | 60 Hz | I_{TSM} | 69,000 | A |
| | 50 Hz | I_{TSM} | 63,000 | A |
| Peak One Cycle Surge Current, Non-Repetitive $T_j = 25C, V_r = V_{rrm}$ | 60 Hz | I_{TSM} | 46,000 | A |
| | 50 Hz | I_{TSM} | 42,000 | A |
| Peak One Cycle Surge Current, Non-Repetitive $T_j = 125C, V_r = 0$ | 60 Hz | I_{TSM} | 60,000 | A |
| | 50 Hz | I_{TSM} | 54,750 | A |
| Peak One Cycle Surge Current, Non-Repetitive $T_j = 125C, V_r = V_{rrm}$ | 60 Hz | I_{TSM} | 40,000 | A |
| | 50 Hz | I_{TSM} | 36,500 | A |
| Peak Three Cycle Surge Current, Non-Repetitive | 60 Hz, $T_j = 125C, V_r = V_{rrm}$ | I_{TSM} | 32,100 | A |
| Peak Ten Cycle Surge Current, Non-Repetitive | 60 Hz, $T_j = 125C, V_r = V_{rrm}$ | I_{TSM} | 25,200 | A |
| I^2t for Fusing for One Cycle $T_j = 125C, V_r = V_{rrm}$ | 8.3 milliseconds | I^2t | 6.60×10^6 | $A^2 \text{ sec}$ |
| | 10 milliseconds | I^2t | 6.66×10^6 | $A^2 \text{ sec}$ |
| Maximum Rate-of-Rise of On-State Current, (Non-Repetitive) | Per JEDEC Standard 397 5.2.2.6 | di/dt | 400 | $A/\mu s$ |
| Maximum Rate-of-Rise of On-State Current, (Repetitive) | Per JEDEC Standard 397 5.2.2.6 | di/dt | 150 | $A/\mu s$ |
| Operating Temperature | | T_J | -40 to +125 | $^\circ C$ |
| Storage Temperature | | T_{stg} | -40 to +150 | $^\circ C$ |
| Max. Mounting Torque, M6 Mounting Screw | | | 132 | in. – Lb. |
| | | | 15 | Nm |
| Max. Mounting Torque, M10 Terminal Screw | | | 106 | in. – Lb. |
| | | | 12 | Nm |
| Module Weight, Typical | | | 5.33 | kg |
| | | | 11.75 | lb |
| V Isolation @ 25C | | V_{rms} | 3000 | V |

Information presented is based upon manufacturers testing and projected capabilities.
 This information is subject to change without notice.
 The manufacturer makes no claim as to suitability for use, reliability, capability,
 or future availability of this product.

Electrical Characteristics, T_J=25°C unless otherwise specified

| Characteristics | Symbol | Test Conditions | Min. | Max. | Units |
|--|-----------------------|---|--------------------------|--|-------|
| Repetitive Peak Forward Leakage Current | I _{DRM} | Up to 1800V, T _J =125°C | | 100 | mA |
| Repetitive Peak Reverse Leakage Current | I _{RDM} | Up to 1800V, T _J =125°C | | 100 | mA |
| Peak On-State Voltage | V _{TM} | I _{TM} =3000A, T _J =125°C | | 1.30 | V |
| Threshold Voltage, Low-level | V _{(TO)1} | T _J = 125°C, I = 15%I _{T(AV)} to πI _{T(AV)} | | 0.703 | V |
| Slope Resistance, Low-level | r _{T1} | | | 0.184 | mΩ |
| Threshold Voltage, High-level | V _{(TO)2} | T _J = 125°C, I = πI _{T(AV)} to I _{TSM} | | 1.01 | V |
| Slope Resistance, High-level | r _{T2} | | | 0.117 | mΩ |
| V _{TM} Coefficients, Full Range | | T _J = 125°C, I = 50A to 6kA V _{TM} = A+ B Ln I +C I + D Sqrt I | A = B = C = D = | 0.7999 -4.62 E-02 7.33 E-05 1.10 E-02 | |
| Minimum dV/dt | dV/dt | Exponential to 0.67V _{DRM} T _J =125°C, Gate Open | 300 | | V/μs |
| Typical Diode Reverse Recovery Time | T _{RR} | T _J =25°C, I _F =1500A, dI _R /dt = 25A/μs, T _P = 190 μs | 22 Typ. | | μs |
| Gate Trigger Current | I _{GT} | T _J =25°C, V _D =12V | | 200 | mA |
| Gate Trigger Voltage | V _{GT} | T _J =25°C, V _D =12V | | 4.5 | Volts |
| Non-Triggering Gate Voltage | V _{GDM} | T _J =125°C, V _D = ½ V _{DRM} | | 0.15 | Volts |
| Holding Current | I _H | | | 300 | mA |
| Peak Forward Gate Current | I _{GTM} | | | 4.0 | Amp |
| Peak Reverse Gate Voltage | V _{GRM} | | | 5 | Volts |
| Maximum Average Gate Power Dissipation | P _{GM (AVE)} | | | 16 | Watts |

Thermal Characteristics

| Characteristics | Symbol | | Max. | Units |
|---|-------------------|--|---|--|
| Thermal Resistance, Junction to Case | R _{ΘJ-C} | Per Module, both conducting | 0.029 | °C/W |
| | | Per Junction, both conducting | 0.058 | °C/W |
| Thermal Impedance Coefficients | Z _{ΘJ-C} | Z _{ΘJ-C} = K ₁ (1-exp(-t/τ ₁)) + K ₂ (1-exp(-t/τ ₂)) + K ₃ (1-exp(-t/τ ₃)) + K ₄ (1-exp(-t/τ ₄)) | K ₁ = 5.04 E-04 K ₂ = 2.31 E-03 K ₃ = 2.83 E-03 K ₄ =5.24 E-02 | τ ₁ = 2.47 E-03 τ ₂ = 4.42 E-02 τ ₃ = 1.370 τ ₄ = 9.668 |
| Thermal Resistance, Case to Sink Lubricated | R _{ΘC-S} | Per Module | 0.009 | °C/W |

Typical On-State Forward Voltage Drop
($T_j = 125^\circ\text{C}$)

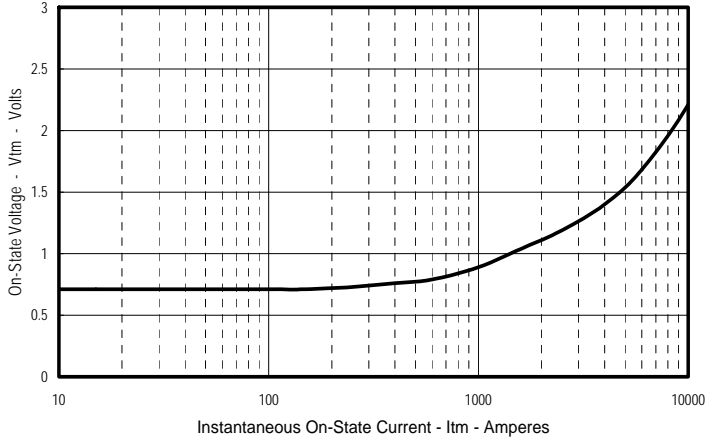

Maximum Transient Thermal Impedance
(Junction To Case)

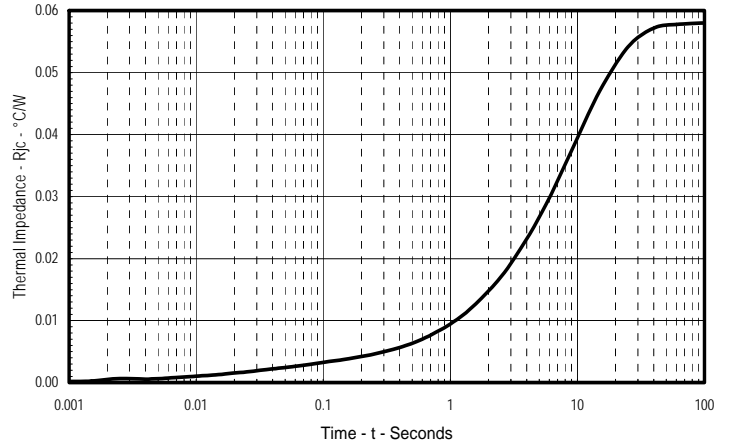

Maximum On-State Power Dissipation
(Sinusoidal Waveform)

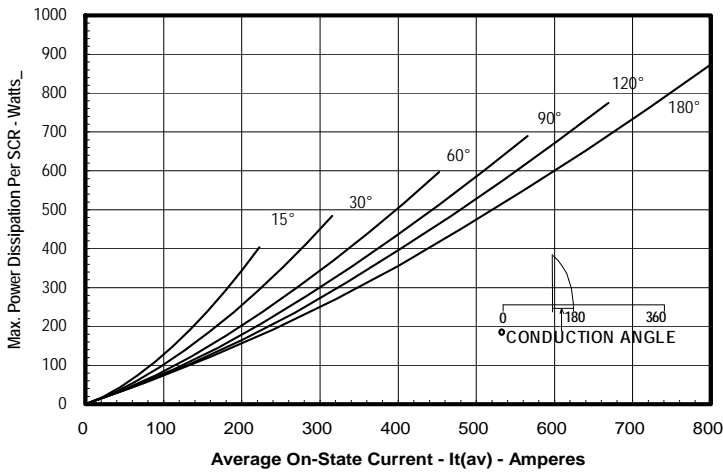

Maximum Allowable Case Temperature
(Sinusoidal Waveform)

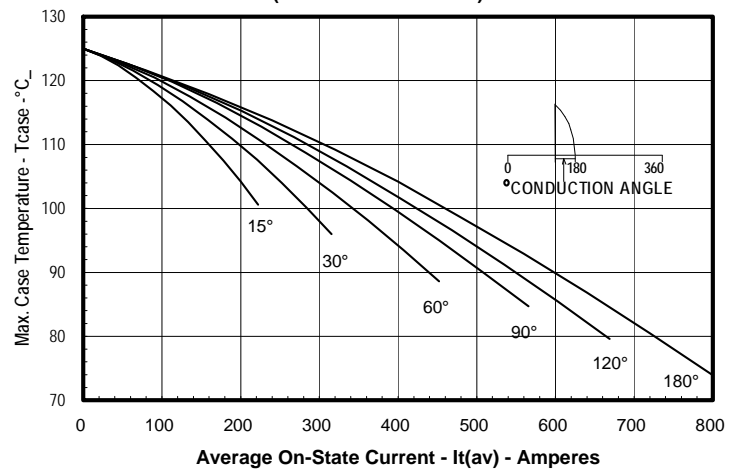

Maximum On-State Power Dissipation
(Rectangular Waveform)

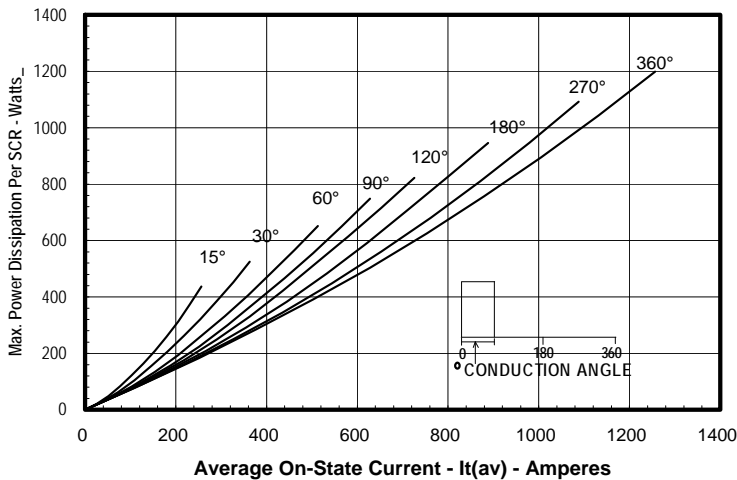

Maximum Allowable Case Temperature
(Rectangular Waveform)

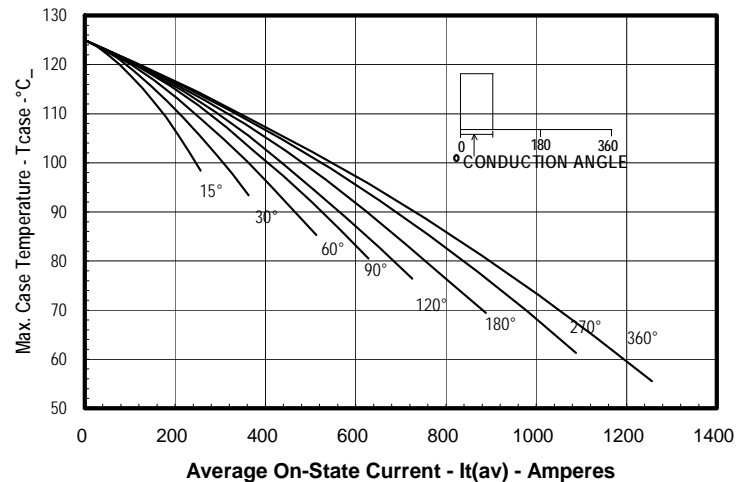

POW-R-BLOK™
Dual SCR / Diode Isolated Module
700 Amperes, Up to 1800 Volts

| DIM. | INCHES | MILLIMETERS |
|------|--------|-------------|
| A | 7.80 | 198.1 |
| B | 4.00 | 101.6 |
| C | 2.68 | 68.1 |
| D | 6.44 | 163.6 |
| E | 3.44 | 87.4 |
| F | .28 | 7.1 |
| G | 7.31 | 185.7 |
| H | 7.00 | 177.8 |
| J | 1.65 | 42 |
| K | .21 | 5.3 |
| L | .28 | 7.1 |
| M | .281 | 7.1 |
| N | .45 | 11.4 |
| P | .54 | 13.7 |
| Q | 5.93 | 150.6 |
| R | .19 | 4.8 |
| S | .11 | 2.8 |
| T | .48 | 12.2 |
| U | 2.28 | 58 |
| V | 2.54 | 64.5 |
| W | 4.93 | 125.2 |
| X | 3.81 | 96.8 |
| Y | .03 | .8 |
| Z | 2.00 | 50.8 |
| AA | 1.00 | 25.4 |
| BB | .50 | 12.7 |
| CC | 1.00 | 25.4 |
| DD | .406 | 10.3 |
| EE | 2.87 | 72.9 |
| FF | .66 | 16.8 |

