

POW-R-BLOK™
Dual Diode Isolated Module
1000 Amperes / Up to 4000 Volts

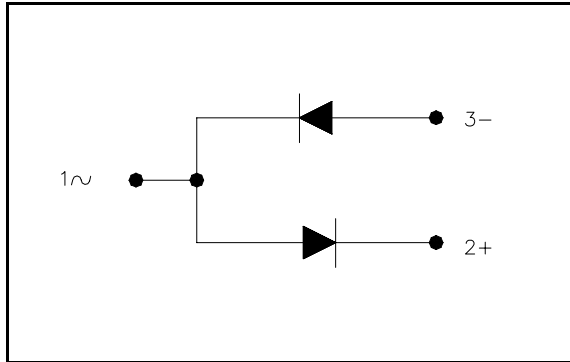

Ordering Information:

Select the complete eight-digit module part number from the table below.

Example: PD414010 is a 4000 Volt, 1000A Average Dual Diode Isolated POW-R-BLOK™ Module

| Type | Voltage Volts (x100) | Current Amperes (x100) |
|------|-------------------------|------------------------------|
| PD41 | 36 | 10 |
| | 38 | |
| | 40 | |

Description:

Powerex Dual Diode Modules are designed for use in applications requiring rectification and isolated packaging. The modules are isolated for easy mounting with other components on a common heatsink.

Features:

- Electrically Isolated Heatsinking
- Compression Bonded Elements
- Metal Baseplate
- Low Thermal Impedance for Improved Current Capability

Benefits:

- No Additional Insulation Components Required
- Easy Installation
- No Clamping Components Required
- Reduce Engineering Time

Applications:

- Bridge Circuits
- AC & DC Motor Drives
- Battery Supplies
- Power Supplies
- Large IGBT Circuit Front Ends

Absolute Maximum Ratings

| Characteristics | Conditions | Symbol | Units | |
|---|---|--------------|--------------------|-------------------|
| Repetitive Peak Reverse Blocking Voltage | | V_{RRM} | Up to 4000 | V |
| Non-Repetitive Peak Blocking Voltage ($t < 5$ msec) | | V_{RSM} | $V_{RRM} + 100V$ | V |
| RMS Current Per Diode (180° Conduction) | 180° Conduction, $T_C=79^\circ C$ | $I_{F(RMS)}$ | 1725 | A |
| | 180° Conduction, $T_C=87^\circ C$ | $I_{F(RMS)}$ | 1570 | A |
| | 180° Conduction, $T_C=95^\circ C$ | $I_{F(RMS)}$ | 1415 | A |
| | 180° Conduction, $T_C=103^\circ C$ | $I_{F(RMS)}$ | 1255 | A |
| Average Forward Current Per Diode (180° Conduction) | 180° Conduction, $T_C=79^\circ C$ | $I_{F(AV)}$ | 1100 | A |
| | 180° Conduction, $T_C=87^\circ C$ | $I_{F(AV)}$ | 1000 | A |
| | 180° Conduction, $T_C=95^\circ C$ | $I_{F(AV)}$ | 900 | A |
| | 180° Conduction, $T_C=103^\circ C$ | $I_{F(AV)}$ | 800 | A |
| Peak One Cycle Surge Current, Non-Repetitive $T_j = 25C, V_r = 0$ | 60 Hz | I_{FSM} | 48,300 | A |
| | 50 Hz | I_{FSM} | 41,060 | A |
| Peak One Cycle Surge Current, Non-Repetitive $T_j = 25C, V_r = V_{rrm}$ | 60 Hz | I_{FSM} | 32,200 | A |
| | 50 Hz | I_{FSM} | 27,375 | A |
| Peak One Cycle Surge Current, Non-Repetitive $T_j = 125C, V_r = 0$ | 60 Hz | I_{FSM} | 42,000 | A |
| | 50 Hz | I_{FSM} | 35,700 | A |
| Peak One Cycle Surge Current, Non-Repetitive $T_j = 125C, V_r = V_{rrm}$ | 60 Hz | I_{FSM} | 28,000 | A |
| | 50 Hz | I_{FSM} | 23,800 | A |
| Peak Three Cycle Surge Current, Non-Repetitive | 60 Hz, $T_j = 125C, V_r = V_{rrm}$ | I_{FSM} | 22,480 | A |
| Peak Ten Cycle Surge Current, Non-Repetitive | 60 Hz, $T_j = 125C, V_r = V_{rrm}$ | I_{FSM} | 17,660 | A |
| I^2t for Fusing for One Cycle $T_j = 125C, V_r = V_{rrm}$ | 8.3 milliseconds | I^2t | 3.26×10^6 | $A^2 \text{ sec}$ |
| | 10 milliseconds | I^2t | 2.83×10^6 | $A^2 \text{ sec}$ |
| I^2t for Fusing for One Cycle $T_j = 25C, V_r = 0$ | 8.3 milliseconds | I^2t | 9.72×10^6 | $A^2 \text{ sec}$ |
| | 10 milliseconds | I^2t | 8.43×10^6 | $A^2 \text{ sec}$ |
| Operating Temperature | | T_J | -40 to +150 | °C |
| Storage Temperature | | T_{stg} | -40 to +150 | °C |
| Max. Mounting Torque, M6 Mounting Screw | | | 132 | in. – Lb. |
| | | | 15 | Nm |
| Max. Mounting Torque, M10 Terminal Screw | | | 106 | in. – Lb. |
| | | | 12 | Nm |
| Module Weight, Typical | | | 5.33 | kg |
| | | | 11.75 | lb |
| V Isolation @ 25C | 60Hz V_{rms} 60 sec | V_{rms} | 3600 | V |

Information presented is based upon manufacturers testing and projected capabilities.
 This information is subject to change without notice.
 The manufacturer makes no claim as to suitability for use, reliability, capability,
 or future availability of this product.

Electrical Characteristics, T_J=25°C unless otherwise specified

| Characteristics | Symbol | Test Conditions | Min. | Max. | Units |
|--|--------------------|---|--------------------------|--|-------|
| Repetitive Peak Reverse Leakage Current | I _{RRM} | Up to 4000V, T _J =125°C | | 200 | mA |
| Peak On-State Voltage | V _{FM} | I _{FM} =3000A, T _J =25°C | | 1.35 | V |
| Threshold Voltage, Low-level | V _{(TO)1} | T _J = 125°C, I = 15%I _{T(AV)} to πI _{T(AV)} | | 0.741 | V |
| Slope Resistance, Low-level | r _{T1} | | | 0.132 | mΩ |
| Threshold Voltage, High-level | V _{(TO)2} | T _J = 125°C, I = πI _{T(AV)} to I _{TSM} | | 0.840 | V |
| Slope Resistance, High-level | r _{T2} | | | 0.119 | mΩ |
| V _{FM} Coefficients, Full Range | | T _J = 125°C, I = 50A to 6kA V _{FM} = A+ B Ln I +C I + D Sqrt I | A = B = C = D = | 0.7903 -1.11 E-02 1.27 E-04 1.01 E-03 | |
| Typical Reverse Recovery Time | t _{rr} | T _J = 25°C, I _{fm} = 1500A. di _r /dt = 25 A/us, t _p = 190 us | | 25 | us |

Thermal Characteristics

| Characteristics | Symbol | | Max. | Units |
|---|-------------------|--|---|--|
| Thermal Resistance, Junction to Case | R _{θJ-C} | Per Module, both conducting | 0.029 | °C/W |
| | | Per Junction, both conducting | 0.058 | °C/W |
| Thermal Impedance Coefficients | Z _{θJ-C} | Z _{θJ-C} = K ₁ (1-exp(-t/τ ₁)) + K ₂ (1-exp(-t/τ ₂)) + K ₃ (1-exp(-t/τ ₃)) + K ₄ (1-exp(-t/τ ₄)) | K ₁ = 5.04 E-04 K ₂ = 2.31 E-03 K ₃ = 2.83 E-03 K ₄ =5.24 E-02 | τ ₁ = 2.47 E-03 τ ₂ = 4.42 E-02 τ ₃ = 1.370 τ ₄ = 9.668 |
| Thermal Resistance, Case to Sink Lubricated | R _{θC-S} | Per Module | 0.009 | °C/W |

Typical On-State Forward Voltage Drop
(T_J = 150C)

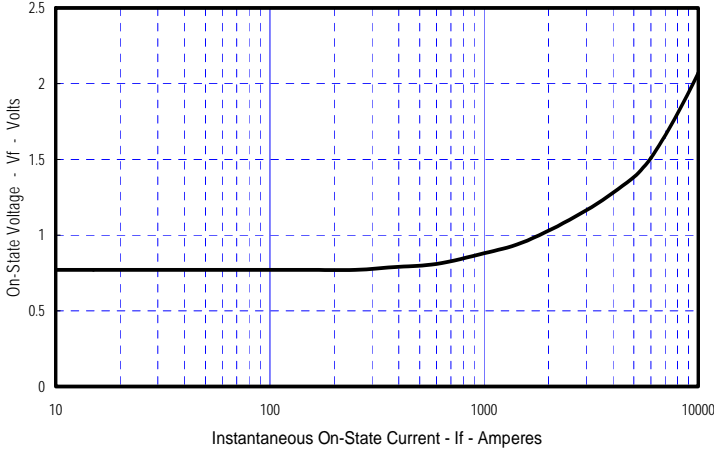

Maximum Transient Thermal Impedance
(Junction To Case)

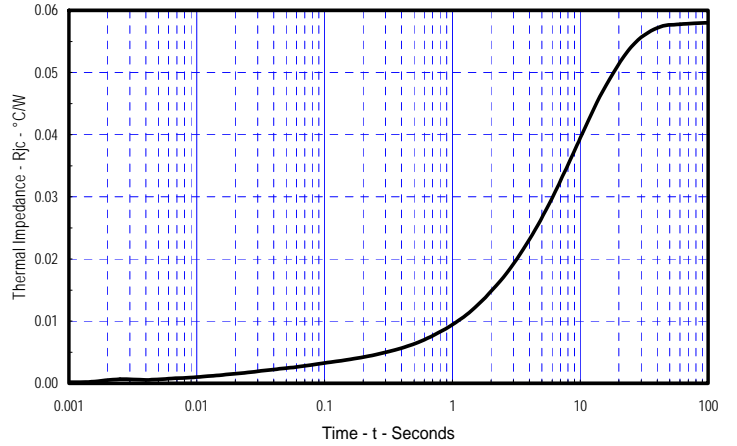

Maximum On-State Power Dissipation
(Sinusoidal Waveform)

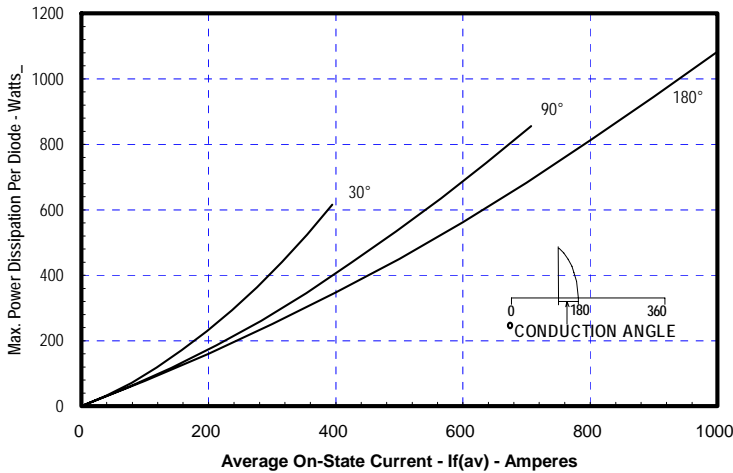

Maximum Allowable Case Temperature
(Sinusoidal Waveform)

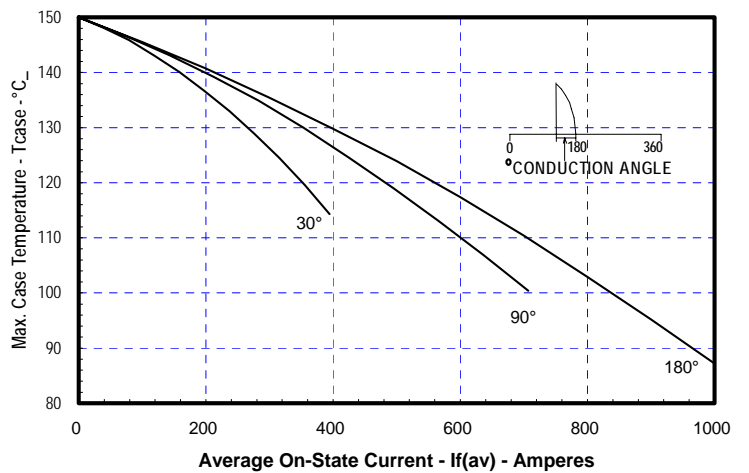

Maximum On-State Power Dissipation
(Rectangular Waveform)

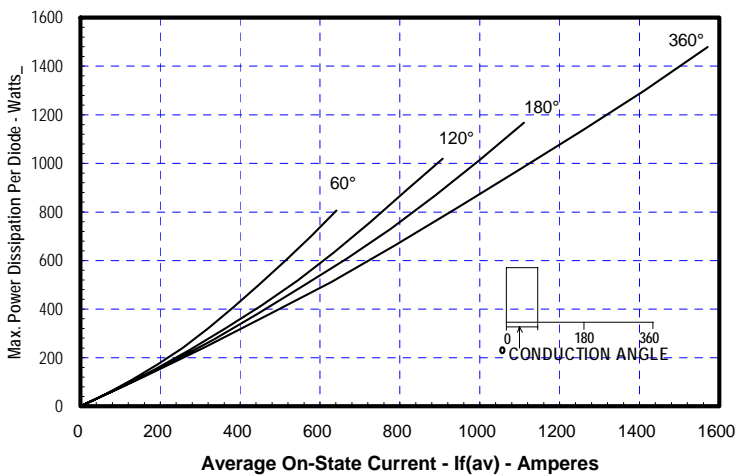

Maximum Allowable Case Temperature
(Rectangular Waveform)

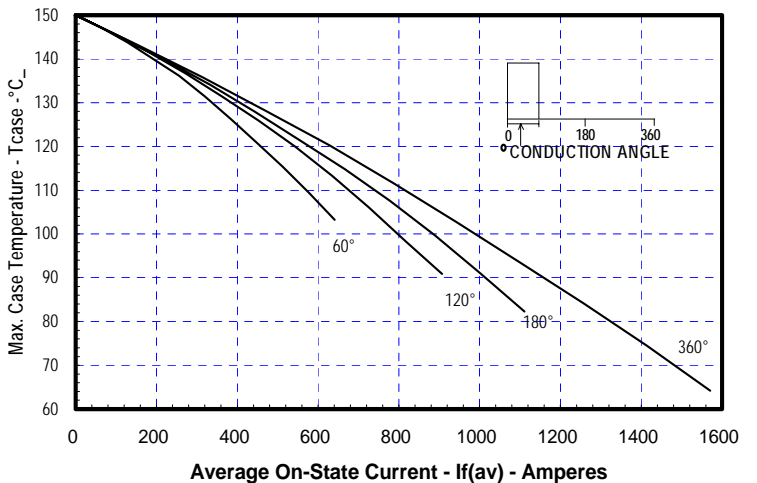

| DIM. | INCHES | MILLIMETERS |
|------|--------|-------------|
| A | 7.80 | 198.1 |
| B | 4.00 | 101.6 |
| C | 2.68 | 68.1 |
| D | 6.44 | 163.6 |
| E | 3.44 | 87.4 |
| F | .28 | 7.1 |
| G | 7.31 | 185.7 |
| H | 7.00 | 177.8 |
| M | .281 | 7.1 |
| N | .45 | 11.4 |
| P | .54 | 13.7 |
| Q | 5.93 | 150.6 |
| R | .19 | 4.8 |
| T | .48 | 12.2 |
| U | 2.28 | 58 |
| W | 4.93 | 125.2 |
| X | 3.81 | 96.8 |
| Z | 2.00 | 50.8 |
| AA | 1.00 | 25.4 |
| BB | .50 | 12.7 |
| CC | 1.00 | 25.4 |
| DD | .406 | 10.3 |
| EE | 2.87 | 72.9 |
| FF | .66 | 16.8 |

