

**POW-R-BLOK™**  
**Dual Diode Isolated Module**  
**1100 Amperes / Up to 2400 Volts**

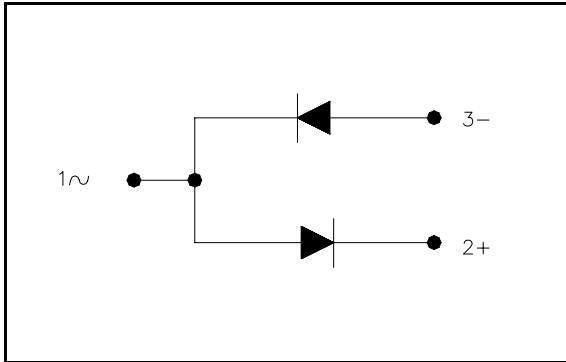

**Ordering Information:**

Select the complete eight-digit module part number from the table below.

Example: PD412411 is a 2400 Volt, 1100A Average Dual Diode Isolated POW-R-BLOK™ Module

Type	Voltage Volts (x100)	Current Amperes (x100)
PD41	18	11
	20	
	22	
	24	

**Description:**

Powerex Dual Diode Modules are designed for use in applications requiring rectification and isolated packaging. The modules are isolated for easy mounting with other components on a common heatsink.

**Features:**

- Electrically Isolated Heatsinking
- Compression Bonded Elements
- Metal Baseplate
- Low Thermal Impedance for Improved Current Capability
- UL Recognized (E78240)

**Benefits:**

- No Additional Insulation Components Required
- Easy Installation
- No Clamping Components Required
- Reduce Engineering Time

**Applications:**

- Bridge Circuits
- AC & DC Motor Drives
- Battery Supplies
- Power Supplies
- Large IGBT Circuit Front Ends

**Absolute Maximum Ratings**

Characteristics	Conditions	Symbol		Units
Repetitive Peak Reverse Blocking Voltage		$V_{RRM}$	Up to 2400	V
Non-Repetitive Peak Blocking Voltage ( $t < 5$ msec)		$V_{RSM}$	$V_{RRM} + 100V$	V
RMS Current Per Diode (180° Conduction)	180° Conduction, $T_C=80^\circ C$	$I_{F(RMS)}$	1885	A
	<b>180° Conduction, <math>T_C=87^\circ C</math></b>	$I_{F(RMS)}$	<b>1725</b>	A
	180° Conduction, $T_C=95^\circ C$	$I_{F(RMS)}$	1570	A
	180° Conduction, $T_C=98^\circ C$	$I_{F(RMS)}$	1415	A
Average Forward Current Per Diode (180° Conduction)	180° Conduction, $T_C=80^\circ C$	$I_{F(AV)}$	1200	A
	<b>180° Conduction, <math>T_C=87^\circ C</math></b>	$I_{F(AV)}$	<b>1100</b>	A
	180° Conduction, $T_C=95^\circ C$	$I_{F(AV)}$	1000	A
	180° Conduction, $T_C=98^\circ C$	$I_{F(AV)}$	900	A
Peak One Cycle Surge Current, Non-Repetitive $T_j = 25C, V_r = 0$	60 Hz	$I_{FSM}$	50,890	A
	50 Hz	$I_{FSM}$	46,400	A
Peak One Cycle Surge Current, Non-Repetitive $T_j = 25C, V_r = V_{rrm}$	60 Hz	$I_{FSM}$	33,925	A
	50 Hz	$I_{FSM}$	30,935	A
Peak One Cycle Surge Current, Non-Repetitive $T_j = 125C, V_r = 0$	60 Hz	$I_{FSM}$	44,250	A
	50 Hz	$I_{FSM}$	40,350	A
Peak One Cycle Surge Current, Non-Repetitive $T_j = 125C, V_r = V_{rrm}$	60 Hz	$I_{FSM}$	29,500	A
	50 Hz	$I_{FSM}$	26,900	A
Peak Three Cycle Surge Current, Non-Repetitive	60 Hz, $T_j = 125C, V_r = V_{rrm}$	$I_{FSM}$	23,690	A
Peak Ten Cycle Surge Current, Non-Repetitive	60 Hz, $T_j = 125C, V_r = V_{rrm}$	$I_{FSM}$	18,615	A
$I^2t$ for Fusing for One Cycle $T_j = 125C, V_r = V_{rrm}$	8.3 milliseconds	$I^2t$	$3.63 \times 10^6$	$A^2 \text{ sec}$
	10 milliseconds	$I^2t$	$3.62 \times 10^6$	$A^2 \text{ sec}$
Operating Temperature		$T_J$	-40 to +150	$^\circ C$
Storage Temperature		$T_{stg}$	-40 to +150	$^\circ C$
Max. Mounting Torque, M6 Mounting Screw			132	in. – Lb.
			15	Nm
Max. Mounting Torque, M10 Terminal Screw			106	in. – Lb.
			12	Nm
Module Weight, Typical			5.33	kg
			11.75	lb
V Isolation @ 25C		$V_{rms}$	3000	V

Information is based upon manufacturers testing and projected capabilities.  
 This information is subject to change without notice.  
 The manufacturer makes no claim as to suitability for use, reliability, capability,  
 or future availability of this product.

**Electrical Characteristics, T<sub>J</sub>=25°C unless otherwise specified**

Characteristics	Symbol	Test Conditions	Min.	Max.	Units
Repetitive Peak Reverse Leakage Current	I <sub>RRM</sub>	Up to 2400V, T <sub>J</sub> =125°C		200	mA
Peak On-State Voltage	V <sub>FM</sub>	I <sub>FM</sub> =3000A, T <sub>J</sub> =25°C		1.25	V
Threshold Voltage, Low-level	V <sub>(TO)1</sub>	T <sub>J</sub> = 125°C, I = 15%I <sub>T(AV)</sub> to πI <sub>T(AV)</sub>		0.663	V
Slope Resistance, Low-level	r <sub>T1</sub>			0.113	mΩ
Threshold Voltage, High-level	V <sub>(TO)2</sub>	T <sub>J</sub> = 125°C, I = πI <sub>T(AV)</sub> to I <sub>TSM</sub>		.642	V
Slope Resistance, High-level	r <sub>T2</sub>			0.116	mΩ
V <sub>FM</sub> Coefficients, Full Range		T <sub>J</sub> = 125°C, I = 50A to 6kA V <sub>FM</sub> = A+ B Ln I +C I + D Sqrt I	A = B = C = D =	0.6418 1.08 E-02 1.18 E-04 -1.57 E-03	
Typical Reverse Recovery Time	t <sub>rr</sub>	T <sub>J</sub> = 25°C, I <sub>fm</sub> = 1500A. di <sub>r</sub> /dt = 25 A/us, t <sub>p</sub> = 190 us		22	us

**Thermal Characteristics**

Characteristics	Symbol		Max.	Units
Thermal Resistance, Junction to Case	R <sub>θJ-C</sub>	Per Module, both conducting Per Junction, both conducting	0.029 0.058	°C/W °C/W
Thermal Impedance Coefficients	Z <sub>θJ-C</sub>	Z <sub>θJ-C</sub> = K <sub>1</sub> (1-exp(-t/t <sub>1</sub> )) + K <sub>2</sub> (1-exp(-t/t <sub>2</sub> )) + K <sub>3</sub> (1-exp(-t/t <sub>3</sub> )) + K <sub>4</sub> (1-exp(-t/t <sub>4</sub> ))	K <sub>1</sub> = 5.04 E-04 K <sub>2</sub> = 2.31 E-03 K <sub>3</sub> = 2.83 E-03 K <sub>4</sub> =5.24 E-02	t <sub>1</sub> = 2.47 E-03 t <sub>2</sub> = 4.42 E-02 t <sub>3</sub> = 1.370 t <sub>4</sub> = 9.668
Thermal Resistance, Case to Sink Lubricated	R <sub>θC-S</sub>	Per Module	0.009	°C/W

Typical On-State Forward Voltage Drop  
(T<sub>j</sub> = 150C)

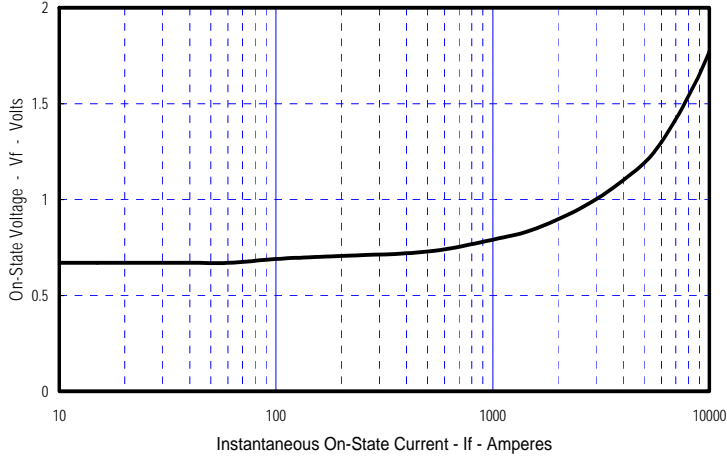

Maximum Transient Thermal Impedance  
(Junction To Case)

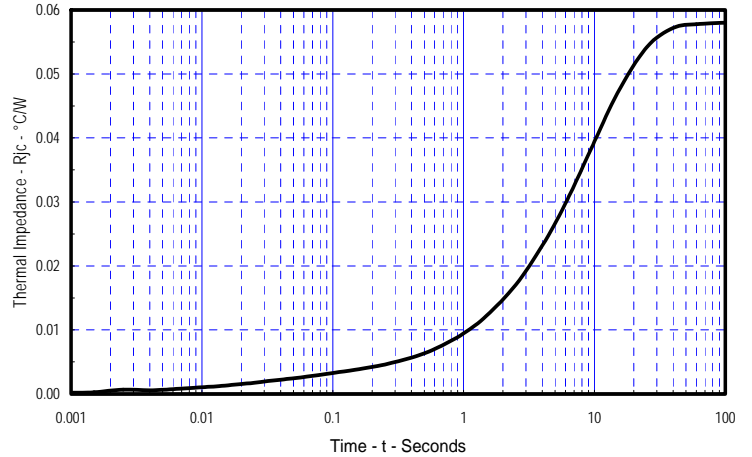

Maximum On-State Power Dissipation  
(Sinusoidal Waveform)

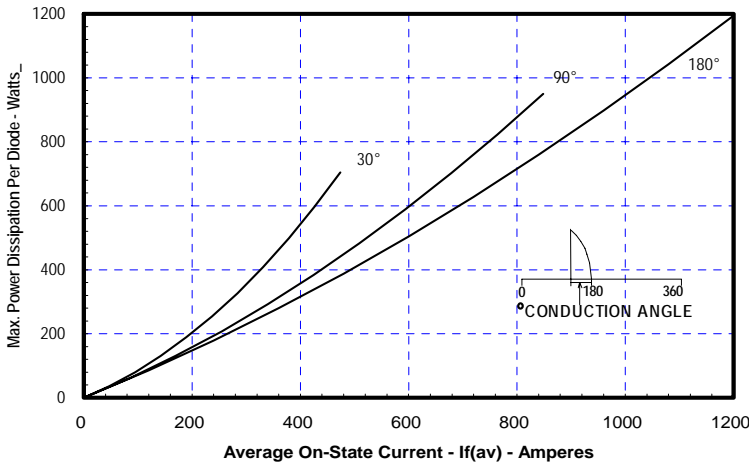

Maximum Allowable Case Temperature  
(Sinusoidal Waveform)

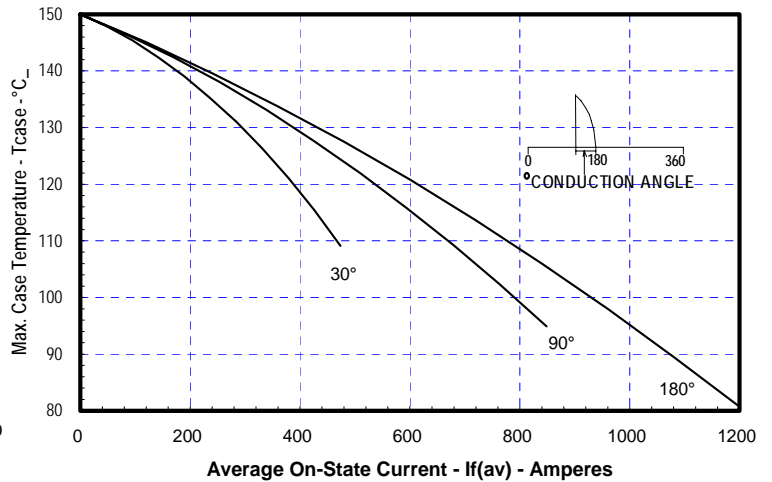

Maximum On-State Power Dissipation  
(Rectangular Waveform)

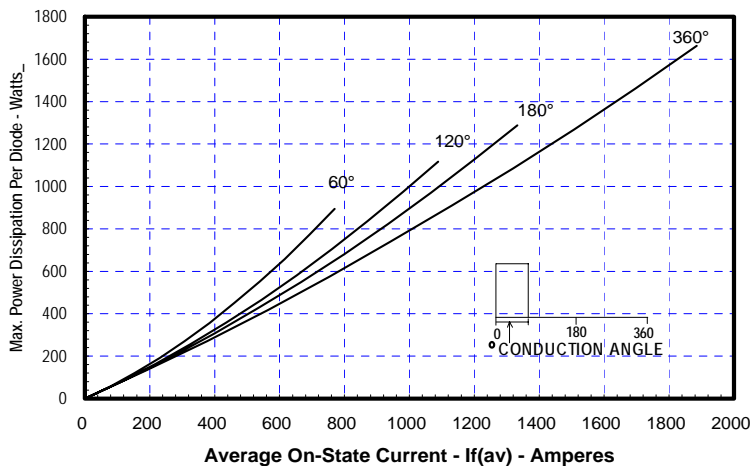

Maximum Allowable Case Temperature  
(Rectangular Waveform)

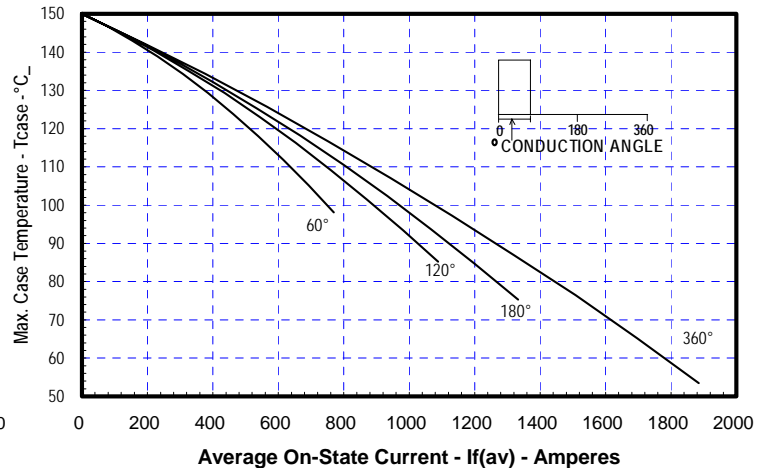

**POW-R-BLOK™**  
**Dual Diode Isolated Module**  
**1100 Amperes / Up to 2400 Volts**

DIM.	INCHES	MILLIMETERS
A	7.80	198.1
B	4.00	101.6
C	2.68	68.1
D	6.44	163.6
E	3.44	87.4
F	.28	7.1
G	7.31	185.7
H	7.00	177.8
M	.281	7.1
N	.45	11.4
P	.54	13.7
Q	5.93	150.6
R	.19	4.8
T	.48	12.2
U	2.28	58
W	4.93	125.2
X	3.81	96.8
Z	2.00	50.8
AA	1.00	25.4
BB	.50	12.7
CC	1.00	25.4
DD	.406	10.3
EE	2.87	72.9
FF	.66	16.8

