

POW-R-BLOK™
AC Switch SCR Isolated Module
1550 Amps RMS, Up to 1800 Volts

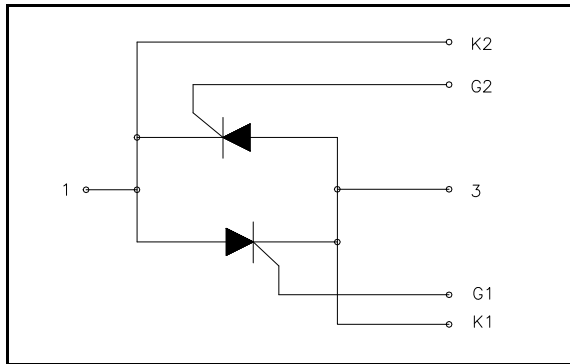

Ordering Information:

Select the complete eight-digit module part number from the table below.

Example: PA431807 is a 1800 Volt, 700A Average/SCR (1550 Ampere RMS/Switch) SCR AC Switch Isolated POW-R-BLOK™ Module

Type	Voltage Volts (x100)	Current Amperes (x100)
PA43	12	07
	14	Average
	16	Current
	18	Per SCR

Description:

Powerex AC Switch SCR Modules are designed for use in applications requiring phase control and isolated packaging. The modules are isolated for easy mounting with other components on a common heatsink.

Features:

- Electrically Isolated Heatsinking
- Compression Bonded Elements
- Metal Baseplate
- Low Thermal Impedance for Improved Current Capability
- UL Recognized (E78240)

Benefits:

- No Additional Insulation Components Required
- Easy Installation
- No Clamping Components Required
- Reduce Engineering Time

Applications:

- Transfer Switches
- AC Welders
- Motor Soft Starters

Absolute Maximum Ratings

Characteristics	Conditions	Symbol	Units	
Repetitive Peak Forward and Reverse Blocking Voltage		V_{DRM} & V_{RRM}	1800	V
Non-Repetitive Peak Blocking Voltage ($t < 5$ msec)		V_{RSM}	1900	V
RMS Current (AC Switch, 180° Conduction)	180° Conduction, $T_C=74^\circ\text{C}$	$I_{T(RMS)}$	1775	A
	180° Conduction, $T_C=78^\circ\text{C}$	$I_{T(RMS)}$	1665	A
	180° Conduction, $T_C=82^\circ\text{C}$	$I_{T(RMS)}$	1550	A
	180° Conduction, $T_C=86^\circ\text{C}$	$I_{T(RMS)}$	1440	A
Average Forward Current Per SCR (180° Conduction)	180° Conduction, $T_C=74^\circ\text{C}$	$I_{T(AV)}$	800	A
	180° Conduction, $T_C=78^\circ\text{C}$	$I_{T(AV)}$	750	A
	180° Conduction, $T_C=82^\circ\text{C}$	$I_{T(AV)}$	700	A
	180° Conduction, $T_C=86^\circ\text{C}$	$I_{T(AV)}$	650	A
Peak One Cycle Surge Current, Non-Repetitive $T_j = 25\text{C}$, $V_r = 0$	60 Hz	I_{TSM}	69,000	A
	50 Hz	I_{TSM}	63,000	A
Peak One Cycle Surge Current, Non-Repetitive $T_j = 25\text{C}$, $V_r = V_{rrm}$	60 Hz	I_{TSM}	46,000	A
	50 Hz	I_{TSM}	42,000	A
Peak One Cycle Surge Current, Non-Repetitive $T_j = 125\text{C}$, $V_r = 0$	60 Hz	I_{TSM}	60,000	A
	50 Hz	I_{TSM}	54,750	A
Peak One Cycle Surge Current, Non-Repetitive $T_j = 125\text{C}$, $V_r = V_{rrm}$	60 Hz	I_{TSM}	40,000	A
	50 Hz	I_{TSM}	36,500	A
Peak Three Cycle Surge Current, Non-Repetitive	60 Hz, $T_j = 125\text{C}$, $V_r = V_{rrm}$	I_{TSM}	32,100	A
Peak Ten Cycle Surge Current, Non-Repetitive	60 Hz, $T_j = 125\text{C}$, $V_r = V_{rrm}$	I_{TSM}	25,200	A
I^2t for Fusing for One Cycle $T_j = 125\text{C}$, $V_r = V_{rrm}$	8.3 milliseconds	I^2t	6.60×10^6	$\text{A}^2 \text{sec}$
	10 milliseconds	I^2t	6.66×10^6	$\text{A}^2 \text{sec}$
Maximum Rate-of-Rise of On-State Current, (Non-Repetitive)	Per JEDEC Standard 397 5.2.2.6	di/dt	400	$\text{A}/\mu\text{s}$
Maximum Rate-of-Rise of On-State Current, (Repetitive)	Per JEDEC Standard 397 5.2.2.6	di/dt	150	$\text{A}/\mu\text{s}$
Operating Temperature		T_j	-40 to +125	$^\circ\text{C}$
Storage Temperature		T_{stg}	-40 to +150	$^\circ\text{C}$
Max. Mounting Torque, M6 Mounting Screw			132	in. – Lb.
			15	Nm
Max. Mounting Torque, M10 Terminal Screw			106	in. – Lb.
			12	Nm
Module Weight, Typical			5.33	kg
			11.75	lb
V Isolation @ 25C		V_{rms}	3000	V

Information presented is based upon manufacturers testing and projected capabilities.
 This information is subject to change without notice.
 The manufacturer makes no claim as to suitability of use, reliability, capability,
 of future availability of this product.

Electrical Characteristics, T_J=25°C unless otherwise specified

Characteristics	Symbol	Test Conditions	Min.	Max.	Units
Repetitive Peak Forward Leakage Current	I _{DRM}	Up to 1800V, T _J =125°C		100	mA
Repetitive Peak Reverse Leakage Current	I _{RRM}	Up to 1800V, T _J =125°C		100	mA
Peak On-State Voltage	V _{FM}	I _{TM} =3000A, T _J =125°C		1.30	V
Threshold Voltage, Low-level	V _{(TO)1}	T _J = 125°C, I = 15%I _{T(AV)} to πI _{T(AV)}		0.703	V
Slope Resistance, Low-level	r _{T1}			0.184	mΩ
Threshold Voltage, High-level	V _{(TO)2}	T _J = 125°C, I = πI _{T(AV)} to I _{TSM}		1.01	V
Slope Resistance, High-level	r _{T2}			0.117	mΩ
V _{TM} Coefficients, Full Range		T _J = 125°C, I = 50A to 6kA V _{TM} = A + B Ln I + C I + D Sqrt I	A = B = C = D =	0.7999 -4.62 E-02 7.33 E-05 1.10 E-02	
Minimum dV/dt	dV/dt	Exponential to 0.67V _{DRM} T _J =125°C, Gate Open	300		V/μs
Gate Trigger Current	I _{GT}	T _J =25°C, V _D =12V		200	mA
Gate Trigger Voltage	V _{GT}	T _J =25°C, V _D =12V		4.5	Volts
Non-Triggering Gate Voltage	V _{GDM}	T _J =125°C, V _D = ½ V _{DRM}		0.15	Volts
Holding Current	I _H			300	mA
Peak Forward Gate Current	I _{GTM}			4.0	Amp
Peak Reverse Gate Voltage	V _{GRM}			5	Volts
Maximum Average Gate Power Dissipation	P _{GM (AVE)}			16	Watts

Thermal Characteristics

Characteristics	Symbol		Max.	Units
Thermal Resistance, Junction to Case	R _{ΘJ-C}	Per Module, both conducting Per Junction, both conducting	0.029 0.058	°C/W °C/W
Thermal Impedance Coefficients	Z _{ΘJ-C}	Z _{ΘJ-C} = K ₁ (1-exp(-t/t ₁)) + K ₂ (1-exp(-t/t ₂)) + K ₃ (1-exp(-t/t ₃)) + K ₄ (1-exp(-t/t ₄))	K ₁ = 5.04 E-04 K ₂ = 2.31 E-03 K ₃ = 2.83 E-03 K ₄ = 5.24 E-02	t ₁ = 2.47 E-03 t ₂ = 4.42 E-02 t ₃ = 1.370 t ₄ = 9.668
Thermal Resistance, Case to Sink Lubricated	R _{ΘC-S}	Per Module	0.009	°C/W

Typical On-State Forward Voltage Drop
(T_J = 125°C)

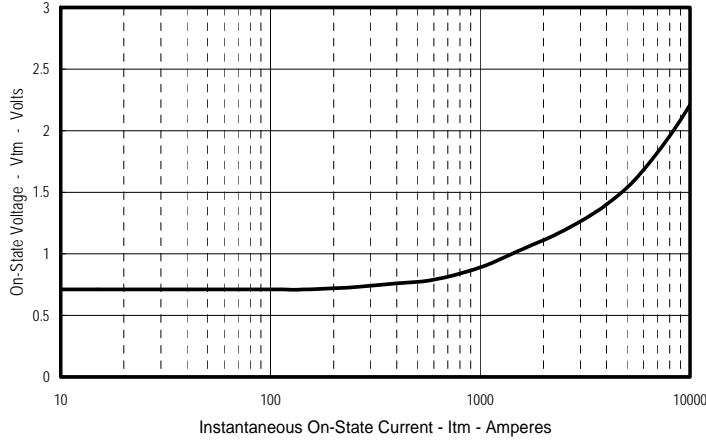

Maximum Transient Thermal Impedance
(Junction To Case)

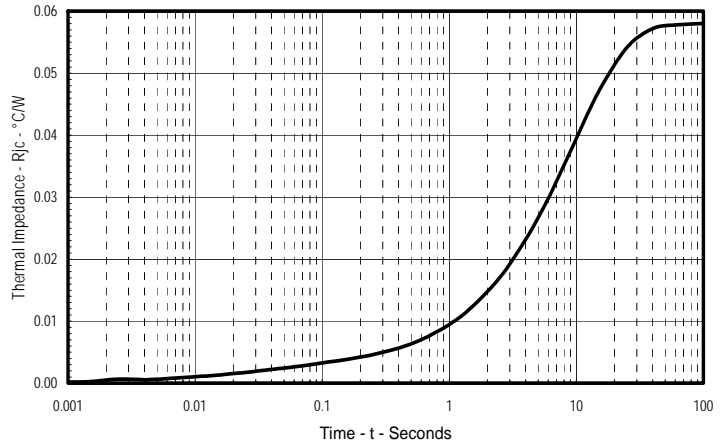

Maximum On-State Power Dissipation
(Sinusoidal Waveform)

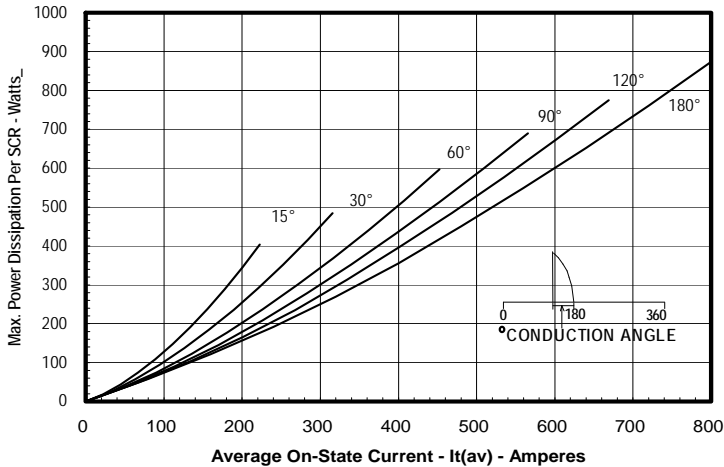

Maximum Allowable Case Temperature
(Sinusoidal Waveform)

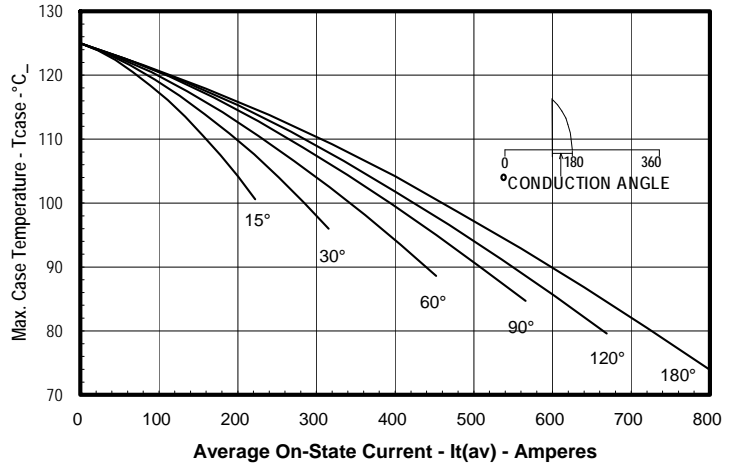

Maximum On-State Power Dissipation
(Rectangular Waveform)

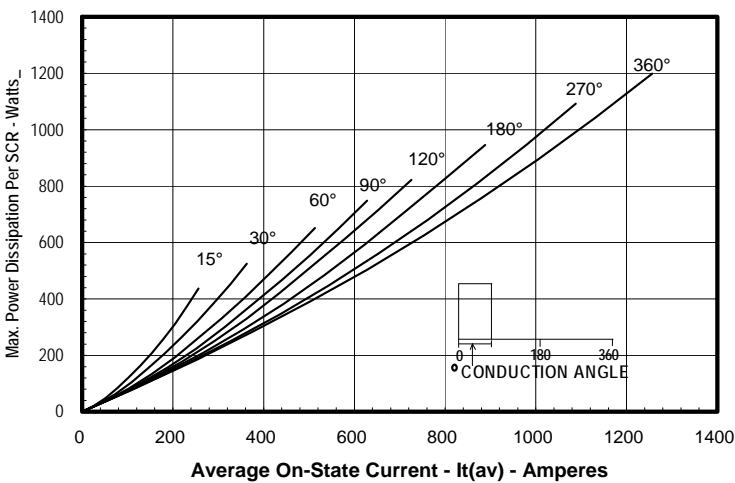

Maximum Allowable Case Temperature
(Rectangular Waveform)

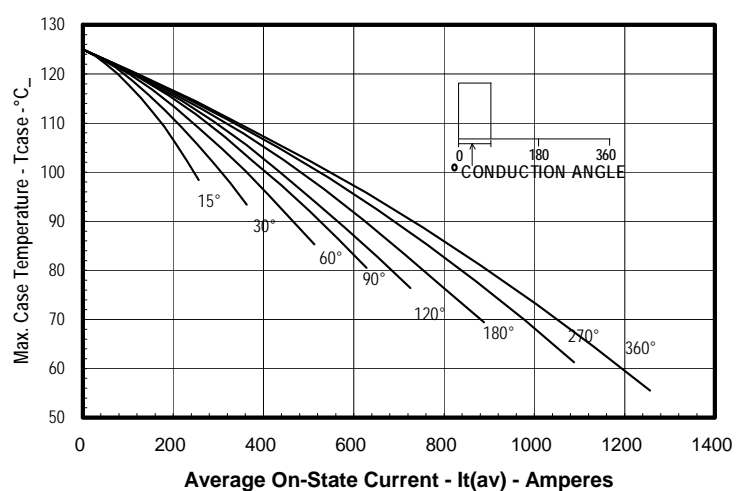

Powerex, Inc., 173 Pavilion Lane, Youngwood, Pennsylvania 15697 (724) 925-7272
www.pwrx.com

POW-R-BLOK™ AC Switch SCR Isolated Module 1550 Amps RMS, Up to 1800 Volts

DIM.	INCHES	MILLIMETERS
A	7.80	198.1
B	4.00	101.6
C	2.68	68.1
D	6.44	163.6
E	3.44	87.4
F	.28	7.1
G	7.31	185.7
H	7.00	177.8
J	1.65	42
K	.21	5.3
L	.28	7.1
M	.281	7.1
N	.45	11.4
P	.54	13.7
Q	5.93	150.6
R	.19	4.8
S	.11	2.8
T	.48	12.2
U	2.28	58
V	2.54	64.5
W	4.93	125.2
X	3.81	96.8
Y	.03	.8
Z	2.00	50.8
AA	1.00	25.4
BB	.50	12.7
CC	1.00	25.4
DD	.406	10.3
FF	.66	16.8

