

Powerex, Inc., 173 Pavilion Lane, Youngwood, Pennsylvania 15697 (724) 925-7272
www.pwr.com

POW-R-BLOK™ Dual SCR Isolated Module 250 Amperes / Up to 1600 Volts

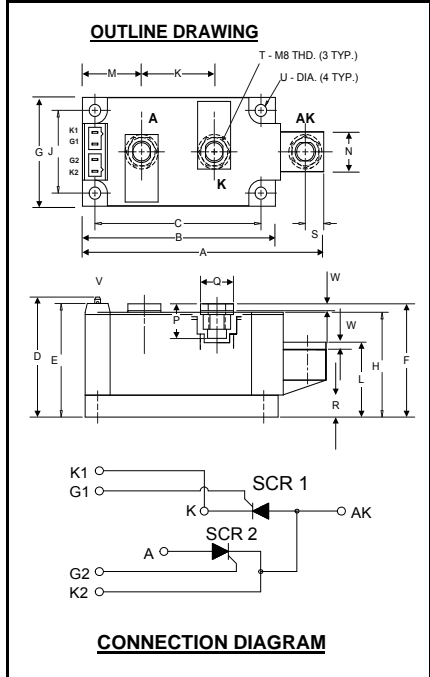

ND43__25
Dual SCR Isolated
POW-R-BLOK™ Module
250 Amperes / Up to 1600 Volts

Description:

Powerex Dual SCR Modules are designed for use in applications requiring phase control and isolated packaging. The modules are isolated for easy mounting with other components on a common heatsink. POW-R-BLOK™ has been tested and recognized by the Underwriters Laboratories.

Features:

- Electrically Isolated Heatsinking
- Aluminum Nitride Insulator
- Compression Bonded Elements
- Metal Baseplate
- Low Thermal Impedance for Improved Current Capability
- Quick Connect Gate Terminal with Provision for Keyed Mating Plug
- UL Recognized

ND43 Outline Dimensions

Dimension	Inches	Millimeters
A	4.57	116
B	3.66	93
C	3.15	80.0
D	2.17	55.1
E	2.06	52.3
F	2.07	52.0
G	1.97	50.0
H	1.90	48.3
J	1.50	38.1
K	1.38	35.0
L	1.26	32.0
M	1.122	28.5
N	.71	18.0
P	.57	14.5
Q	.625	15.9
R	.394	10.00
S	.350	8.9
T	M8 Metric	M8
U	.250 Dia.	6.35 Dia.
V	.110 x .032	2.8 x 0.8
W	.12	3.0

Note: Dimensions are for reference only.

Ordering Information:

Select the complete eight digit module part number from the table below.

Example: ND431625 is a 1600Volt, 250 Ampere Dual SCR Isolated POW-R-BLOK™ Module

Type	Voltage Volts (x100)	Current Amperes (x 10)
ND43	06	25
	08	
	10	
	12	
	14	
16		

Benefits:

- No Additional Insulation Components Required
- Easy Installation
- No Clamping Components Required
- Reduce Engineering Time

Applications:

- Bridge Circuits
- AC & DC Motor Drives
- Battery Supplies
- Power Supplies
- Large IGBT Circuit Front Ends

Absolute Maximum Ratings

Characteristics	Conditions	Symbol		Units
Repetitive Peak Forward and Reverse Blocking Voltage		V_{DRM} & V_{RRM}	up to 1600	V
Non-Repetitive Peak Reverse Blocking Voltage ($t < 5$ msec)		V_{RSM}	1600	V
RMS Forward Current	180° Conduction, $T_C=89^\circ\text{C}$	$I_{T(RMS)}$	393	A
Average Forward Current	180° Conduction, $T_C=89^\circ\text{C}$	$I_{T(AV)}$	250	A
Peak One Cycle Surge Current, Non-Repetitive	60 Hz, 100% V_{RRM} reapplied	I_{TSM}	8800	A
Peak Three Cycle Surge Current, Non-Repetitive	60 Hz, 100% V_{RRM} reapplied	I_{TSM}	4685	A
Peak Ten Cycle Surge Current, Non-Repetitive	60 Hz, 100% V_{RRM} reapplied	I_{TSM}	4040	A
I^2t for Fusing for One Cycle, 8.3 milliseconds		I^2t	322,000	A^2sec
Maximum Rate-of-Rise of On-State Current, (Non-Repetitive)	$T_j=25^\circ\text{C}$, $I_G=500\text{mA}$, $V_D=0.67 V_{DRM}(\text{Rated})$, $I_{TM}=\pi I_{T(AV)}$, $T_r < 0.5\mu\text{s}$, $t_p > 6\mu\text{s}$	di/dt	800	$\text{A}/\mu\text{s}$
Peak Gate Power Dissipation		P_{GM}	16	W
Average Gate Power Dissipation		$P_{G(AV)}$	3	W
Peak Forward Gate Current		I_{GFM}	4	A
Peak Forward Gate Voltage		V_{GFM}	10	V
Peak Reverse Gate Voltage		V_{GRM}	5	V
Operating Temperature		T_J	-40 to +130	$^\circ\text{C}$
Storage Temperature		T_{stg}	-40 to +150	$^\circ\text{C}$
Max. Mounting Torque, M6 Mounting Screw			45 5	in.-Lb. Nm
Max. Mounting Torque, M8 Terminal Screw			110 12	in.-Lb. Nm
Module Weight, Typical			840 1.85	g lb
V Isolation @ 25C		V_{rms}	2500	V

Electrical Characteristics, T_J=25°C unless otherwise specified

Characteristics	Symbol	Test Conditions	Min.	Max.	Units
Repetitive Peak Forward Leakage Current	I _{DRM}	Up to 1600V, T _J =130°C		50	mA
Repetitive Peak Reverse Leakage Current	I _{RDM}	Up to 1600V, T _J =130°C		50	mA
Peak On-State Voltage	V _{FM}	I _{TM} =625A		1.30	V
Threshold Voltage, Low-level	V _{(TO)1}	T _J = 130°C, I = 15%I _{T(AV)} to 1I _{T(AV)}		0.819	V
Slope Resistance, Low-level	r _{T1}			0.589	mΩ
Threshold Voltage, High-level	V _{(TO)2}	T _J = 130°C, I = 1I _{T(AV)} to I _{TSM}		0.47	V
Slope Resistance, High-level	r _{T2}			0.731	mΩ
V _{TM} Coefficients, Full Range		T _J = 130°C, I = 15%I _{T(AV)} to I _{TSM}	A =	0.5849	
			B =	0.1060	
		V _{TM} = A + B Ln I + C I + D Sqrt I	C =	9.25 E-4	
			D =	-0.0286	
Minimum dV/dt	dV/dt	Exponential to 2/3 V _{DRM} T _J =130°C, Gate Open	500		V/μs
Turn-On Time (Typical)	t _{on}	I _{TM} = 100A, V _D = 100V	7	(Typical)	μs
Turn-Off Time (Typical)	t _{off}	T _J = 130°C, I _T = 250A Re-Applied dV/dt = 20V/μs Linear to 0.8 V _{DRM}	150	(Typical)	μs
Gate Trigger Current	I _{GT}	T _J =25°C, V _D =12V		150	mA
Gate Trigger Voltage	V _{GT}	T _J =25°C, V _D =12V		3.0	Volts
Non-Triggering Gate Voltage	V _{GDM}	T _J =130°C, V _D = 1/2 V _{DRM}		0.15	Volts

Thermal Characteristics

Characteristics	Symbol		Max.	Units
Thermal Resistance, Junction to Case	R _{ΘJ-C}	Per Module, both conducting Per Junction both conducting	0.07 0.14	°C/W °C/W
Thermal Impedance Coefficients	Z _{ΘJ-C}	Z _{ΘJ-C} = K ₁ (1-exp(-t/τ ₁)) + K ₂ (1-exp(-t/τ ₂)) + K ₃ (1-exp(-t/τ ₃)) + K ₄ (1-exp(-t/τ ₄))	K ₁ = 5.27E-3 K ₂ = 1.17E-2 K ₃ = 5.26E-2 K ₄ = 6.97E-2	τ ₁ = 1.69E-4 τ ₂ = 2.07E-2 τ ₃ = 2.37E-1 τ ₄ = 2.46
Thermal Resistance, Case to Sink Lubricated	R _{ΘC-S}	Per Module	0.03	°C/W

Maximum On-State Forward Voltage Drop

(T_j = 130 °C)

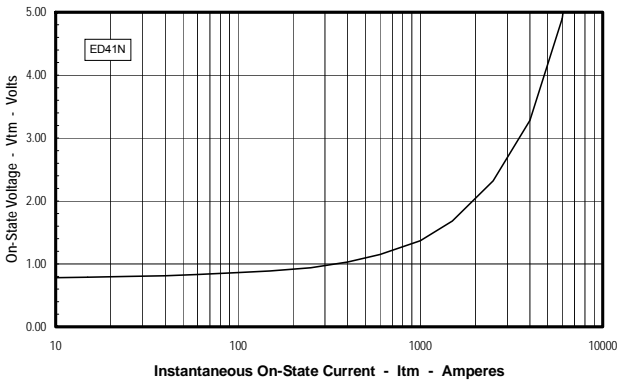

Maximum Transient Thermal Impedance

(Junction to Case, Per SCR)

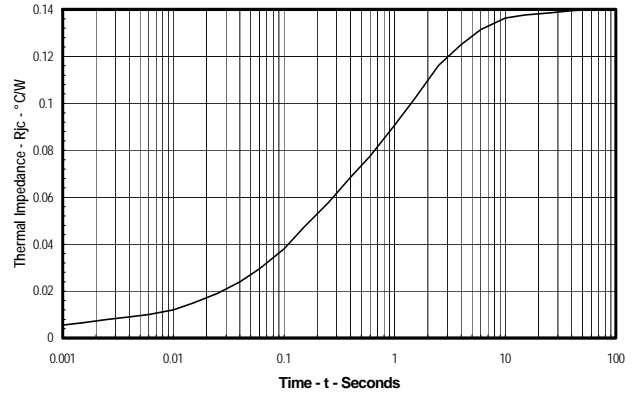

Maximum On-State Power Dissipation

(Sinusoidal Waveform)

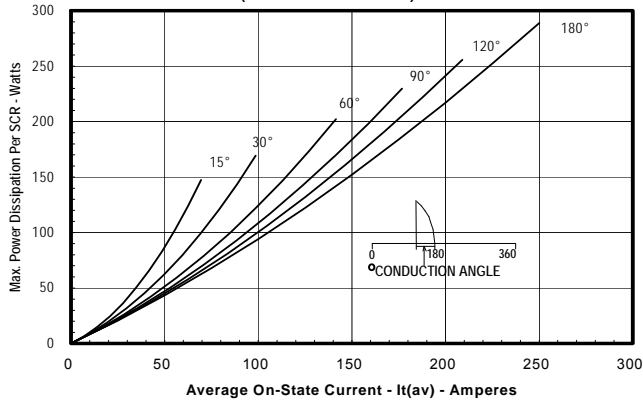

Maximum Allowable Case Temperature

(Sinusoidal Waveform)

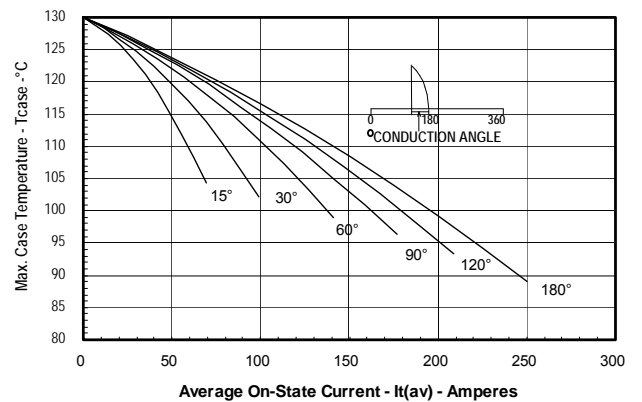

Maximum On-State Power Dissipation

(Rectangular Waveform)

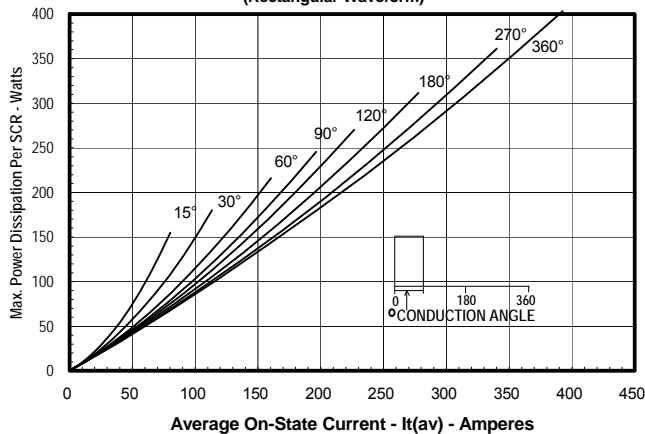

Maximum Allowable Case Temperature

(Rectangular Waveform)

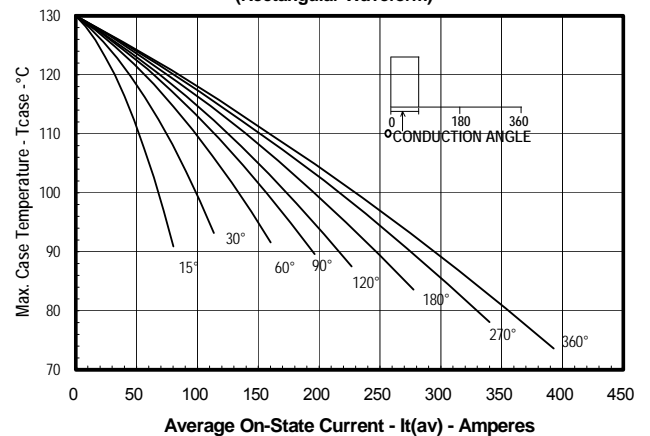

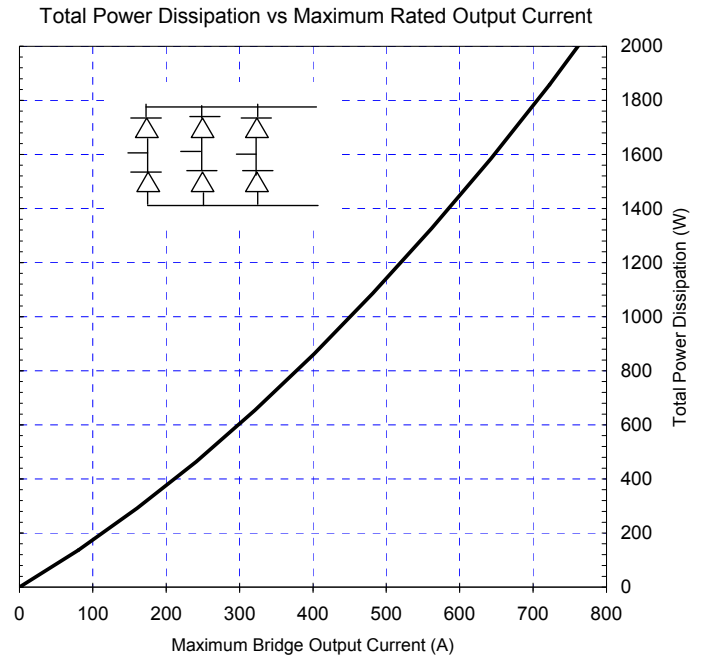
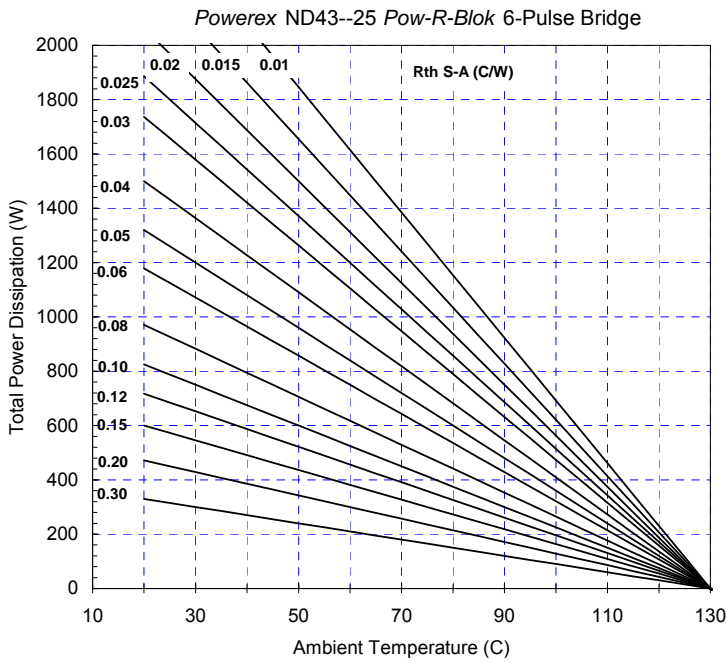

Six-Pulse Bridge Circuit Total Power Dissipation & Maximum Rated Output Current With Sink to Ambient Resistance of Heatsink as a Parameter.