

Powerex, Inc., 173 Pavilion Ln, Youngwood, Pennsylvania 15697 (724) 925-7272
www.pwr.com

POW-R-BLOK™ Dual SCR Isolated Module 330 Amperes / Up to 1600 Volts

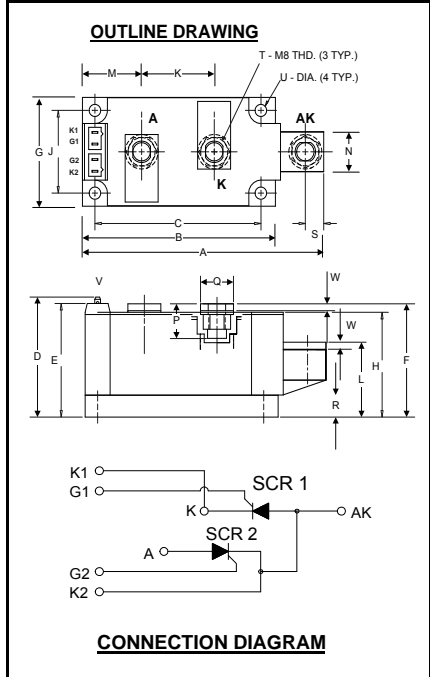

ND43__33
Dual SCR Isolated
POW-R-BLOK™ Module
330 Amperes / Up to 1600 Volts

Description:

Powerex Dual SCR Modules are designed for use in applications requiring phase control and isolated packaging. The modules are isolated for easy mounting with other components on a common heatsink. POW-R-BLOK™ has been tested and recognized by the Underwriters Laboratories.

Features:

- Electrically Isolated Heatsinking
- Aluminum Nitride Insulator
- Compression Bonded Elements
- Metal Baseplate
- Low Thermal Impedance for Improved Current Capability
- Quick Connect Gate Terminal with Provision for Keyed Mating Plug
- UL Recognized

Benefits:

- No Additional Insulation Components Required
- Easy Installation
- No Clamping Components Required
- Reduce Engineering Time

Applications:

- Bridge Circuits
- AC & DC Motor Drives
- Battery Supplies
- Power Supplies
- Large IGBT Circuit Front Ends

ND43 Outline Dimensions

Dimension	Inches	Millimeters
A	4.57	116
B	3.66	93
C	3.15	80.0
D	2.17	55.1
E	2.06	52.3
F	2.07	52.0
G	1.97	50.0
H	1.90	48.3
J	1.50	38.1
K	1.38	35.0
L	1.35	34.3
M	1.122	28.5
N	.71	18.0
P	.57	14.5
Q	.625	15.9
R	.394	10.00
S	.350	8.9
T	M8 Metric	M8
U	.250 Dia.	6.35 Dia.
V	.110 x .032	2.8 x 0.8
W	.12	3.0

Note: Dimensions are for reference only.

Ordering Information:

Select the complete eight digit module part number from the table below.

Example: ND431633 is a 1600Volt, 330 Ampere Dual SCR Isolated POW-R-BLOK™ Module

Type	Voltage Volts (x100)	Current Amperes (x 10)
ND43	06 08 10 12 14 16	33

Absolute Maximum Ratings

Characteristics	Conditions	Symbol	Units
Repetitive Peak Forward and Reverse Blocking Voltage		V_{DRM} & V_{RRM}	up to 1600 V
Non-Repetitive Peak Reverse Blocking Voltage	($t < 5$ msec)	V_{RSM}	1600 V
RMS Forward Current	180° Conduction, $T_C=71^\circ\text{C}$	$I_{T(RMS)}$	520 A
	180° Conduction, $T_C=78^\circ\text{C}$	$I_{T(RMS)}$	480 A
Average Forward Current	180° Conduction, $T_C=71^\circ\text{C}$	$I_{T(AV)}$	330 A
	180° Conduction, $T_C=78^\circ\text{C}$	$I_{T(AV)}$	305 A
Peak One Cycle Surge Current, Non-Repetitive	60 Hz, $V_f=V_{RRM}$, $T_j=T_{jmax}$	I_{FSM}	8,800 A
	50 Hz, $V_f=V_{RRM}$, $T_j=T_{jmax}$	I_{FSM}	7,920 A
	60 Hz, $V_f=V_{RRM}$, $T_j=25^\circ\text{C}$	I_{FSM}	10,210 A
	50 Hz, $V_f=V_{RRM}$, $T_j=25^\circ\text{C}$	I_{FSM}	9,180 A
	60 Hz, $V_f=0$, $T_j=T_{jmax}$	I_{FSM}	13,200 A
	50 Hz, $V_f=0$, $T_j=T_{jmax}$	I_{FSM}	11,850 A
	60 Hz, $V_f=0$, $T_j=25^\circ\text{C}$	I_{FSM}	15,310 A
	50 Hz, $V_f=0$, $T_j=25^\circ\text{C}$	I_{FSM}	13,780 A
Peak Three Cycle Surge Current, Non-Repetitive	60 Hz, $V_f=0$, $T_j=T_{jmax}$	I_{FSM}	10,590 A
	50 Hz, $V_f=0$, $T_j=1T_{jmax}$	I_{FSM}	9,530 A
	60 Hz, $V_f=0$, $T_j=25^\circ\text{C}$	I_{FSM}	12,290 A
	50 Hz, $V_f=0$, $T_j=25^\circ\text{C}$	I_{FSM}	11,060 A
Peak Ten Cycle Surge Current, Non-Repetitive	60 Hz, $V_f=0$, $T_j=T_{jmax}$	I_{FSM}	8,325 A
	50 Hz, $V_f=0$, $T_j=T_{jmax}$	I_{FSM}	7,490 A
	60 Hz, $V_f=0$, $T_j=25^\circ\text{C}$	I_{FSM}	9,660 A
	50 Hz, $V_f=0$, $T_j=25^\circ\text{C}$	I_{FSM}	8,690 A
I^2t for Fusing for One Cycle, 8.3 milliseconds ($V_f=0$)	8.3 milliseconds, $T_j=T_{jmax}$	I^2t	726,000 A^2sec
	8.3 milliseconds, $T_j=T_{jmax}$	I^2t	977,000 A^2sec
	10 milliseconds, $T_j=150^\circ\text{C}$	I^2t	706,000 A^2sec
	10 milliseconds, $T_j=25^\circ\text{C}$	I^2t	950,000 A^2sec
Maximum Rate-of-Rise of On-State Current, (Non-Repetitive)	$T_j=25^\circ\text{C}$, $I_G=500\text{mA}$, $V_D=0.67 V_{DRM}(\text{Rated})$, $I_{TM}=\pi I_{T(AV)}$, $T_r < 0.5\mu\text{s}$, $t_p > 6\mu\text{s}$	di/dt	800 A/ μs
Peak Gate Power Dissipation		P_{GM}	16 W
Average Gate Power Dissipation		$P_{G(AV)}$	3 W
Peak Forward Gate Current		I_{GFM}	4 A
Peak Forward Gate Voltage		V_{GFM}	10 V
Peak Reverse Gate Voltage		V_{GRM}	5 V
Operating Temperature		T_j	-40 to +130 °C
Storage Temperature		T_{stg}	-40 to +150 °C
Max. Mounting Torque, M6 Mounting Screw			45 in.-Lb.
			5 Nm
Max. Mounting Torque, M8 Terminal Screw			110 in.-Lb.
			12 Nm
Module Weight, Typical			840 g
			1.85 lb
V Isolation @ 25C		V_{rms}	2500 V

Electrical Characteristics, T_J=25°C unless otherwise specified

Characteristics	Symbol	Test Conditions	Min.	Max.	Units
Repetitive Peak Forward Leakage Current	I _{DRM}	Up to 1600V, T _J =130°C		50	mA
Repetitive Peak Reverse Leakage Current	I _{RDM}	Up to 1600V, T _J =130°C		50	mA
Peak On-State Voltage	V _{FM}	I _{TM} =625A		1.30	V
Threshold Voltage, Low-level	V _{(TO)1}	T _J = 130°C, I = 15%I _{T(AV)} to π I _{T(AV)}		0.819	V
Slope Resistance, Low-level	r _{T1}			0.589	mΩ
Threshold Voltage, High-level	V _{(TO)2}	T _J = 130°C, I = π I _{T(AV)} to I _{TSM}		0.47	V
Slope Resistance, High-level	r _{T2}			0.731	mΩ
V _{TM} Coefficients, Full Range		T _J = 130°C, I = 15%I _{T(AV)} to I _{TSM} V _{TM} = A + B Ln I + C I + D Sqrt I	A = B = C = D =	0.5849 0.1060 9.25 E-4 -0.0286	
Minimum dV/dt	dV/dt	Exponential to 2/3 V _{DRM} T _J =130°C, Gate Open	500		V/μs
Turn-On Time (Typical)	t _{on}	I _{TM} = 100A, V _D = 100V	7	(Typical)	μs
Turn-Off Time (Typical)	t _{off}	T _J = 130°C, I _T = 250A Re-Applied dV/dt = 20V/μs Linear to 0.8 V _{DRM}	150	(Typical)	μs
Gate Trigger Current	I _{GT}	T _J =25°C, V _D =12V		150	mA
Gate Trigger Voltage	V _{GT}	T _J =25°C, V _D =12V		3.0	Volts
Non-Triggering Gate Voltage	V _{GDM}	T _J =130°C, V _D = 1/2 V _{DRM}		0.15	Volts

Thermal Characteristics

Characteristics	Symbol		Max.	Units
Thermal Resistance, Junction to Case	R _{ΘJ-C}	Per Module, both conducting Per Junction both conducting	0.07 0.14	°C/W °C/W
Thermal Impedance Coefficients	Z _{ΘJ-C}	Z _{ΘJ-C} = K ₁ (1-exp(-t/τ ₁)) + K ₂ (1-exp(-t/τ ₂)) + K ₃ (1-exp(-t/τ ₃)) + K ₄ (1-exp(-t/τ ₄))	K ₁ = 5.27E-3 K ₂ = 1.17E-2 K ₃ = 5.26E-2 K ₄ = 6.97E-2	τ ₁ = 1.69E-4 τ ₂ = 2.07E-2 τ ₃ = 2.37E-1 τ ₄ = 2.46
Thermal Resistance, Case to Sink Lubricated	R _{ΘC-S}	Per Module	0.03	°C/W

Information presented is based upon manufacturers testing and projected capabilities.
 This information is subject to change without notice.
 The manufacturer makes no claim as to suitability for us, reliability, capability,
 or future availability of this product.

Maximum On-State Forward Voltage Drop
($T_J = 130^\circ\text{C}$)

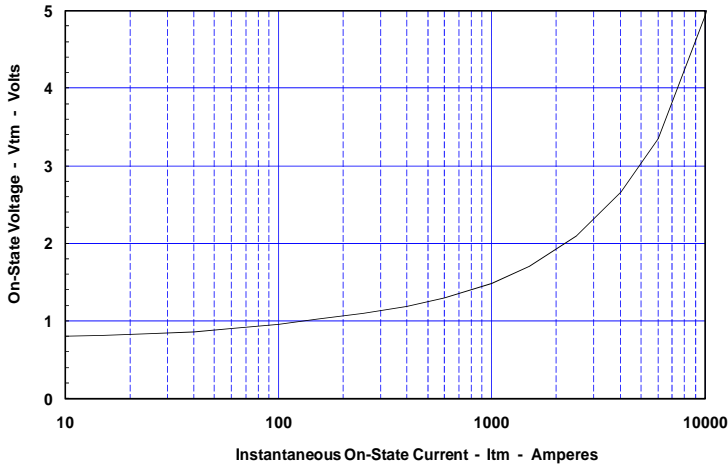

Maximum Transient Thermal Impedance
(Junction to Case)

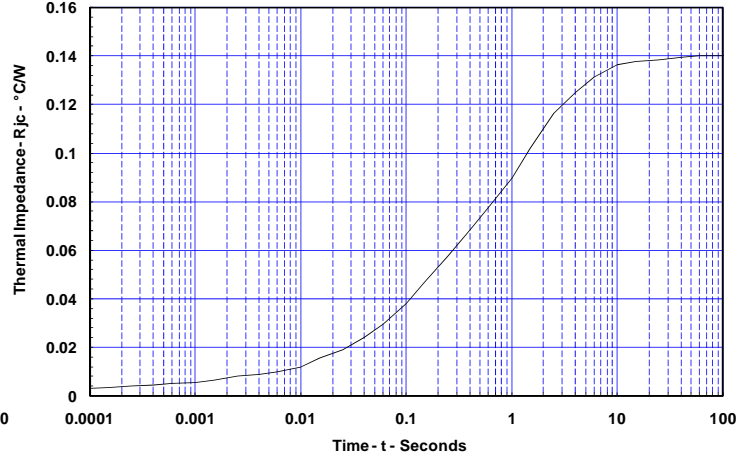

Maximum On-State Power Dissipation
(Sinusoidal Waveform)

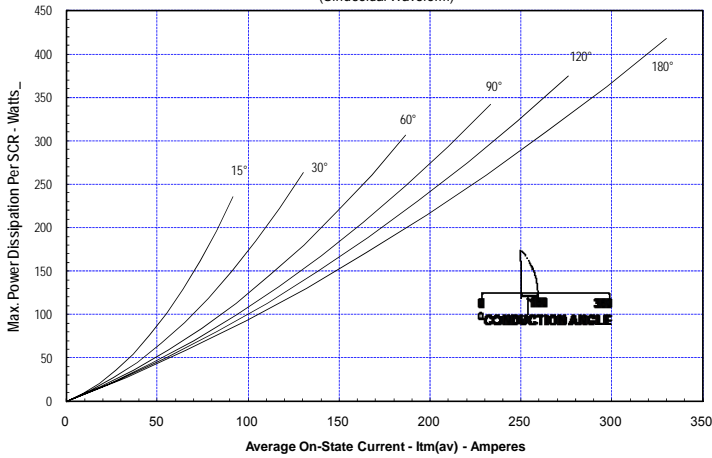

Maximum Allowable Case Temperature
(Sinusoidal Waveform)

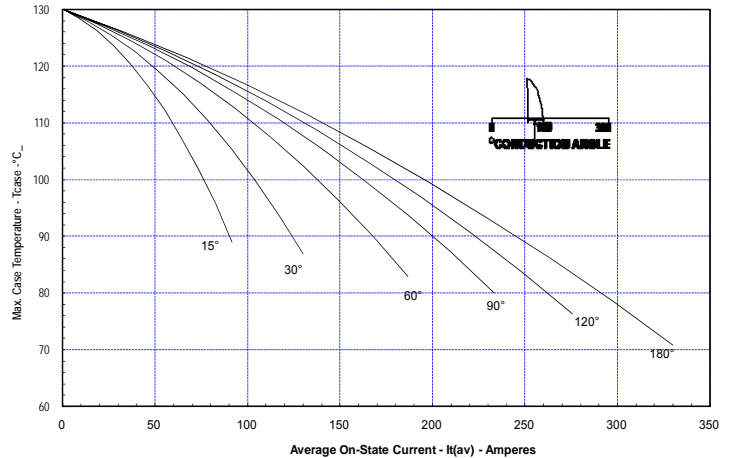

Maximum On-State Power Dissipation
(Rectangular Waveform)

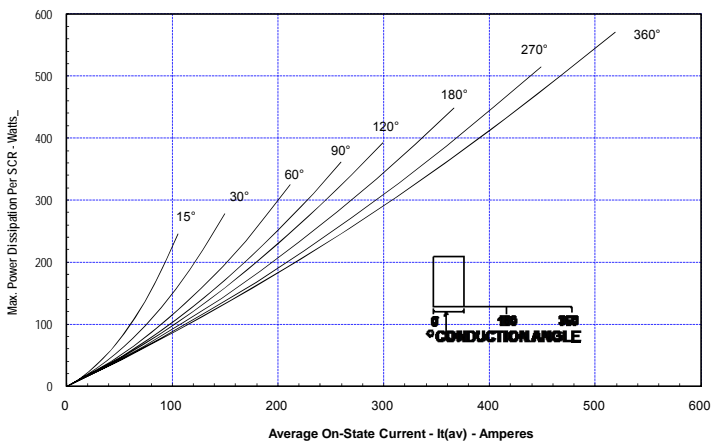

Maximum Allowable Case Temperature
(Rectangular Waveform)

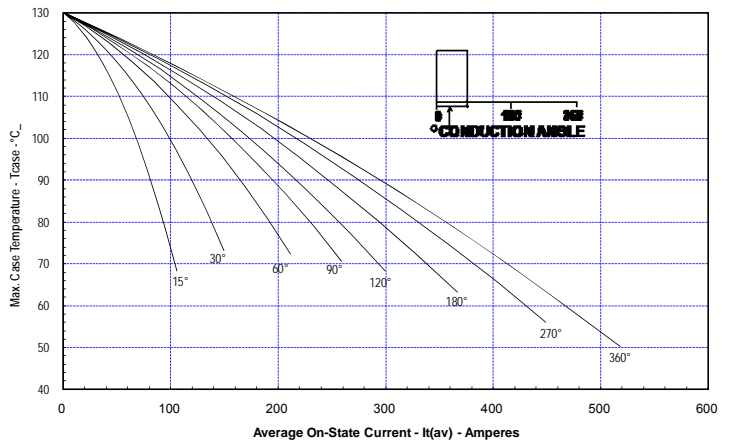

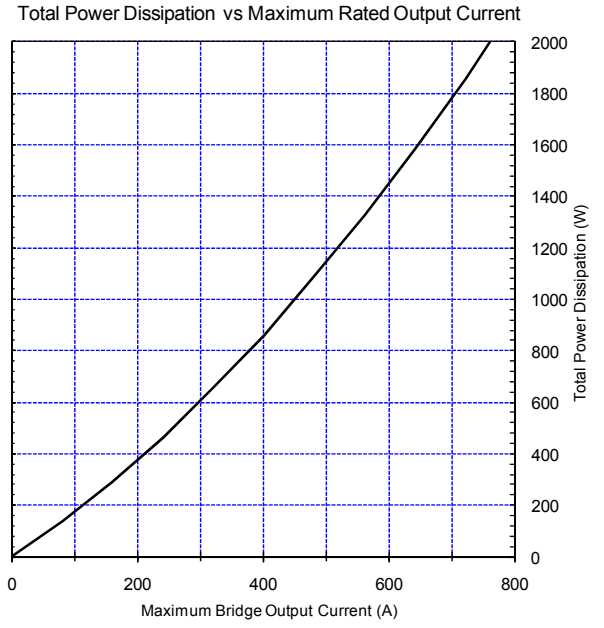
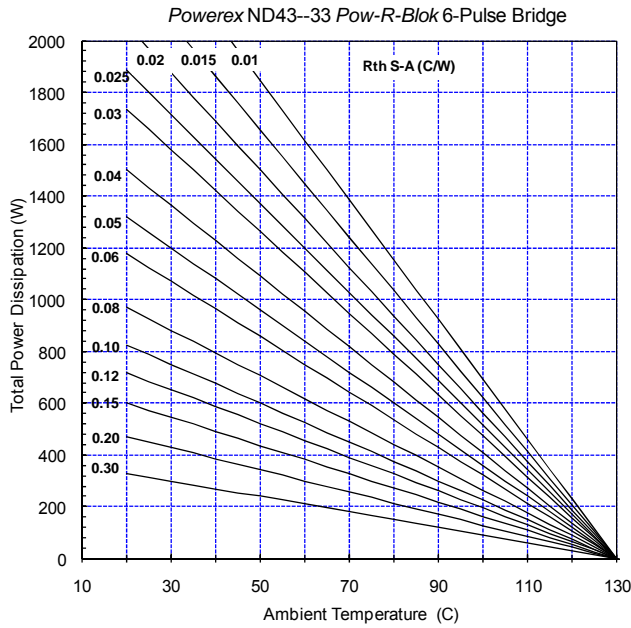

Six-Pulse Bridge Circuit Total Power Dissipation & Maximum Rated Output Current With Sink to Ambient Resistance of Heatsink as a Parameter.