

Powerex, Inc., 173 Pavilion Lane, Youngwood, Pennsylvania 15697 (724) 925-7272  
www.pwr.com

### POW-R-BLOK™ Dual SCR/Diode Isolated Module 250 Amperes / Up to 1600 Volts

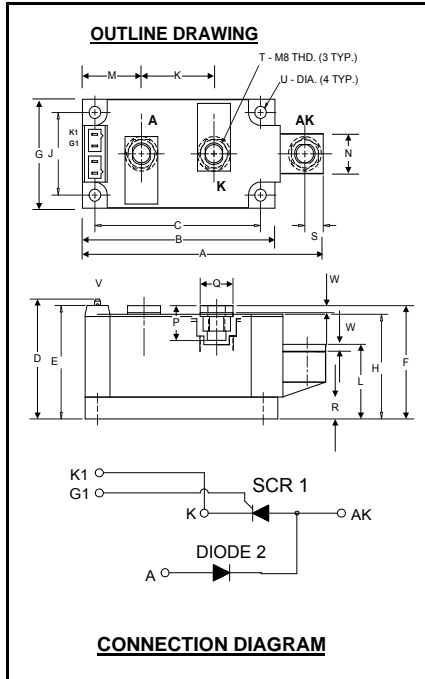

**ND42\_25**  
**Dual SCR/Diode Isolated**  
**POW-R-BLOK™ Module**  
250 Amperes / 600-1600 Volts

#### Description:

Powerex Dual SCR/Diode Modules are designed for use in applications requiring phase control and isolated packaging. The modules are isolated for easy mounting with other components on a common heatsink. *POW-R-BLOK™* has been tested and recognized by the Underwriters Laboratories.

#### Features:

- Electrically Isolated Heatsinking
- Aluminum Nitride Insulator
- Compression Bonded Elements
- Metal Baseplate
- Low Thermal Impedance for Improved Current Capability
- Quick Connect Gate Terminal with Provision for Keyed Mating Plug
- UL Recognized

#### ND42 Outline Dimensions

Dimension	Inches	Millimeters
A	4.57	116
B	3.66	93
C	3.15	80.0
D	2.17	55.1
E	2.06	52.3
F	2.07	52.0
G	1.97	50.0
H	1.90	48.3
J	1.50	38.1
K	1.38	35.0
L	1.26	32.0
M	1.122	28.5
N	.71	18.0
P	.57	14.5
Q	.625	15.9
R	.394	10.00
S	.350	8.9
T	M8 Metric	M8
U	.250 Dia.	6.35 Dia.
V	.110 x .032	2.8 x 0.8
W	.12	3.0

Note: Dimensions are for reference only.

#### Ordering Information:

Select the complete eight digit module part number from the table below.

Example: ND421625 is a 1600Volt, 250 Ampere Dual SCR/Diode Isolated *POW-R-BLOK™* Module

Type	Voltage Volts (x100)	Current Amperes (x 10)
ND42	06	25
	08	
	10	
	12	
	14	
16		

#### Benefits:

- No Additional Insulation Components Required
- Easy Installation
- No Clamping Components Required
- Reduce Engineering Time

#### Applications:

- Bridge Circuits
- AC & DC Motor Drives
- Battery Supplies
- Power Supplies
- Large IGBT Circuit Front Ends

**Absolute Maximum Ratings**

Characteristics	Conditions	Symbol		Units
Repetitive Peak Forward and Reverse Blocking Voltage		$V_{DRM}$ & $V_{RRM}$	up to 1600	V
Non-Repetitive Peak Reverse Blocking Voltage ( $t < 5$ msec)		$V_{RSM}$	1600	V
RMS Forward Current	180° Conduction, $T_C=89^\circ\text{C}$	$I_{T(RMS)}$	393	A
Average Forward Current	180° Conduction, $T_C=89^\circ\text{C}$	$I_{T(AV)}/I_{F(AV)}$	250	A
Peak One Cycle Surge Current, Non-Repetitive	60 Hz, 100% $V_{RRM}$ reapplied	$I_{TSM}/I_{FSM}$	8800	A
Peak Three Cycle Surge Current, Non-Repetitive	60 Hz, 100% $V_{RRM}$ reapplied	$I_{TSM}/I_{FSM}$	4685	A
Peak Ten Cycle Surge Current, Non-Repetitive	60 Hz, 100% $V_{RRM}$ reapplied	$I_{TSM}/I_{FSM}$	4040	A
$I^2t$ for Fusing for One Cycle, 8.3 milliseconds		$I^2t$	322,000	$\text{A}^2 \text{sec}$
Maximum Rate-of-Rise of On-State Current, (Non-Repetitive)	$T_J=25^\circ\text{C}$ , $I_G=500\text{mA}$ , $V_D=0.67 V_{DRM}(\text{Rated})$ , $I_{TM}=\pi I_{T(AV)}$ , $T_r < 0.5\mu\text{s}$ , $t_p > 6\mu\text{s}$	$di/dt$	800	$\text{A}/\mu\text{s}$
Peak Gate Power Dissipation		$P_{GM}$	16	W
Average Gate Power Dissipation		$P_{G(AV)}$	3	W
Peak Forward Gate Current		$I_{GFM}$	4	A
Peak Forward Gate Voltage		$V_{GFM}$	10	V
Peak Reverse Gate Voltage		$V_{GRM}$	5	V
Operating Temperature		$T_J$	-40 to +130	$^\circ\text{C}$
Storage Temperature		$T_{stg}$	-40 to +150	$^\circ\text{C}$
Max. Mounting Torque, M6 Mounting Screw			45 5	in.-Lb. Nm
Max. Mounting Torque, M8 Terminal Screw			110 12	in.-Lb. Nm
Module Weight, Typical			840 1.85	g lb
V Isolation @ 25C		$V_{rms}$	2500	V

**Electrical Characteristics, T<sub>J</sub>=25°C unless otherwise specified**

Characteristics	Symbol	Test Conditions	Min.	Max.	Units
Repetitive Peak Forward Leakage Current	I <sub>DRM</sub>	Up to 1600V, T <sub>J</sub> =130°C		50	mA
Repetitive Peak Reverse Leakage Current	I <sub>RDM</sub>	Up to 1600V, T <sub>J</sub> =130°C		50	mA
Peak On-State Voltage	V <sub>TM</sub> / V <sub>FM</sub>	I <sub>TM</sub> / I <sub>FM</sub> = 625A		1.30	V
Threshold Voltage, Low-level	V <sub>(TO)1</sub>	T <sub>J</sub> = 130°C, I = 15% I <sub>T(AV)</sub> to 1 I <sub>T(AV)</sub>		0.819	V
Slope Resistance, Low-level	r <sub>T1</sub>			0.589	mΩ
Threshold Voltage, High-level	V <sub>(TO)2</sub>	T <sub>J</sub> = 130°C, I = 1 I <sub>T(AV)</sub> to I <sub>TSM</sub>		0.47	V
Slope Resistance, High-level	r <sub>T2</sub>			0.731	mΩ
V <sub>TM</sub> / V <sub>FM</sub> Coefficients, Full Range		T <sub>J</sub> = 130°C, I = 15% I <sub>T(AV)</sub> to I <sub>TSM</sub>	A =	0.5849	
			B =	0.1060	
		V <sub>TM</sub> / V <sub>FM</sub> = A + B Ln I + C I + D Sqrt I	C =	9.25 E-4	
			D =	-0.0286	
Minimum dV/dt	dV/dt	Exponential to 2/3 V <sub>DRM</sub> T <sub>J</sub> =130°C, Gate Open	500		V/μs
Turn-On Time (Typical)	t <sub>on</sub>	I <sub>TM</sub> = 100A, V <sub>D</sub> = 100V	7	(Typical)	μs
Turn-Off Time (Typical)	t <sub>off</sub>	T <sub>J</sub> = 130°C, I <sub>T</sub> = 250A Re-Applied dV/dt = 20V/μs Linear to 0.8 V <sub>DRM</sub>	150	(Typical)	μs
Gate Trigger Current	I <sub>GT</sub>	T <sub>J</sub> =25°C, V <sub>D</sub> =12V		150	mA
Gate Trigger Voltage	V <sub>GT</sub>	T <sub>J</sub> =25°C, V <sub>D</sub> =12V		3.0	Volts
Non-Triggering Gate Voltage	V <sub>GDM</sub>	T <sub>J</sub> =130°C, V <sub>D</sub> = 1/2 V <sub>DRM</sub>		0.15	Volts

**Thermal Characteristics**

Characteristics	Symbol		Max.	Units
Thermal Resistance, Junction to Case	R <sub>ΘJ-C</sub>	Per Module, both conducting Per Junction both conducting	0.07 0.14	°C/W °C/W
Thermal Impedance Coefficients	Z <sub>ΘJ-C</sub>	Z <sub>ΘJ-C</sub> = K <sub>1</sub> (1-exp(-t/τ <sub>1</sub> )) + K <sub>2</sub> (1-exp(-t/τ <sub>2</sub> )) + K <sub>3</sub> (1-exp(-t/τ <sub>3</sub> )) + K <sub>4</sub> (1-exp(-t/τ <sub>4</sub> ))	K <sub>1</sub> = 5.27E-3 K <sub>2</sub> = 1.17E-2 K <sub>3</sub> = 5.26E-2 K <sub>4</sub> = 6.97E-2	τ <sub>1</sub> = 1.69E-4 τ <sub>2</sub> = 2.07E-2 τ <sub>3</sub> = 2.37E-1 τ <sub>4</sub> = 2.46
Thermal Resistance, Case to Sink Lubricated	R <sub>ΘC-S</sub>	Per Module	0.03	°C/W

Powerex, Inc., 173 Pavilion Lane, Youngwood, Pennsylvania 15697 (724) 925-7272  
www.pwr.com

## POW-R-BLOK™ Dual SCR/Diode Isolated Module 250 Amperes / Up to 1600 Volts

**Maximum On-State Forward Voltage Drop**  
( $T_j = 130^\circ\text{C}$ )

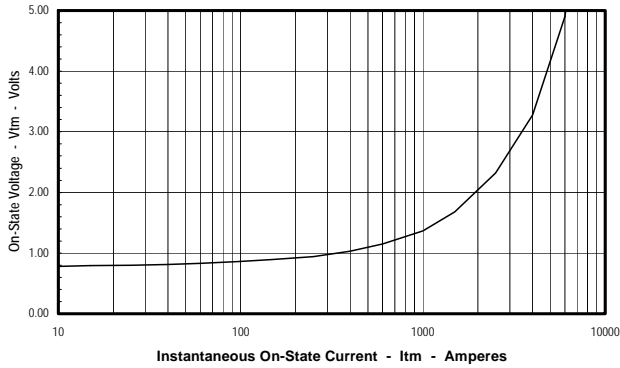

**Maximum Transient Thermal Impedance**  
(Junction to Case, Per Junction)

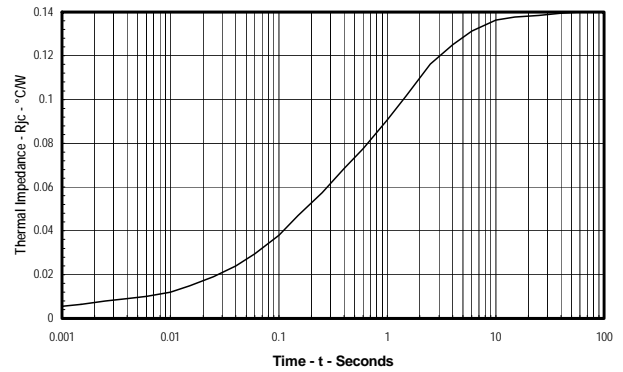

**Maximum On-State Power Dissipation**  
(Sinusoidal Waveform)

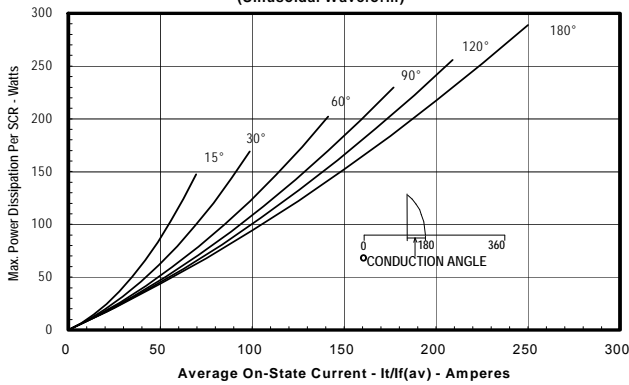

**Maximum Allowable Case Temperature**  
(Sinusoidal Waveform)

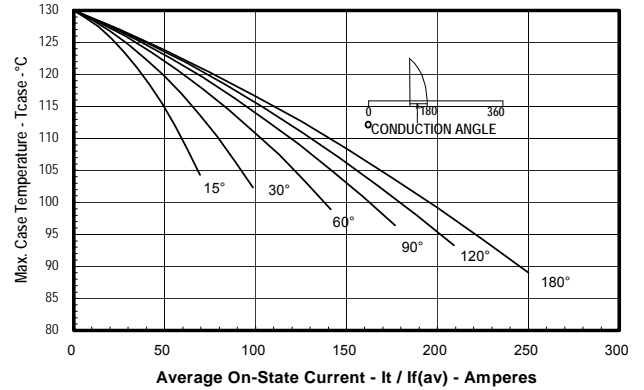

**Maximum On-State Power Dissipation**  
(Rectangular Waveform)

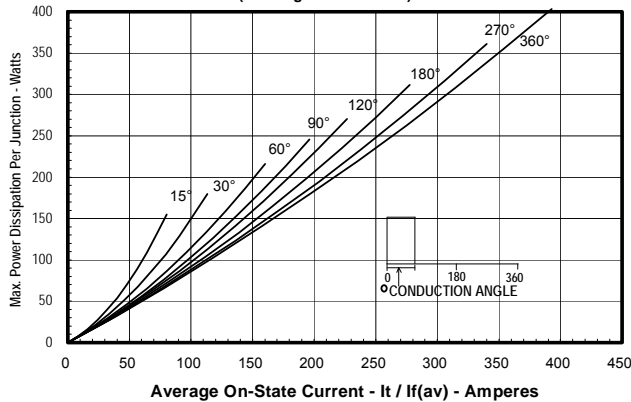

**Maximum Allowable Case Temperature**  
(Rectangular Waveform)

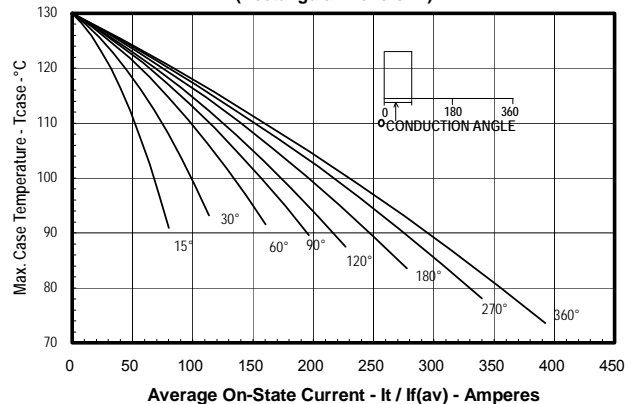

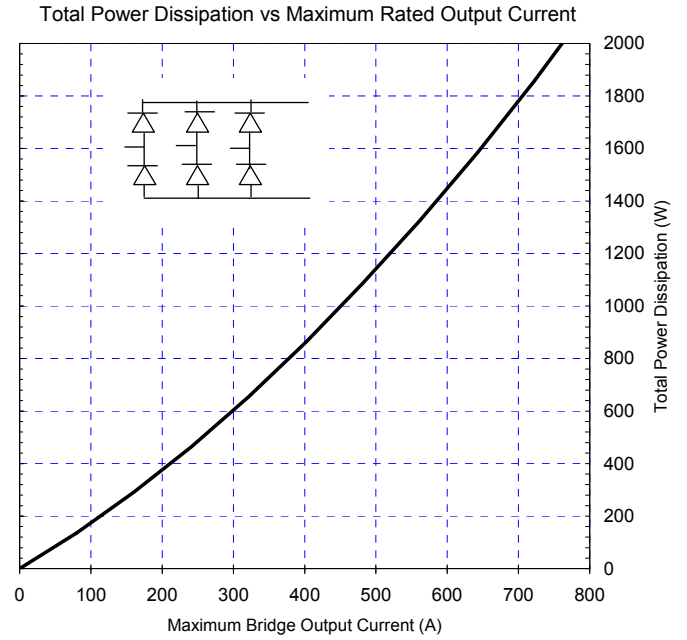
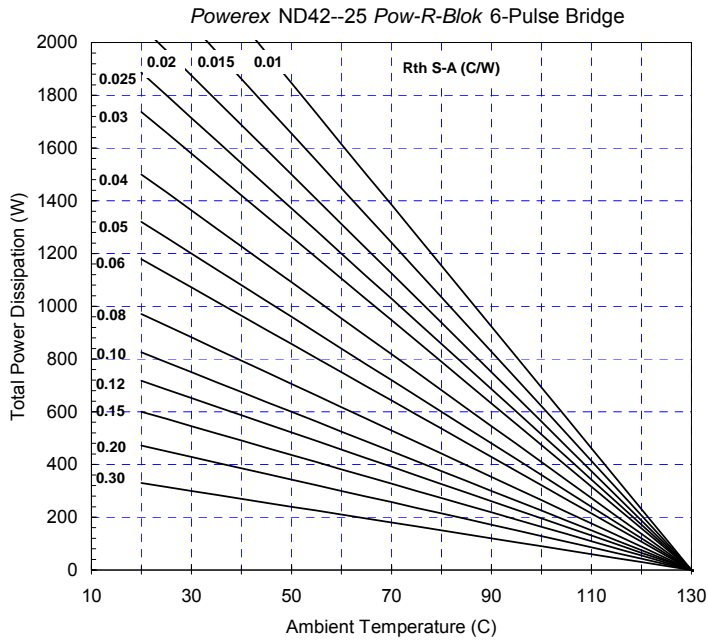

Six-Pulse Bridge Circuit Total Power Dissipation & Maximum Rated Output Current With Sink to Ambient Resistance of Heatsink as a Parameter.