

Powerex, Inc., 173 Pavilion Lane, Youngwood, Pennsylvania 15697 (724) 925-7272
www.pwr.com

POW-R-BLOK™ Dual Diode Isolated Module 350 Amperes & Up to 1700 Volts

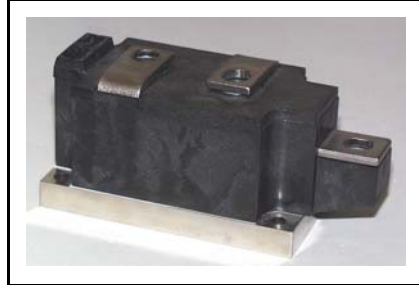
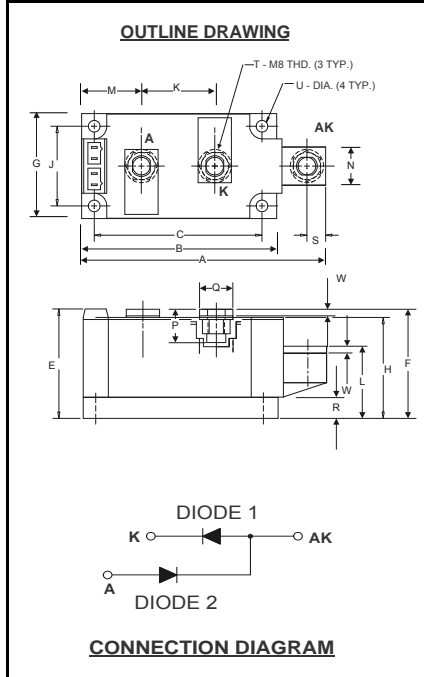

**ND41__35
Dual Diode Isolated
POW-R-BLOK™ Module
350 Amperes / 600-1700 Volts**

Description:

Powerex Dual Diode Modules are designed for use in applications requiring rectification and isolated packaging. The modules are isolated for easy mounting with other components on a common heatsink. *POW-R-BLOK™* has been tested and recognized by the Underwriters Laboratories.

Features:

- Electrically Isolated Heatsinking
- Aluminum Nitride Isolator
- Compression Bonded Elements
- Metal Baseplate
- Low Thermal Impedance for Improved Current Capability
- UL Recognized

Benefits:

- No Additional Insulation Components Required
- Easy Installation
- No Clamping Components Required
- Reduce Engineering Time

Applications:

- Bridge Circuits
- AC & DC Motor Drives
- Battery Supplies
- Power Supplies
- Large IGBT Circuit Front Ends

ND41 Outline Dimensions

Dimension	Inches	Millimeters
A	4.57	116
B	3.66	93
C	3.15	80.0
E	2.06	52.3
F	2.05	52.0
G	1.97	50.0
H	1.90	48.3
J	1.50	38.1
K	1.38	35.0
L	1.26	32.0
M	1.122	28.5
N	.71	18.0
P	.57	14.5
Q	.625	15.9
R	.394	10.00
S	.350	8.9
T	M8 Metric	M8
U	.250 Dia.	6.35 Dia.
W	.12	3.0

Note: Dimensions are for reference only.

Ordering Information:

Select the complete eight digit module part number from the table below.

Example: ND411735 is a 1700Volt, 350 Ampere Dual Diode Isolated *POW-R-BLOK™* Module

Type	Voltage Volts (x100)	Current Amperes (x10)
ND41	06 08 10 12 14 16 17	35

Absolute Maximum Ratings

Characteristics	Conditions	Symbol		Units
Repetitive Peak Reverse Blocking Voltage		V_{RRM}	up to 1700	V
Non-Repetitive Peak Reverse Blocking Voltage (t < 5 msec)		V_{RSM}	$V_{RRM} + 100$	V
RMS Forward Current	180° Conduction, $T_C=102^\circ\text{C}$	$I_{F(RMS)}$	550	A
	180° Conduction, $T_C=108^\circ\text{C}$	$I_{F(RMS)}$	510	A
	180° Conduction, $T_C=112^\circ\text{C}$	$I_{F(RMS)}$	470	A
Average Forward Current	180° Conduction, $T_C=102^\circ\text{C}$	$I_{F(AV)}$	350	A
	180° Conduction, $T_C=108^\circ\text{C}$	$I_{F(AV)}$	325	A
	180° Conduction, $T_C=112^\circ\text{C}$	$I_{F(AV)}$	300	A
Peak One Cycle Surge Current, Non-Repetitive Initial $T_j = T_j \text{ max}$	60 Hz, 100% V_{RRM} reapplied	I_{FSM}	8450	A
	60 Hz, No V_{RRM} reapplied	I_{FSM}	12,500	A
	50 Hz, 100% V_{RRM} reapplied	I_{FSM}	7340	A
	50 Hz, No V_{RRM} reapplied	I_{FSM}	11,000	A
Peak One Cycle Surge Current, Non-Repetitive Initial $T_j = 25\text{C}$	60 Hz, 100% V_{RRM} reapplied	I_{FSM}	9970	A
	60 Hz, No V_{RRM} reapplied	I_{FSM}	14,750	A
	50 Hz, 100% V_{RRM} reapplied	I_{FSM}	8670	A
	50 Hz, No V_{RRM} reapplied	I_{FSM}	13,000	A
Peak Three Cycle Surge Current, Non-Repetitive Initial $T_j = T_j \text{ max}$	60 Hz, 100% V_{RRM} reapplied	I_{FSM}	6760	A
Peak Ten Cycle Surge Current, Non-Repetitive Initial $T_j = T_j \text{ max}$	60 Hz, 100% V_{RRM} reapplied	I_{FSM}	5330	A
I^2t for Fusing for One Cycle, 8.3 milliseconds No V_{RRM} reapplied	Initial $T_j = T_j \text{ max}$	I^2t	651,000	$\text{A}^2 \text{ sec}$
	Initial $T_j = 25\text{C}$	I^2t	906,000	$\text{A}^2 \text{ sec}$
Operating Temperature		T_j	-40 to +150	$^\circ\text{C}$
Storage Temperature		T_{sig}	-40 to +150	$^\circ\text{C}$
Max. Mounting Torque, M6 Mounting Screw			45	in.-Lb.
			5	Nm
Max. Mounting Torque, M8 Terminal Screw			95	in.-Lb.
			11	Nm
Module Weight, Typical			840	g
			1.85	lb.
V Isolation @ 25C	60 seconds	V_{rms}	3000	V
	1 second	V_{rms}	3600	V

Electrical Characteristics, $T_J=25^\circ\text{C}$ unless otherwise specified

Characteristics	Symbol	Test Conditions	Min.	Max.	Units
Repetitive Peak Reverse Leakage Current	I_{RRM}	Up to 1700V, $T_J=150^\circ\text{C}$		30	mA
Peak On-State Voltage	V_{FM}	$I_{FM}=1000\text{A}$		1.20	V
Threshold Voltage, Low-level	$V_{(TO)1}$	$T_J = 150^\circ\text{C}$, $I = 15\%I_{F(AV)}$ to $\pi I_{F(AV)}$		0.654	V
Slope Resistance, Low-level	r_{T1}			0.320	m Ω
Threshold Voltage, High-level	$V_{(TO)2}$	$T_J = 150^\circ\text{C}$, $I = \pi I_{F(AV)}$ to I_{FSM}		0.726	V
Slope Resistance, High-level	r_{T2}			0.272	m Ω
V_{TM} Coefficients, Full Range		$T_J = 150^\circ\text{C}$, $I = 15\%I_{F(AV)}$ to I_{FSM}	A =	0.7304	
			B =	-0.0314	
		$V_{FM} = A + B \ln I + C I + D \text{ Sqrt } I$	C =	2.15 E-4	
			D =	7.74 E-3	
Diode Reverse Recovery Time (Typical)	t_{rr}	$I_{fm} = 1500\text{A}$, $T_p = 190 \mu\text{s}$ $di/dt = -25\text{A}/\mu\text{s}$		10	μs

Thermal Characteristics

Characteristics	Symbol		Max.	Units
Thermal Resistance, Junction to Case	$R_{\theta J-C}$	Per Module, both conducting	0.07	$^\circ\text{C}/\text{W}$
		Per Junction both conducting	0.14	$^\circ\text{C}/\text{W}$
Thermal Impedance Coefficients	$Z_{\theta J-C}$	$Z_{\theta J-C} = K_1 (1 - \exp(-t/\tau_1))$ $+ K_2 (1 - \exp(-t/\tau_2))$ $+ K_3 (1 - \exp(-t/\tau_3))$ $+ K_4 (1 - \exp(-t/\tau_4))$	$K_1 = 5.27\text{E-}3$ $K_2 = 1.17\text{E-}2$ $K_3 = 5.26\text{E-}2$ $K_4 = 6.97\text{E-}2$	$\tau_1 = 1.69\text{E-}4$ $\tau_2 = 2.07\text{E-}2$ $\tau_3 = 2.37\text{E-}1$ $\tau_4 = 2.46$
Thermal Resistance, Case to Sink Lubricated	$R_{\theta C-S}$	Per Module	0.03	$^\circ\text{C}/\text{W}$

Powerex, Inc., 173 Pavilion Lane, Youngwood, Pennsylvania 15697 (724) 925-7272
www.pwr.com

POW-R-BLOK™ Dual Diode Isolated Module 350 Amperes & Up to 1700 Volts

Typical On-State Forward Voltage Drop
(Tj = 150C)

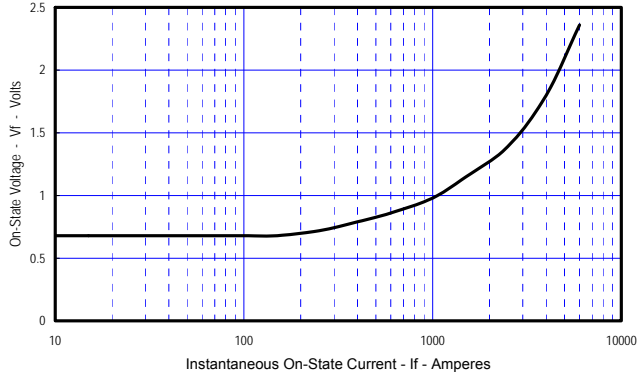

Maximum Transient Thermal Impedance
(Junction To Case)

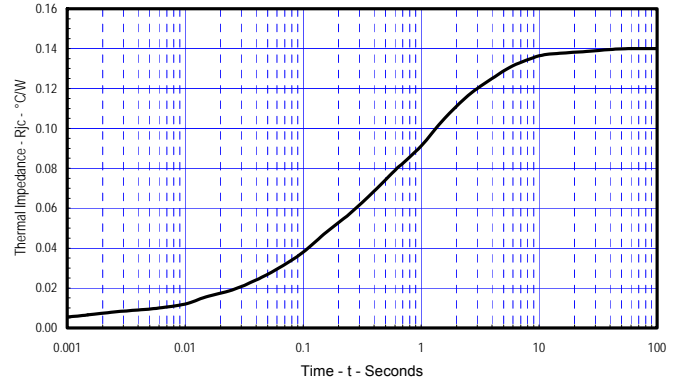

Maximum On-State Power Dissipation
(Sinusoidal Waveform)

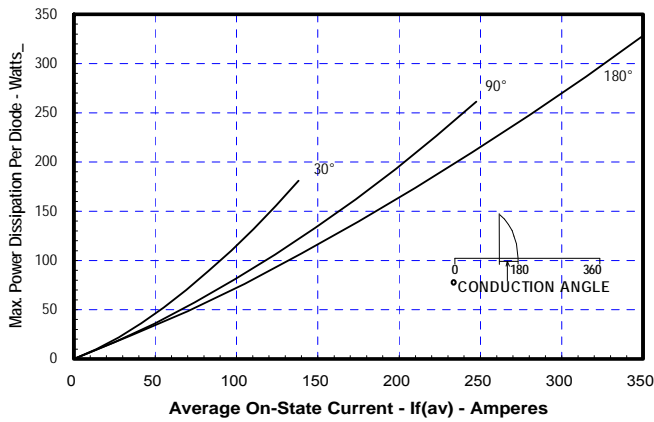

Maximum Allowable Case Temperature
(Sinusoidal Waveform)

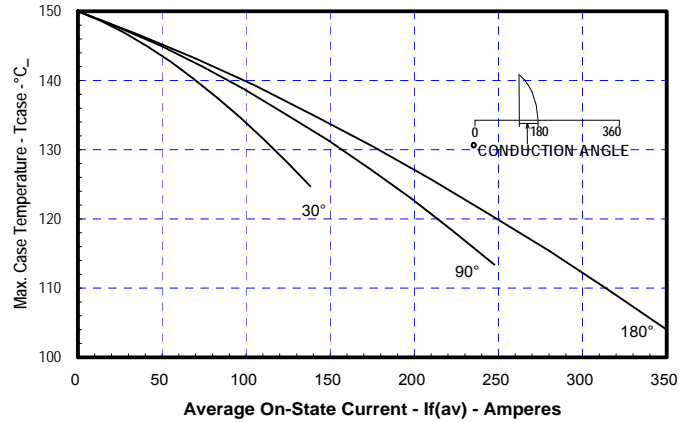

Maximum On-State Power Dissipation
(Rectangular Waveform)

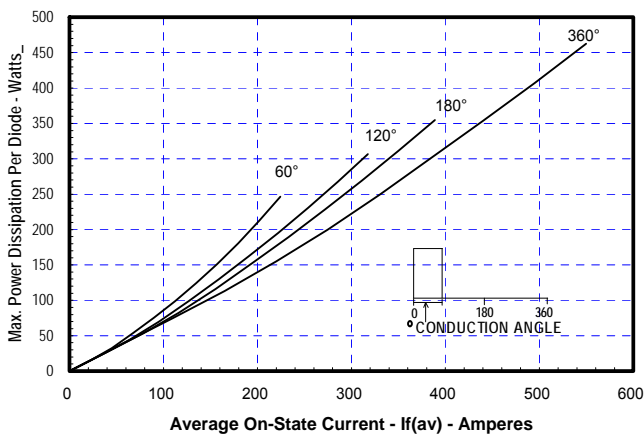

Maximum Allowable Case Temperature
(Rectangular Waveform)

