

Powerex, Inc., 173 Pavilion Lane, Youngwood, Pennsylvania 15697 (724) 925-7272
www.pwr.com

POW-R-BLOK™ Dual Diode Isolated Module Up to 320 Amperes & 2000 Volts

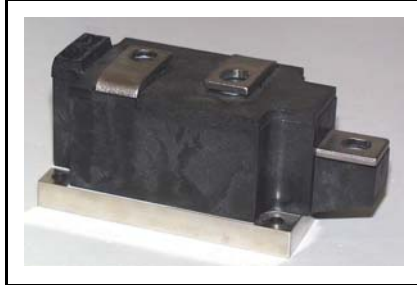
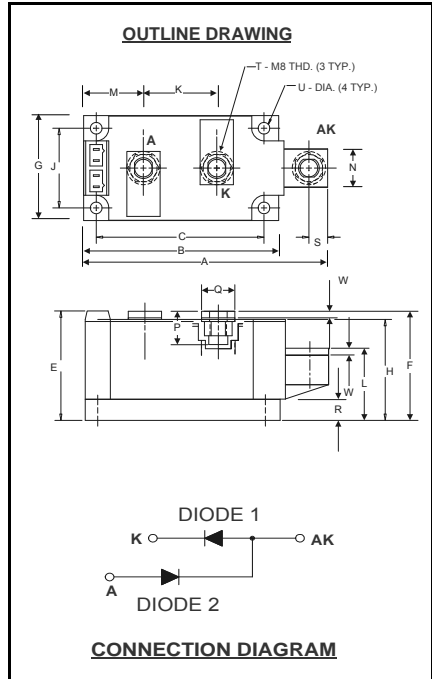

ND41__32
Dual Diode Isolated
POW-R-BLOK™ Module
200-320 Amperes / 600-2000 Volts

Description:

Powerex Dual Diode Modules are designed for use in applications requiring rectification and isolated packaging. The modules are isolated for easy mounting with other components on a common heatsink. *POW-R-BLOK™* has been tested and recognized by the Underwriters Laboratories.

Features:

- Electrically Isolated Heatsinking
- Aluminum Nitride Isolator
- Compression Bonded Elements
- Metal Baseplate
- Low Thermal Impedance for Improved Current Capability
- UL Recognized

Benefits:

- No Additional Insulation Components Required
- Easy Installation
- No Clamping Components Required
- Reduce Engineering Time

Applications:

- Bridge Circuits
- AC & DC Motor Drives
- Battery Supplies
- Power Supplies
- Large IGBT Circuit Front Ends

ND41 Outline Dimensions

| Dimension | Inches | Millimeters |
|-----------|-----------|-------------|
| A | 4.57 | 116 |
| B | 3.66 | 93 |
| C | 3.15 | 80.0 |
| E | 2.06 | 52.3 |
| F | 2.05 | 52.0 |
| G | 1.97 | 50.0 |
| H | 1.90 | 48.3 |
| J | 1.50 | 38.1 |
| K | 1.38 | 35.0 |
| L | 1.26 | 32.0 |
| M | 1.122 | 28.5 |
| N | .71 | 18.0 |
| P | .57 | 14.5 |
| Q | .625 | 15.9 |
| R | .394 | 10.00 |
| S | .350 | 8.9 |
| T | M8 Metric | M8 |
| U | .250 Dia. | 6.35 Dia. |
| W | .12 | 3.0 |

Note: Dimensions are for reference only.

Ordering Information:

Select the complete eight digit module part number from the table below.

Example: ND412032 is a 2000Volt, 320 Ampere Dual Diode Isolated *POW-R-BLOK™* Module

| Type | Voltage Volts (x100) | Current Amperes (x10) |
|------|----------------------------|-----------------------------|
| ND41 | 06 | 32 |
| | 08 | |
| | 10 | |
| | 12 | |
| | 14 | |
| | 16 | |
| | 18 | |
| | 20 | |

Absolute Maximum Ratings

| Characteristics | Conditions | Symbol | | Units |
|---|--|--------------|-----------------|--------------------------|
| Repetitive Peak Reverse Blocking Voltage | | V_{RRM} | up to 2000 | V |
| Non-Repetitive Peak Reverse Blocking Voltage (t < 5 msec) | | V_{RSM} | $V_{RRM} + 200$ | V |
| RMS Forward Current | 180° Conduction, $T_C=101^\circ\text{C}$ | $I_{F(RMS)}$ | 502 | A |
| | 180° Conduction, $T_C=105^\circ\text{C}$ | $I_{F(RMS)}$ | 470 | A |
| | 180° Conduction, $T_C=109^\circ\text{C}$ | $I_{F(RMS)}$ | 440 | A |
| | 180° Conduction, $T_C=112^\circ\text{C}$ | $I_{F(RMS)}$ | 408 | A |
| Average Forward Current | 180° Conduction, $T_C=101^\circ\text{C}$ | $I_{F(AV)}$ | 320 | A |
| | 180° Conduction, $T_C=105^\circ\text{C}$ | $I_{F(AV)}$ | 300 | A |
| | 180° Conduction, $T_C=109^\circ\text{C}$ | $I_{F(AV)}$ | 280 | A |
| | 180° Conduction, $T_C=112^\circ\text{C}$ | $I_{F(AV)}$ | 260 | A |
| Peak One Cycle Surge Current, Non-Repetitive Initial $T_j = T_j \text{ max}$ | 60 Hz, 100% V_{RRM} reapplied | I_{FSM} | 8000 | A |
| | 60 Hz, No V_{RRM} reapplied | I_{FSM} | 10,000 | A |
| Peak Three Cycle Surge Current, Non-Repetitive | 60 Hz, 100% V_{RRM} reapplied | I_{FSM} | 5750 | A |
| Peak Ten Cycle Surge Current, Non-Repetitive | 60 Hz, 100% V_{RRM} reapplied | I_{FSM} | 4975 | A |
| I^2t for Fusing for One Cycle, 8.3 milliseconds | | I^2t | 266,000 | $\text{A}^2 \text{ sec}$ |
| Operating Temperature | | T_J | -40 to +150 | $^\circ\text{C}$ |
| Storage Temperature | | T_{stg} | -40 to +150 | $^\circ\text{C}$ |
| Max. Mounting Torque, M6 Mounting Screw | | | 45 | in.-Lb. |
| | | | 5 | Nm |
| Max. Mounting Torque, M8 Terminal Screw | | | 95 | in.-Lb. |
| | | | 11 | Nm |
| Module Weight, Typical | | | 840 | g |
| | | | 1.85 | lb. |
| V Isolation @ 25C | | V_{rms} | 2500 | V |

Electrical Characteristics, $T_J=25^\circ\text{C}$ unless otherwise specified

| Characteristics | Symbol | Test Conditions | Min. | Max. | Units |
|---|-------------|--|------|-----------|------------------|
| Repetitive Peak Reverse Leakage Current | I_{RRM} | Up to 2000V, $T_J=150^\circ\text{C}$ | | 50 | mA |
| Peak On-State Voltage | V_{FM} | $I_{FM}=1500\text{A}$ | | 1.35 | V |
| Threshold Voltage, Low-level | $V_{(TO)1}$ | $T_J = 150^\circ\text{C}$, $I = 15\%I_{F(AV)}$ to $\pi I_{F(AV)}$ | | 0.764 | V |
| Slope Resistance, Low-level | r_{T1} | | | 0.360 | $\text{m}\Omega$ |
| Threshold Voltage, High-level | $V_{(TO)2}$ | $T_J = 150^\circ\text{C}$, $I = \pi I_{F(AV)}$ to I_{FSM} | | 0.710 | V |
| Slope Resistance, High-level | r_{T2} | | | 0.420 | $\text{m}\Omega$ |
| V_{TM} Coefficients, Full Range | | $T_J = 150^\circ\text{C}$, $I = 15\%I_{F(AV)}$ to I_{FSM} | A = | 0.7144 | |
| | | | B = | 0.0232 | |
| | | $V_{FM} = A + B \ln I + C I + D \text{ Sqrt } I$ | C = | 4.72 E-4 | |
| | | | D = | -6.71 E-3 | |
| Diode Reverse Recovery Time (Typical) | t_{rr} | $I_{fm} = 1500\text{A}$, $T_p = 190 \mu\text{s}$ $di/dt = -25\text{A}/\mu\text{s}$ | | 10 | μs |

Thermal Characteristics

| Characteristics | Symbol | | Max. | Units |
|---|------------------|---|--|--|
| Thermal Resistance, Junction to Case | $R_{\theta J-C}$ | Per Module, both conducting Per Junction both conducting | 0.07 0.14 | $^\circ\text{C}/\text{W}$ $^\circ\text{C}/\text{W}$ |
| Thermal Impedance Coefficients | $Z_{\theta J-C}$ | $Z_{\theta J-C} = K_1 (1 - \exp(-t/\tau_1))$ $+ K_2 (1 - \exp(-t/\tau_2))$ $+ K_3 (1 - \exp(-t/\tau_3))$ $+ K_4 (1 - \exp(-t/\tau_4))$ | $K_1 = 5.27\text{E-}3$ $K_2 = 1.17\text{E-}2$ $K_3 = 5.26\text{E-}2$ $K_4 = 6.97\text{E-}2$ | $\tau_1 = 1.69\text{E-}4$ $\tau_2 = 2.07\text{E-}2$ $\tau_3 = 2.37\text{E-}1$ $\tau_4 = 2.46$ |
| Thermal Resistance, Case to Sink Lubricated | $R_{\theta C-S}$ | Per Module | 0.03 | $^\circ\text{C}/\text{W}$ |

Powerex, Inc., 173 Pavilion Lane, Youngwood, Pennsylvania 15697 (724) 925-7272
www.pwr.com

POW-R-BLOCK™ Dual Diode Isolated Module Up to 320 Amperes & 2000 Volts

Maximum On-State Forward Voltage Drop
(T_J = 150 °C)

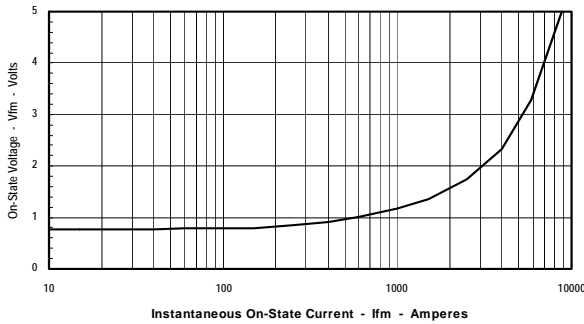

Maximum Transient Thermal Impedance
(Junction to Case)

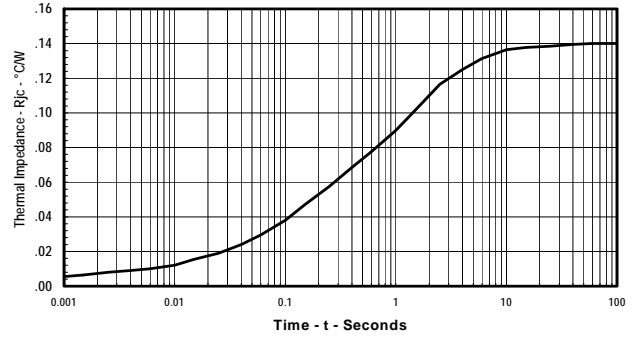

Maximum On-State Power Dissipation
(Sinusoidal Waveform)

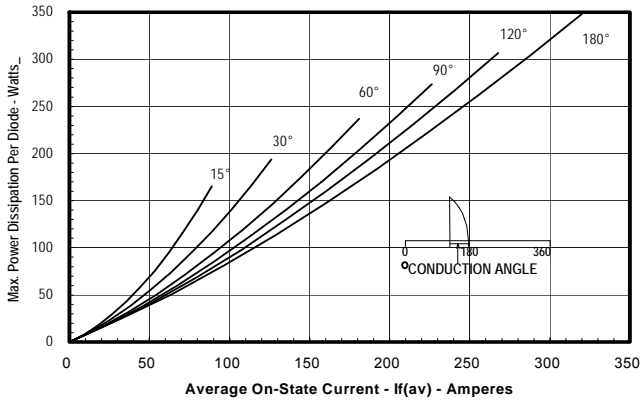

Maximum Allowable Case Temperature
(Sinusoidal Waveform)

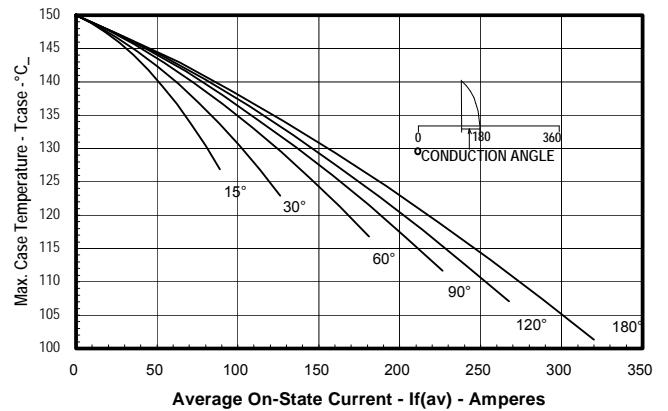

Maximum On-State Power Dissipation
(Rectangular Waveform)

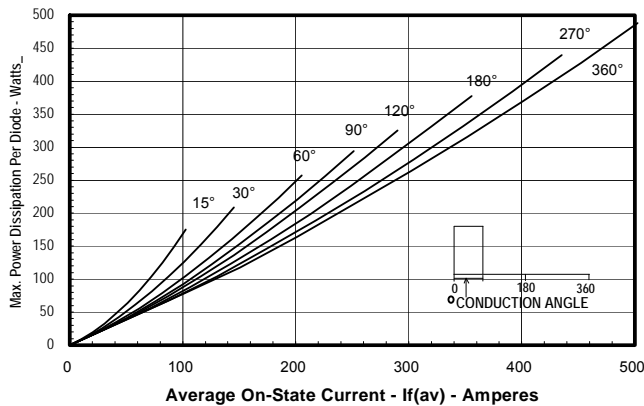

Maximum Allowable Case Temperature
(Rectangular Waveform)

