

Powerex, Inc., 173 Pavilion Lane, Youngwood, Pennsylvania 15697 (724) 925-7272  
www.pwr.com

### POW-R-BLOK™ Dual Diode Isolated Module 260 Amperes / Up to 2400 Volts

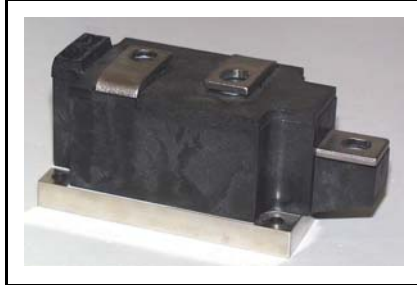
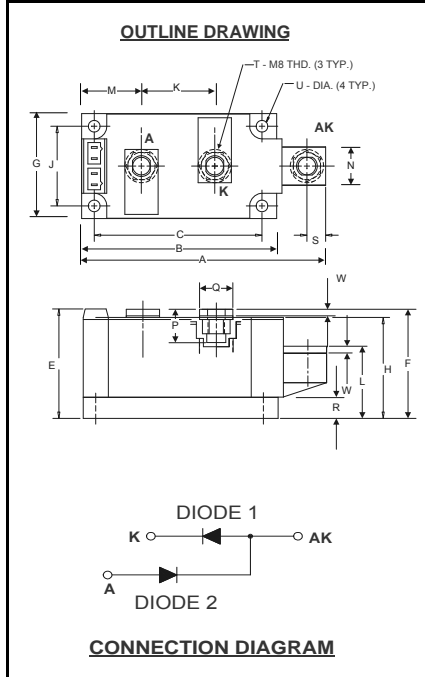

**ND41\_\_26**  
**Dual Diode Isolated**  
**POW-R-BLOK™ Module**  
260 Amperes / 600-2400 Volts

#### Description:

Powerex Dual Diode Modules are designed for use in applications requiring rectification and isolated packaging. The modules are isolated for easy mounting with other components on a common heatsink. *POW-R-BLOK™* has been tested and recognized by the Underwriters Laboratories.

#### Features:

- Electrically Isolated Heatsinking
- Aluminum Nitride Isolator
- Compression Bonded Elements
- Metal Baseplate
- Low Thermal Impedance for Improved Current Capability
- UL Recognized

#### Benefits:

- No Additional Insulation Components Required
- Easy Installation
- No Clamping Components Required
- Reduce Engineering Time

#### Applications:

- Bridge Circuits
- AC & DC Motor Drives
- Battery Supplies
- Power Supplies
- Large IGBT Circuit Front Ends

#### ND41 Outline Dimensions

Dimension	Inches	Millimeters
A	4.57	116
B	3.66	93
C	3.15	80.0
E	2.06	52.3
F	2.05	52.0
G	1.97	50.0
H	1.90	48.3
J	1.50	38.1
K	1.38	35.0
L	1.26	32.0
M	1.122	28.5
N	.71	18.0
P	.57	14.5
Q	.625	15.9
R	.394	10.00
S	.350	8.9
T	M8 Metric	M8
U	.250 Dia.	6.35 Dia.
W	.12	3.0

Note: Dimensions are for reference only.

#### Ordering Information:

Select the complete eight digit module part number from the table below.

Example: ND412026 is a 2000Volt, 260 Ampere Dual Diode Isolated *POW-R-BLOK™* Module

Type	Voltage Volts (x100)	Current Amperes (x10)
ND41	06	26
	08	
	10	
	12	
	14	
	16	
	18	
	20	
	22	
	24	

**Absolute Maximum Ratings**

Characteristics	Conditions	Symbol		Units
Repetitive Peak Reverse Blocking Voltage		$V_{RRM}$	up to 2400	V
Non-Repetitive Peak Reverse Blocking Voltage ( $t < 5$ msec)		$V_{RSM}$	$V_{RRM} + 200$	V
RMS Forward Current	180° Conduction, $T_C=112^\circ\text{C}$	$I_{F(RMS)}$	408	A
Average Forward Current	180° Conduction, $T_C=112^\circ\text{C}$	$I_{F(AV)}$	260	A
Peak One Cycle Surge Current, Non-Repetitive	60 Hz, 100% $V_{RRM}$ reapplied	$I_{FSM}$	8000	A
Peak Three Cycle Surge Current, Non-Repetitive	60 Hz, 100% $V_{RRM}$ reapplied	$I_{FSM}$	5750	A
Peak Ten Cycle Surge Current, Non-Repetitive	60 Hz, 100% $V_{RRM}$ reapplied	$I_{FSM}$	4975	A
$I^2t$ for Fusing for One Cycle, 8.3 milliseconds		$I^2t$	266,000	$\text{A}^2 \text{sec}$
Operating Temperature		$T_J$	-40 to +150	$^\circ\text{C}$
Storage Temperature		$T_{stg}$	-40 to +150	$^\circ\text{C}$
Max. Mounting Torque, M6 Mounting Screw			45 5	in.-Lb. Nm
Max. Mounting Torque, M8 Terminal Screw			110 12	in.-Lb. Nm
Module Weight, Typical			840 1.85	g lb.
V Isolation @ 25C		$V_{rms}$	2500	V

**Electrical Characteristics, T<sub>J</sub>=25°C unless otherwise specified**

Characteristics	Symbol	Test Conditions	Min.	Max.	Units
Repetitive Peak Reverse Leakage Current	I <sub>RRM</sub>	Up to 2400V, T <sub>J</sub> =150°C		50	mA
Peak On-State Voltage	V <sub>FM</sub>	I <sub>FM</sub> =1500A		1.35	V
Threshold Voltage, Low-level	V <sub>(TO)1</sub>	T <sub>J</sub> = 150°C, I = 15%I <sub>F(AV)</sub> to πI <sub>F(AV)</sub>		0.764	V
Slope Resistance, Low-level	r <sub>T1</sub>			0.360	mΩ
Threshold Voltage, High-level	V <sub>(TO)2</sub>	T <sub>J</sub> = 150°C, I = πI <sub>F(AV)</sub> to I <sub>FSM</sub>		.710	V
Slope Resistance, High-level	r <sub>T2</sub>			0.420	mΩ
V <sub>TM</sub> Coefficients, Full Range		T <sub>J</sub> = 150°C, I = 15%I <sub>F(AV)</sub> to I <sub>FSM</sub>	A =	0.7140	
			B =	0.0232	
		V <sub>FM</sub> = A+ B Ln I + C I + D Sqrt I	C =	4.72 E-4	
			D =	-6.71 E-3	
Diode Reverse Recovery Time (Typical)	t <sub>rr</sub>	I <sub>fm</sub> = 1500A, T <sub>p</sub> = 190 μs di/dt = -25A/μs		10	μs

**Thermal Characteristics**

Characteristics	Symbol		Max.	Units
Thermal Resistance, Junction to Case	R <sub>ΘJ-C</sub>	Per Module, both conducting Per Junction both conducting	0.07 0.14	°C/W °C/W
Thermal Impedance Coefficients	Z <sub>ΘJ-C</sub>	Z <sub>ΘJ-C</sub> = K <sub>1</sub> (1-exp(-t/τ <sub>1</sub> )) + K <sub>2</sub> (1-exp(-t/τ <sub>2</sub> )) + K <sub>3</sub> (1-exp(-t/τ <sub>3</sub> )) + K <sub>4</sub> (1-exp(-t/τ <sub>4</sub> ))	K <sub>1</sub> = 5.27E-3 K <sub>2</sub> = 1.17E-2 K <sub>3</sub> = 5.26E-2 K <sub>4</sub> = 6.97E-2	τ <sub>1</sub> = 1.69E-4 τ <sub>2</sub> = 2.07E-2 τ <sub>3</sub> = 2.37E-1 τ <sub>4</sub> = 2.46
Thermal Resistance, Case to Sink Lubricated	R <sub>ΘC-S</sub>	Per Module	0.03	°C/W

Powerex, Inc., 173 Pavilion Lane, Youngwood, Pennsylvania 15697 (724) 925-7272  
www.pwr.com

## POW-R-BLOK™ Dual Diode Isolated Module 260 Amperes / Up to 2400 Volts

**Maximum On-State Forward Voltage Drop**  
( $T_J = 150^\circ\text{C}$ )

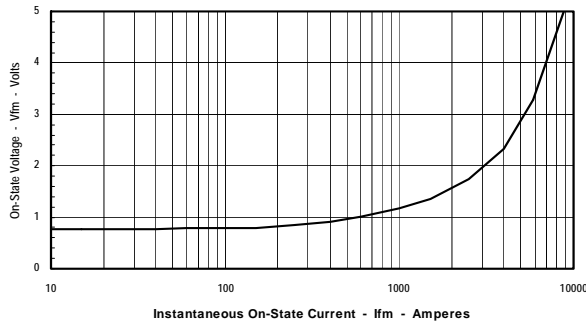

**Maximum Transient Thermal Impedance**  
(Junction to Case)

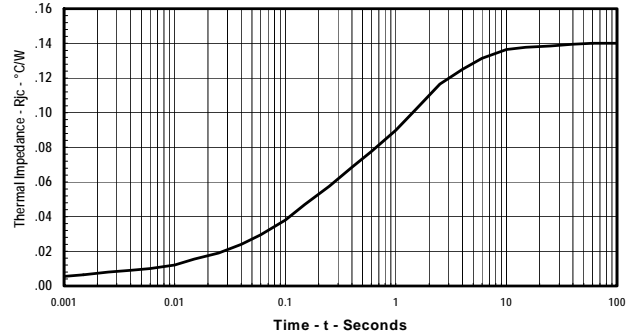

**Maximum On-State Power Dissipation**  
(Sinusoidal Waveform)

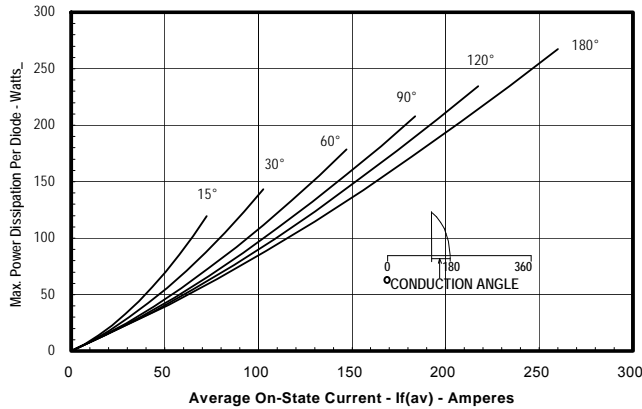

**Maximum Allowable Case Temperature**  
(Sinusoidal Waveform)

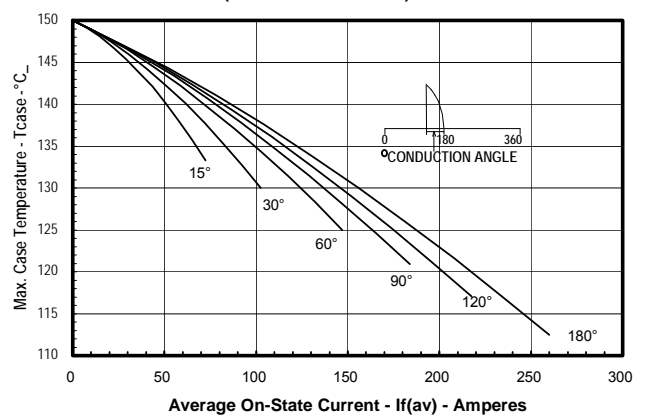

**Maximum On-State Power Dissipation**  
(Rectangular Waveform)

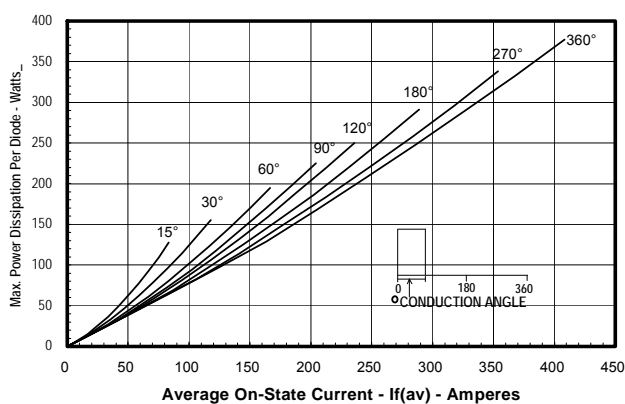

**Maximum Allowable Case Temperature**  
(Rectangular Waveform)

