

PRELIMINARY
 Notice: This is not a final specification.
 Some parametric limits are subject to change.

M63832GP/KP

7-UNIT 500mA DARLINGTON TRANSISTOR-ARRAY

DESCRIPTION

The M63832GP/KP 7-channel sinkdriver, consists of 7 PNP and 14 NPN transistors connected to form seven high current gain driver pairs.

FEATURES

- High breakdown voltage ($BV_{CEO} \geq 50V$)
- High-current driving ($I_{C(max)} = 500mA$)
- 3V micro computer compatible input
- "L" active level input
- With input diode
- Wide operating temperature range ($T_a = -40$ to $+85^\circ C$)

APPLICATION

Output for 3 voltage microcomputer series and interface with high voltage system. Relay and small printer driver, LED, or incandescent display digit driver.

FUNCTION

The M63832GP/KP is transistor-array of high active level seven units type which can do direct drive of 3 voltage micro-computer series. A resistor of $3.5k\Omega$ is connected between the input and the base of PNP transistors. The input diode is intended to prevent the flow of current from the input to the Vcc. Without this diode, the current flows from "H" input to the Vcc and the "L" input circuit is activated, in such a case where one of the inputs of the 7 circuit is "H" and the other are "L" to save power consumption. The diode is inserted to prevent such mis-operation. The outputs are capable of driving 500mA and are rated for operation with output voltage up to 50V.

PIN CONFIGURATION

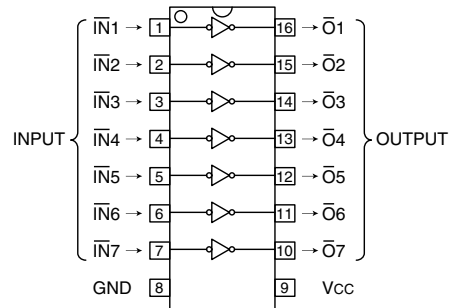

16P2S-A(GP)
 Package type 16P2Z-A(KP)

CIRCUIT DIAGRAM

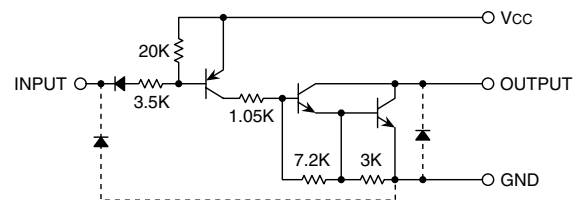

The seven circuits share the Vcc and GND

The diode, indicated with the dotted line, is parasitic, and cannot be used.

Unit : Ω

ABSOLUTE MAXIMUM RATINGS (Unless otherwise noted, $T_a = -40 \sim +85^\circ C$)

| Symbol | Parameter | Conditions | Ratings | Unit |
|------------------|---------------------------|--|-------------------|------|
| Vcc | Supply voltage | | 7 | V |
| V _{CEO} | Collector-emitter voltage | Output, H | -0.5 ~ +50 | V |
| I _C | Collector current | Current per circuit output, L | 500 | mA |
| V _I | Input voltage | | -0.5 ~ Vcc | V |
| P _d | Power dissipation | T _a = 25°C, when mounted on board | 0.80(FP)/0.78(KP) | W |
| T _{opr} | Operating temperature | | -40 ~ +85 | °C |
| T _{stg} | Storage temperature | | -55 ~ +125 | °C |

PRELIMINARY
 Notice: This is not a final specification.
 Some parametric limits are subject to change.

7-UNIT 500mA DARLINGTON TRANSISTOR-ARRAY

RECOMMENDED OPERATING CONDITIONS (Unless otherwise noted, Ta = -40 ~ +85°C)

| Symbol | Parameter | Limits | | | Unit | |
|--------|--|-------------------------------------|-----|---------|------|----|
| | | min | typ | max | | |
| Vcc | Supply voltage | 2.7 | 3.0 | 3.6 | V | |
| Ic | Collector current (Current per 1 circuit when 7 circuits are coming on simultaneously) | Duty Cycle GP/KP : no more than 2% | 0 | — | 400 | mA |
| | | Duty Cycle GP/KP : no more than 10% | 0 | — | 200 | |
| VIH | "H" input voltage | Vcc-0.5 | — | Vcc | V | |
| VIL | "L" input voltage | 0 | — | Vcc-2.2 | V | |

ELECTRICAL CHARACTERISTICS (Unless otherwise noted, Ta = -40 ~ +85°C)

| Symbol | Parameter | Test conditions | Limits | | | Unit |
|------------|--------------------------------------|---|--------|-------|------|------|
| | | | min | typ* | max | |
| V (BR) CEO | Collector-emitter breakdown voltage | ICEO = 100µA | 50 | — | — | V |
| VCE(sat) | Collector-emitter saturation voltage | VCC = 2.7V, VI = 0.5V, IC = 400mA | — | 1.15 | 2.4 | V |
| | | VCC = 2.7V, VI = 0.5V, IC = 200mA | — | 0.93 | 1.6 | |
| Ii | Input current | VI = VCC-2.2V | — | -220 | -600 | µA |
| ICC | Supply current (AN only Input) | VCC = 3.6V, VI = 0.5V | — | 2.6 | 4.0 | mA |
| hFE | DC amplification factor | VCC = 2.7V, VCE = 2V, IC = 0.35A, Ta = 25°C | 2000 | 10000 | — | — |

* : Typical values are at Ta = 25°C

SWITCHING CHARACTERISTICS (Unless otherwise noted, Ta = 25°C)

| Symbol | Parameter | Test conditions | Limits | | | Unit |
|--------|---------------|--------------------|--------|------|-----|------|
| | | | min | typ | max | |
| ton | Turn-on time | CL = 15pF (note 1) | — | 120 | — | ns |
| toff | Turn-off time | | — | 4500 | — | |

NOTE 1 TEST CIRCUIT

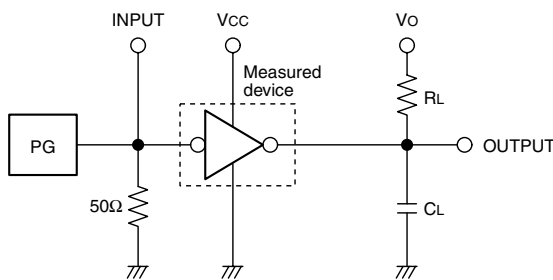

- (1) Pulse generator (PG) characteristics : PRR=1kHz, tw = 10µs, tr = 6ns, tf = 6ns, Zo = 50Ω, VI = 0.5 ~ 2.7V
- (2) Input-output conditions : RL = 30Ω, Vo = 10V, Vcc = 2.7V
- (3) Electrostatic capacity CL includes floating capacitance at connections and input capacitance at probes

TIMING DIAGRAM

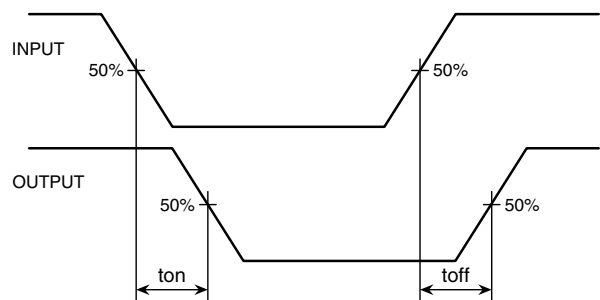

PRELIMINARY
 Notice: This is not a final specification.
 Some parametric limits are subject to change.

TYPICAL CHARACTERISTICS

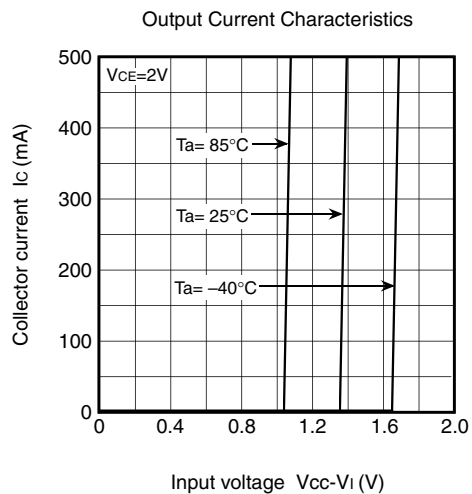
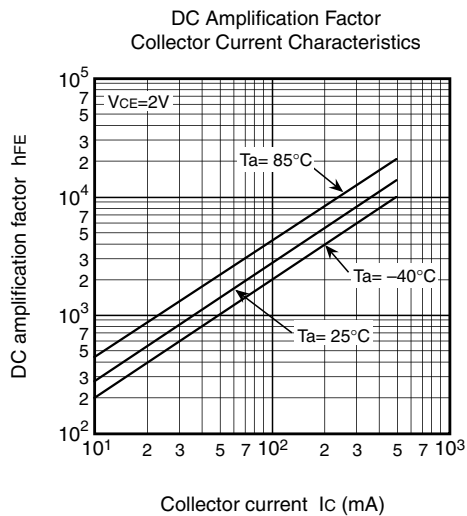
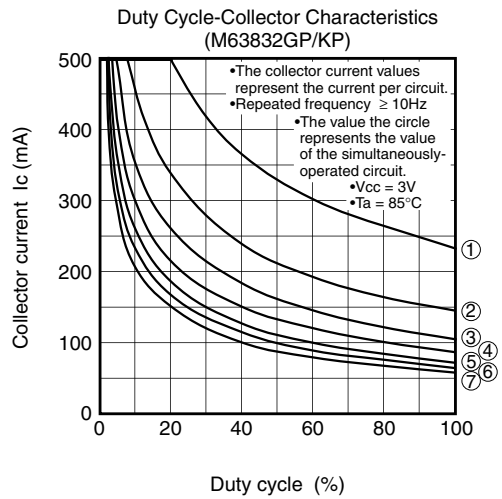
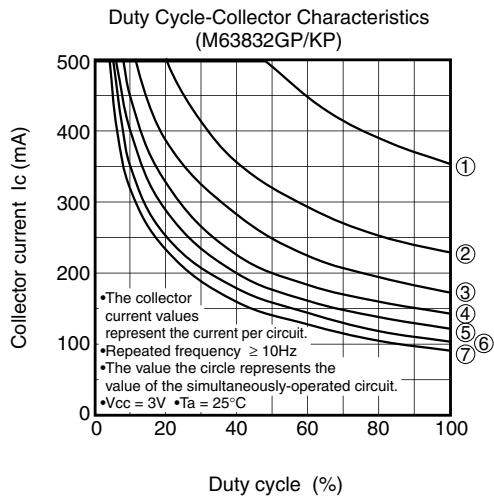
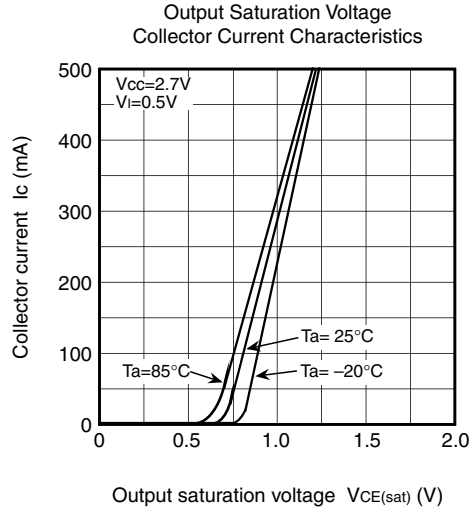
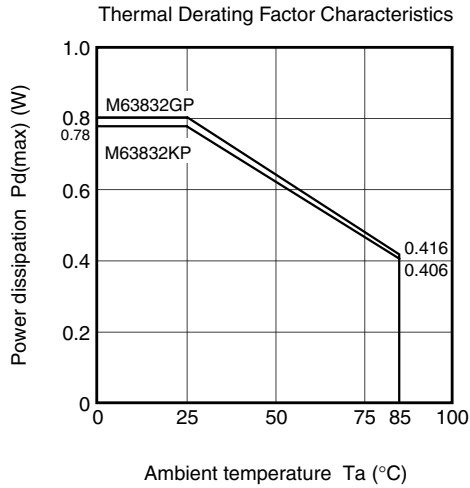

PRELIMINARY
 Notice: This is not a final specification.
 Some parametric limits are subject to change.

Input Characteristics

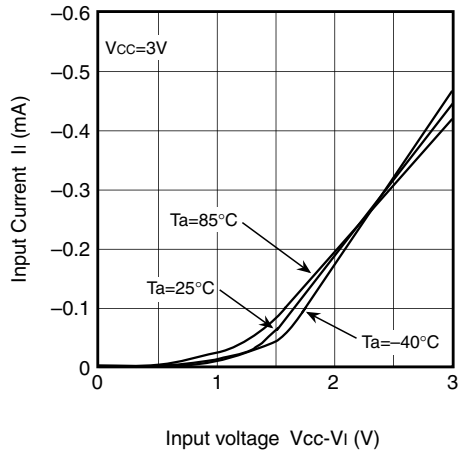

Driver Supply Characteristics

